

Top[®]
Light

LIGHT FOR LIVING

2021/2022



Design by[®]

R
Z
Raif Ziel

Ausgezeichnete Leuchten in bestem Design



INDUSTRIEPREIS
2015



PLUS X AWARD
2015/2016



PLUS X AWARD
2016/2017



LICHT + CONCEPT
LIEFERANT DES JAHRES
2016



PLUS X AWARD
2016/2017



PLUS X AWARD
2017/2018



PLUS X AWARD
2018



HOME TREND AWARD
2017/2018



GERMAN DESIGN AWARD
2019



LICHT + CONCEPT
LIEFERANT DES JAHRES
2020



GERMAN BRAND AWARD
2020



GERMAN BRAND AWARD
EXCELLENT BRANDS LIGHTING
2021



GERMAN BRAND AWARD
PRODUCT BRAND OF THE YEAR
2021



PLUS X AWARD
2021/2022

Top Light Infos & Icons

Alle LED Leuchtmittel der früheren Energieeffizienzklasse »A bis A++« werden nach der neuen Verordnung in die Energieeffizienzklasse »G bis F« eingestuft. Wir behalten uns vor, dass techn. Angaben und Preise der Leuchtmittel sich aufgrund der techn. Weiterentwicklung ändern können. Sowohl bei bestellen, als auch bei den von Top Light beigelegten Leuchtmitteln. Nicht alle Retrofits sind dimmbar. LED-Retrofit auch im Handel erhältlich.

All LED illuminants of the former energy efficiency class A to A++ are classified in the energy efficiency class G to F according to the new regulation. We reserve the right to change the technical specifications and prices of the lamps due to technical developments. This applies to both the illuminants ordered and those supplied by Top Light. Not all retrofits are dimmable. LED retrofits are also available in stores.

	Kennzeichnung zur Konformitätserklärung des Herstellers über die Einhaltung bestehender EG-Richtlinien.	Proof of manufacturer's conformity with existing European directives.
	IP (Ingress Protection), Schutzart-Klassifizierung IP20 = Geschützt gegen das Eindringen von festen Fremdkörpern > 12 mm.	IP (Ingress Protection), Protection classification IP20 = Protected against ingress by solid foreign objects > 12 mm.
	Schutzklasse I: Leuchten mit Schutzleiteranschluss.	Protection class I: Lamps with earth conductor connection.
	Schutzklasse II: Leuchten mit einer zusätzlichen oder verstärkten Schutzisolierung.	Protection class II: Lamps with additional or reinforced protective insulation.
	Schutzklasse III: Leuchten im Niedervoltbereich.	Protection class III: Lamps in low-voltage range.
	IP (Ingress Protection), Schutzart-Klassifizierung IP44 = Geschützt gegen das Eindringen von festen Fremdkörpern > 1 mm und gegen Spritzwasser aus allen Richtungen.	IP (Ingress Protection), Protection classification IP44 = Protected against ingress by solid foreign objects > 1 mm and against splashing water from any direction.
	Dimmbar mit Standard-Phasenabschnittdimmer für Glühlampen.	Dimmable with standard leading edge dimmer for incandescent lamps.
	Dimmbar mit Standard-Phasenabschnittdimmer für LED.	Dimmable with standard leading edge dimmer for LED.
	Dimmbar mit Standard-Phasenabschnittdimmer für elektronische Transformatoren.	Dimmable with standard leading edge dimmer for electronic transformers.
	Vorschaltgerät ist mit 1- 10V-Steuerggerät dimmbar.	Ballast is dimmable with a 1 - 10V control unit.
	Vorschaltgerät ist mit DALI-Steuerggerät dimmbar.	Ballast is dimmable with a DALI control unit.
	Separater Lichtschalter am Leuchtgehäuse.	Separate light switch on lamp housing.
	Elektronischer Transformator.	Electronic transformer.
	Elektronisches Vorschaltgerät (EVG).	Electronic ballast.
	Vorschaltgerät ist ausgelegt für zwei unterschiedliche Wattagen.	Ballast can operate two different wattages.

Casambi-Bau-Varianten:

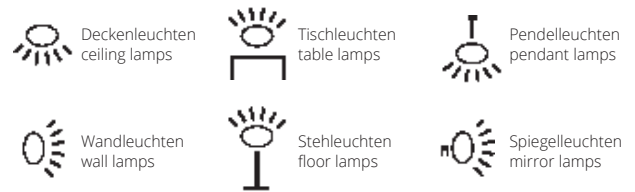

Energieeffizienzklassen

Alle angegebenen Energieeffizienzklassen rangieren auf einer Skala von A (sehr effizient) bis G (weniger effizient).



Für unsere LED Leuchten empfehlen wir folgende Dimmer:
For our LED lamps we recommend the following dimmer:

- Eltako EUD61NPN-UC (mit serienmäßigem Taster einsetzbar)
- Theben Dimax 544 plus p

Dimmen über Smarthome: Casambi TED

Austauschbare Leuchtmittel

Mit den Retro Fits wurden LED-Ersatzleuchtmittel ähnlicher Baugröße, wie die Halogenleuchtmittel geschaffen. Die rasche Entwicklung der LED Technik hat zur Konsequenz, dass auch die Leuchtmittel permanent angepasst werden müssen. Diese Anpassungen finden regelmäßig, fast halbjährlich statt. Abweichungen der Leuchtmittel lassen sich aus diesem Grund nicht vermeiden. Leuchtmittel, die wir zu unseren Produkten beilegen, sind kostenlose Beigaben und stellen keinen Anspruch dar. Sie sind Betriebsmittel und unterliegen keiner Gewährleistung. Wir arbeiten aber ständig daran, einen hohen Qualitätsanspruch zu erreichen.

Replaceable illuminants

The rapid development of LED technology means that the light sources also have to be permanently adapted. These adjustments take place regularly, almost every six months. For this reason, deviations of the lamps cannot be avoided. Illuminants that we enclose with our products are free of charge and do not constitute a claim. They are operating materials and are not subject to any warranty. However, we are constantly working to achieve a high standard of quality.

In diesem Katalog gezeigte Farben sind ein Hinweis auf das optische Finish und keine Eigenschaftszusicherung. Für die Richtigkeit von technischen Angaben, sowie Farbabweichungen, wird keine Gewähr übernommen. Alle Maßangaben sind unverbindlich und können geringfügige Abweichungen aufweisen. Technische Änderungen vorbehalten!

Colours shown in this catalogue are an indication of the visual finish and not a guarantee of characteristic. No responsibility is taken for the correctness of the technical specifications or for colour deviations. All dimensions are non-binding and may show slight deviations. We reserve the right to make technical changes!



So bestelle ich.

1. Wenn Sie bereits eine unserer Leuchten besitzen und das Lighting Control Modul nachrüsten möchten, müssen Sie unbedingt bei der Bestellung Modell und Artikelnr. der vorhandenen Leuchte angeben.
2. Bestellen Sie eine neue Leuchte und möchten das Lighting Control Modul integriert haben, dann geben Sie zu der Artikelnr. der Leuchte die Artikelnr. der gewünschten Modul Variante an.

How to order.

1. In case you already own lights of Top Light and want to equip them with Lighting Control, please indicate your type of lamp and item number with the order of the Lighting Control Modul.
2. In case you want to order a new lamp with integrated Lighting Control Module, please indicate the lamp and item number as well as the Control version you need.

Welche Leuchten funktionieren mit dem Modul?

Dieses Zeichen finden Sie auf den Seiten der Leuchten, die mit der Lighting Control ausgestattet werden können. Der oder die jeweiligen Buchstaben geben an, welche der vier aufgeführten Varianten realisierbar ist (s. rechte Seite).

Which lamp works with the modul?

All lightning fixtures which can be equipped with Lightning Control are marked with the following logo on each page. The letter indicates which of the four versions is possible for the lamp (see right page).



Modul-Kennung
auf allen
Produktseiten

Top Light Lighting Control

Ermöglicht über Bluetooth das Dimmen, Schalten und Steuern einzelner Leuchten oder Leuchtengruppen, sowie das Programmieren von Lichtszenen für das perfekte Wohlfühllicht. Außerdem bietet die Zeitschaltung Sicherheit bei Abwesenheit.

Enables via Bluetooth to dim, switch and control individual luminaires or luminaire groups, as well as to programme light scenes for the perfect feel-good light. In addition, the time switch offers security in case of absence.

Modul-Kennung für Ihre Top Light Leuchte

Passend für alle Wand-, Decken-, Pendelleuchtenmontagen und für alle Spiegel, möglich auch für Steh- und Tischleuchten.
Fits for all wall, ceiling and pendula lamp mounting and for all illuminated mirrors, also available for floor and table lamps.



- | | | | | |
|---|--|---|---|--|
| <p>A Aufbau Variante
integriert oder nachrüstbar, inkl. Baldachinanpassung mit Modul.
Mounted version
Integrated and upgradable</p> | <p>B Einbauvariante
Schalterdose/ U-Dose extern, inkl. Abdeckplatte und Modul.
Recessed version
Switch box U-Box /external</p> | <p>C Einbauvariante
extern für Hohlwanddeckenmontage, inkl. Modul
Recessed version
external</p> | <p>D Einbauvariante
intern im Wandschild, inkl. Modul
Recessed version
Included in wall- shield, incl. module</p> | <p>D SPIEGEL-Variante
Einbau hinter dem Spiegel, inkl. Modul
Mirror version
Included behind the mirror, incl. module</p> |
|---|--|---|---|--|

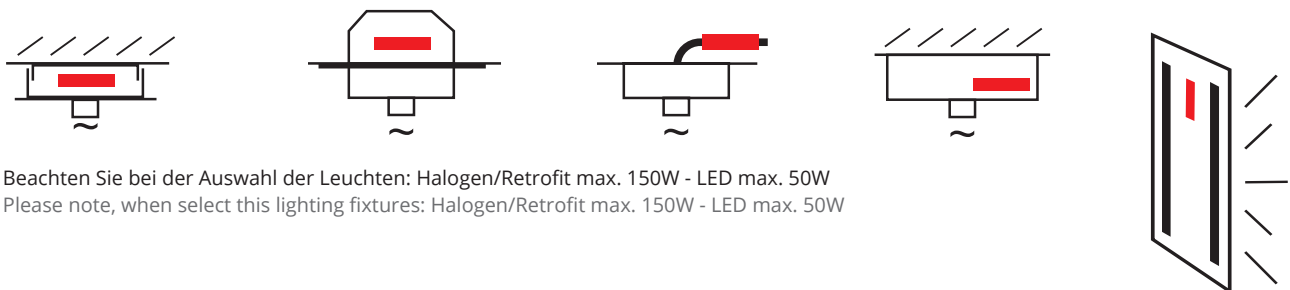

Beachten Sie bei der Auswahl der Leuchten: Halogen/Retrofit max. 150W - LED max. 50W
Please note, when select this lighting fixtures: Halogen/Retrofit max. 150W - LED max. 50W

Preise und Bestellnummern Prices and item-numbers

A	B	C	D	Gehäuse body
A. Modul integriert integrated	B. Modul Einbau recessed	C. Modul extern external	D. Modul integriert integrated	white
7-971	7-972	7-973	7-974	
Fernbedienung portabel + Wandhalterung Remote portable + wall holder			Gehäuse body	
7-978			white	
7-979			black	



Fernbedienung

Modulbeispiel

Inklusive kostenlosem »Casambi App« Download:
Download the free »Casambi App«:



Puk Mini, Puk Maxx & Puk Meg Maxx

Kopf-Konfigurationen Head configuration

We are family. Lernen Sie alle Mitglieder der Puk-Familie kennen. Become acquainted with all the members of the Puk family.



Puk Kopf-Konfiguration (frei wählbar)

Puk Configuration (freely selectable)

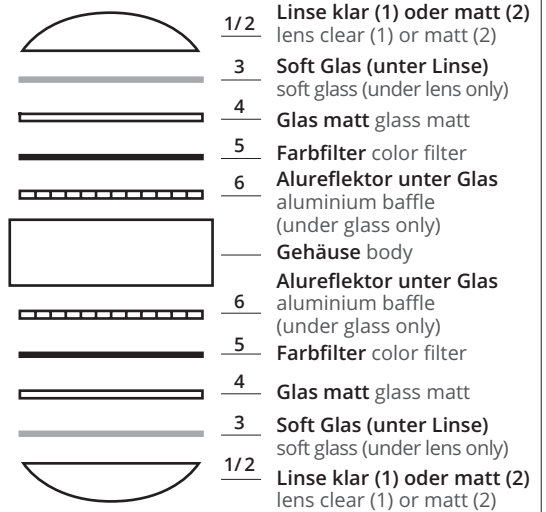

Puk Mini Wall LED: Kopf-Konfigurationen Head configuration

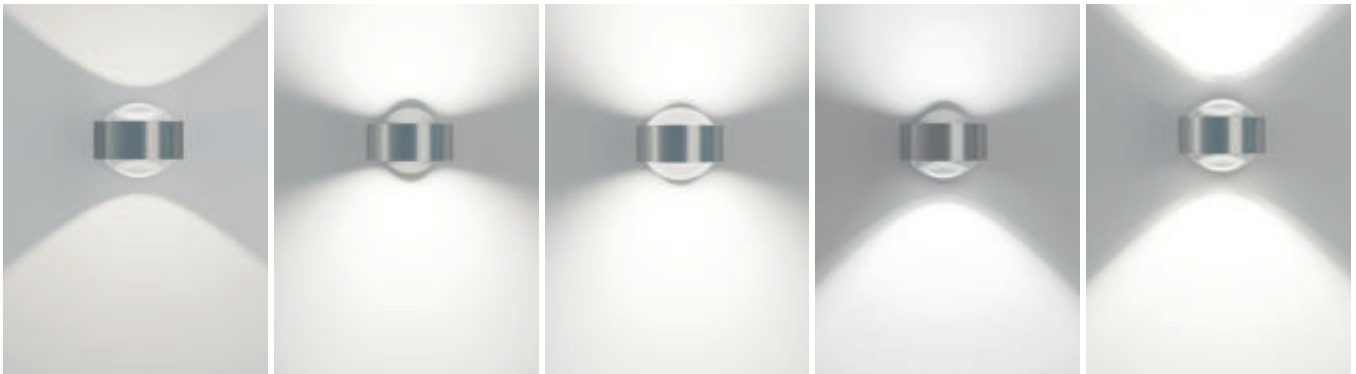

2 x Soft Glas, Linse klar
2 x soft glass, lens clear

Glas matt/Glas matt
glass matt/glass matt

Linse matt/Linse matt
lens matt/lens matt

Glas matt/Linse klar
glass matt/lens clear

Linse klar/Linse klar
lens clear/lens clear

Puk Maxx Wall LED: Farbfilter Color Filter

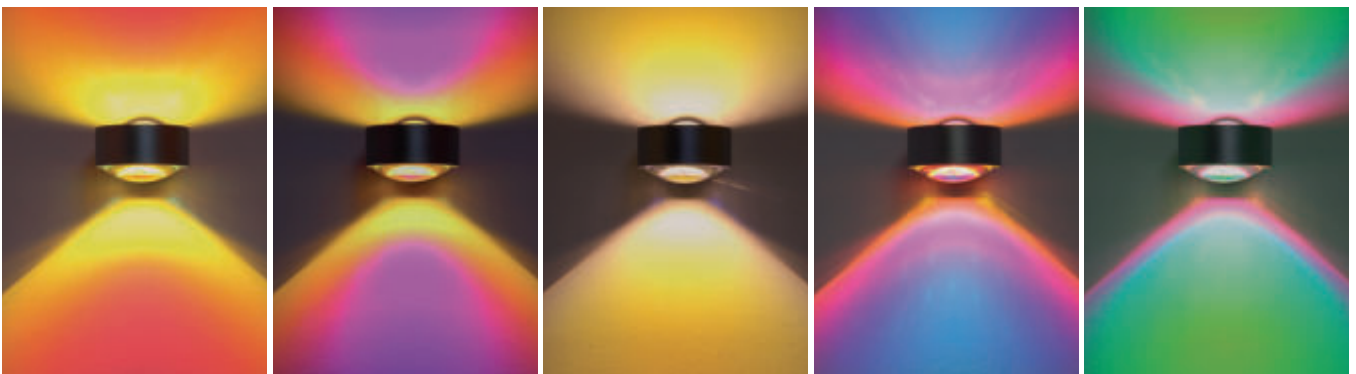

Farbfilter rot
color filter red

Farbfilter magenta
color filter magenta

Farbfilter gelb
color filter yellow

Farbfilter blau
color filter blue

Farbfilter grün
color filter green

Puk Mini, Puk Maxx & Puk Meg Maxx

Diese intelligente und moderne Leuchtenserie bietet Wand-, Decken-, Spiegel-, Pendel-, Steh- und Tischleuchten in verschiedenen Oberflächen. Auf dieser Seite sehen Sie die Möglichkeiten der Bestückung mit Linse, Glas, Lichtstopp und Farbfilter – egal ob Halogen oder LED.

This smart and modern lighting range offers wall, ceiling, mirror, pendula, floor and table lamps with various surfaces. On this page we show the possibilities of equipment with lens, glass, lightstop and color filter - no matter whether halogen or LED.



Puk Meg Maxx
ø 160 mm



Puk Mini Plus
ø 80 mm



Puk Maxx Plus
ø 120 mm

Puk Mini Wall: Oberflächen Surfaces

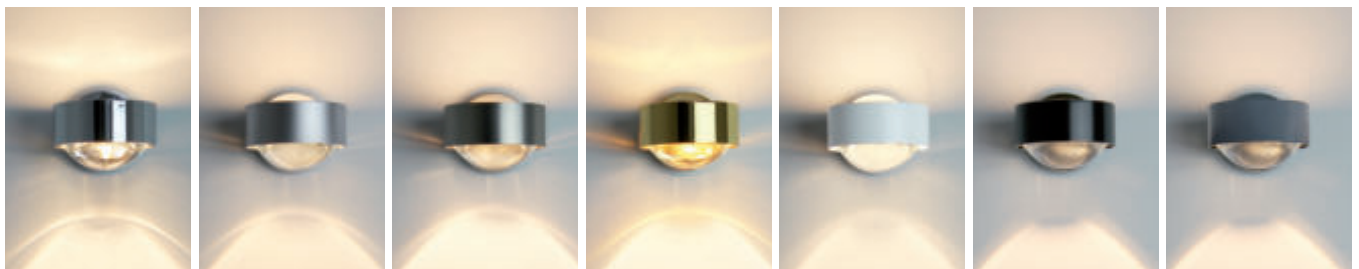

chrom
chrome

chrom matt
chrome matt

nickel matt
nickel matt

gold
gold

weiß matt
white matt

schwarz matt
black matt

anthrazit matt
anthracite matt



OVERVIEW LIGHT FOR LIVING *... and Office!*

INDOOR	12 - 289
1. Deckenleuchten/Einbauleuchten	14 - 107/108 - 111
2. Wandleuchten	112 - 175
3. Steckerleuchten	176 - 183
4. Pendelleuchten	184 - 237
5. Stehleuchten	238 - 265
6. Tischleuchten	266 - 289

SYSTEM	290 - 347
1. Mini Track	292 - 307
2. Top Line: Ceiling , Gallery, Crown	308 - 341
3. Eutrac	342 - 347

BATH & WELLNESS	348 - 419
1. Spiegelleuchten	352 - 375
2. Design LED-Lichtspiegel	376 - 419

OUTDOOR	420 - 464
1. Deckenleuchten	424 - 439
2. Wandleuchten	440 - 445
3. Pollerleuchten	446 - 449
4. Schirmleuchten	450 - 453
5. Bodeneinbauleuchten	454 - 464

SPEZIALS	465 - 493
-----------------	------------------

INDOOR

1. Deckenleuchten	14 - 107
Einbauleuchten	108 - 111
2. Wandleuchten	112 - 175
3. Steckerleuchten	176 - 183
4. Pendelleuchten	184 - 237
5. Stehleuchten	238 - 265
6. Tischleuchten	266 - 289

Leuchten geben einem Neubau oder renovierten Immobilien erst den letzten Schliff. Sie vervollkommen das stilistische Bild der Architektur. Deshalb finden sich in unserem Programm Designerlampen, die diesem Anspruch genügen und jede Architektur stilvoll abrunden. Die energiesparende LED Technologie steht immer mehr im Focus. Auf Wunsch finden Sie aber auch viele Modelle mit Halogenfassung in unserem Programm.

Luminaires add the finishing touch to a new build or renovated property. They enhance the stylistic image of the architecture. That is why our range includes designer lamps that meet this requirement and stylishly round off any architecture. The focus is increasingly on energy-saving LED technology. On request, however, you will also find many models with halogen sockets in our range.

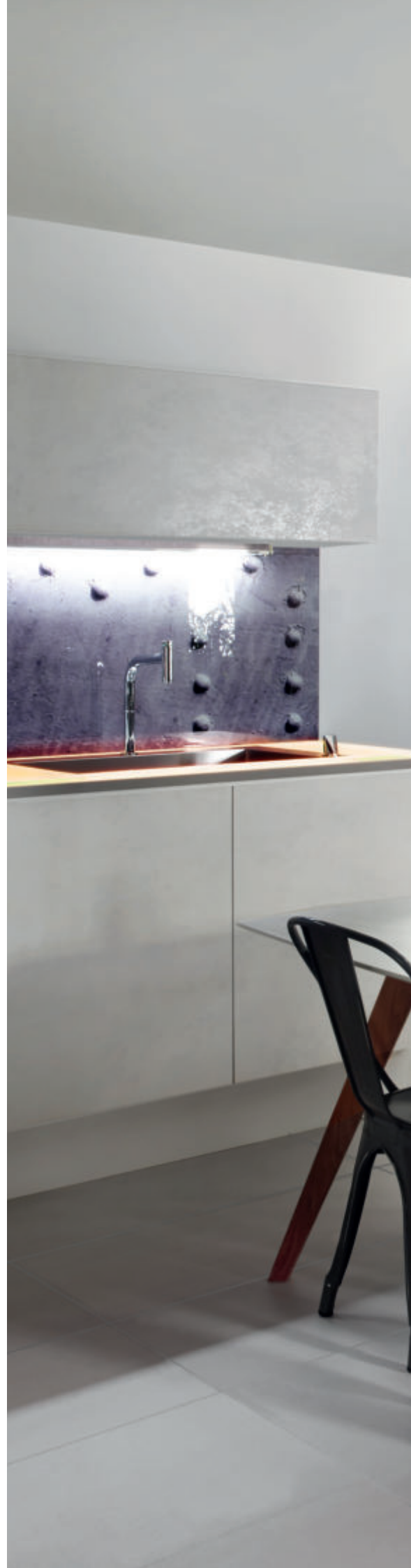





DECKENLEUCHTEN

CEILING LAMPS



Puk Mini One 17



Puk Mini One 2 19
Puk Maxx One 2 21



Puk Mini Plus 23
Puk Maxx Plus 25
Puk Meg Maxx Plus 27



Puk Mini Turn 29
Puk Maxx Turn 31



Puk Mini Move 33
Puk Maxx Move 35



Puk Mini Eye Ceiling 37
Puk Maxx Eye Ceiling 39
Puk Meg Maxx Eye Ceiling 41



Puk Mini Side Single 43
Puk Maxx Side Single 45



Puk Mini Side Twin 47
Puk Maxx Side Twin 49

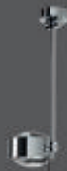

Puk Mini Wing Single 51
Puk Maxx Wing Single 53



Puk Mini Wing Twin 55
Puk Maxx Wing Twin 57



Puk Maxx Next 59
Puk Meg Maxx Next 61



Puk Mini Ceiling Sister 63
Puk Maxx Ceiling Sister 65



Puk Mini Move Choice 67
Puk Maxx Move Choice 69



Puk Mini Turn Choice 71
Puk Maxx Turn Choice 73



Puk Mini Eye Choice 75
Puk Maxx Eye Choice 77



Puk Mini Side Choice 79
Puk Maxx Side Choice 81

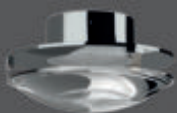

Paxx 83



Allround 85



Allround Flat 87



Foxx Round 89



Foxx Cube 91



Sun Ceiling 93



Sun Ceiling Choice downlight 95
Sun Ceiling Choice uplight 97



Only Choice 99



Dela 101



Dela Box 103



Quadro 105



Quadro Box 107



Puk Mini Inside 109
Puk Maxx Inside 111





Puk Mini One Ø 80

Deckenleuchte, Hochvolt Halogen oder LED Power, dimmbar.
Ceiling lamp, high voltage halogen or LED power, dimmable.

INDOOR

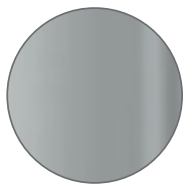

chrome matt

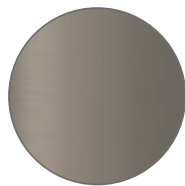

nickel matt

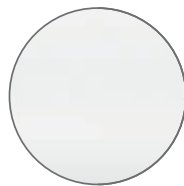

white matt

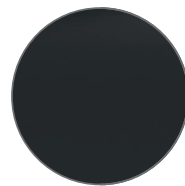

black matt

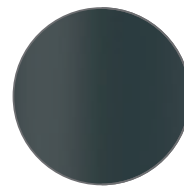

anthracite matt

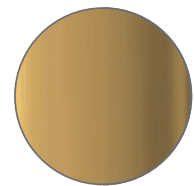

24c gold

Puk Mini One LED 8W ~600lm ~2.700k	Puk Mini One G9 Fassung	Ø x Höhe Ø x height in mm	Gehäuse body
2-08001-LED	2-08001	80 x 33	chrome matt
2-08002-LED	2-08002	80 x 33	chrome
2-08003-LED	2-08003	80 x 33	nickel matt
2-08002-LED-22	2-08002-22	80 x 33	white matt
2-08002-LED-02	2-08002-02	80 x 33	black matt
2-08002-LED-23	2-08002-23	80 x 33	anthracite matt
2-08006	2-08006	80 x 33	24 c. gold plated

▶ Ohne Zubehör. Bestell-Artikelnummern für Linse, Glas, Farbfilter und die Konfigurationsempfehlung (2) auf der Einklappseite!

▶ Without accessories: Order item-no. for lens, glass, color filter and the recommended Configuration (2) are on the fold-in page!

G9 max. 33W ECO, optional LED Retrofit
 G9 max. 33W ECO, LED Retrofit optional

Leuchtmittelempfehlung: LED max. 3W/300lm/2.700K/dimmbar Art Nr. 8-205
 bulb recommendation: LED max. 3W/300Lm/2.700K/dimmable Item No. 8-205

Chrom Teile/
chrome parts
 Gepulverte Teile/
powder-coating

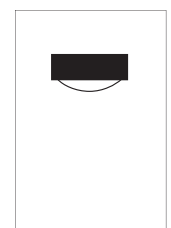
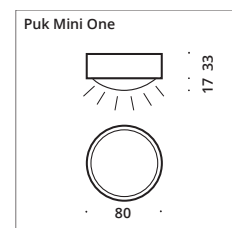





Puk Mini One 2 ø 80

Deckenleuchte, Hochvolt Halogen oder LED Power, dimmbar.
Ceiling lamp, high voltage halogen or LED power, dimmable.

INDOOR

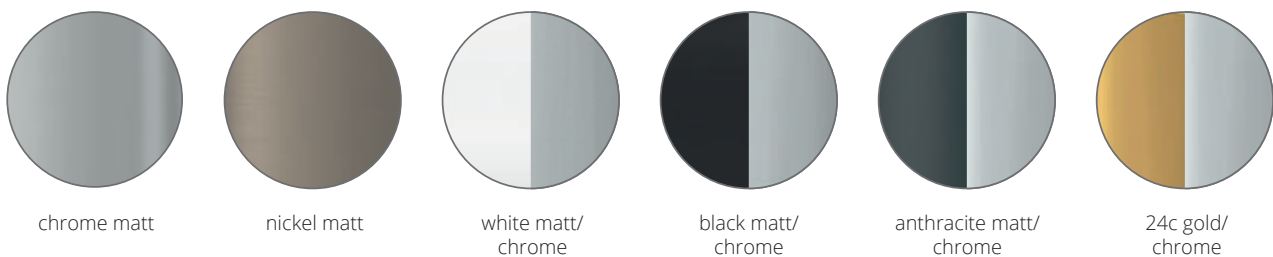

Puk Mini One 2 LED G 8W ~600lm ~2.700k	Puk Mini One 2 G9 Fassung	ø x Höhe ø x height in mm	Gehäuse body
2-080021-LED	2-080021	80 x 40	chrome matt
2-080022-LED	2-080022	80 x 40	chrome
2-080023-LED	2-080023	80 x 40	nickel matt
2-080022-LED-22	2-080022-22	80 x 40	white matt/chrome
2-080022-LED-02	2-080022-02	80 x 40	black matt/chrome
2-080022-LED-23	2-080022-23	80 x 40	anthracite matt/chr.
2-080026	2-080026	80 x 40	24 c. gold plated/chr.

► Ohne Zubehör. Bestell-Artikelnummern für Linse, Glas, Farbfilter und die Konfigurationsempfehlung (2) auf der Einklappseite!

► Without accessories: Order item-no. for lens, glass, color filter and the recommended Configuration (2) are on the fold-in page!

G9 max. 33W ECO, optional LED Retrofit
 G9 max. 33W ECO, LED Retrofit optional

Leuchtmittelempfehlung: LED max. 3W/300lm/2.700K/dimmbar **G** Art. Nr. 8-205
 bulb recommendation: LED max. 3W/300Lm/2.700K/dimmable **G** Item No. 8-205

Chrom Teile/
chrome parts
 Gepulverte Teile/
powder-coating

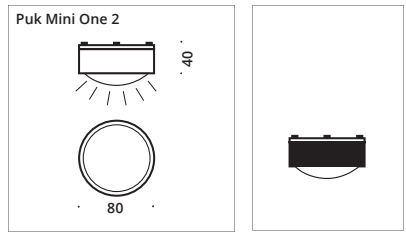





Puk Maxx One 2 \varnothing 120

Deckenleuchte, Hochvolt Halogen oder LED Power, dimmbar.
Ceiling lamp, high voltage halogen or LED power, dimmable.

INDOOR



chrome

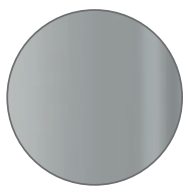

chrome matt

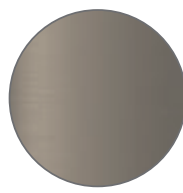

nickel matt

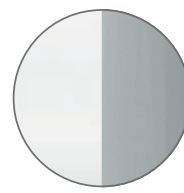

white matt/
chrome

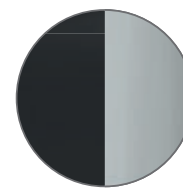

black matt/
chrome

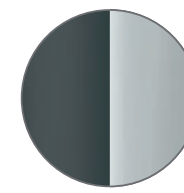

anthracite matt/
chrome

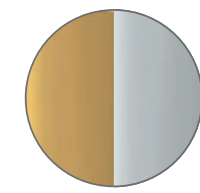

24c gold/
chrome

Puk Maxx One 2 LED G 1 x 12W ~900lm ~2.700k	Puk Maxx One 2 G9 Fassung	\varnothing x Höhe \varnothing x height in mm	Gehäuse body
2-3008001	2-3008001-H	120 x 57,5	chrome matt
2-3008002	2-3008002-H	120 x 57,5	chrome
2-3008003	2-3008003-H	120 x 57,5	nickel matt
2-3008002-22	2-3008002-H-22	120 x 57,5	white matt/chrome
2-3008002-02	2-3008002-H-02	120 x 57,5	black matt/chrome
2-3008002-23	2-3008002-H-23	120 x 57,5	anthracite matt/chr.
2-3008006	2-3008006-H	120 x 57,5	24 ct gold plated/chr.

► Ohne Zubehör. Bestell-Artikelnummern für Linse, Glas, Farbfilter und die Konfigurationsempfehlung (2) auf der Einklappseite!

► Without accessories: Order item-no. for lens, glass, color filter and the recommended Configuration (2) are on the fold-in page!

G9 max. 33W ECO, optional LED Retrofit

G9 max. 33W ECO, LED Retrofit optional

Leuchtmittelempfehlung: LED max. 3W/300lm/2.700K/dimmbar **G** Art. Nr. 8-205
bulb recommendation: LED max. 3W/300Lm/2.700K/dimmable **G** Item No. 8-205

Chrom Teile/
chrome parts
 Gepulverte Teile/
powder-coating

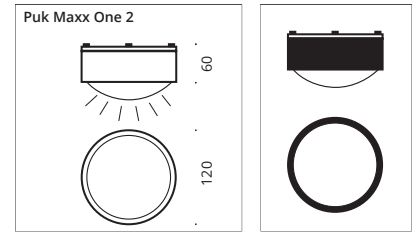





Puk Mini Plus \varnothing 80

Deckenleuchte, Hochvolt Halogen oder LED Power, dimmbar.
Ceiling lamp, high voltage halogen or LED power, dimmable.

INDOOR



chrome

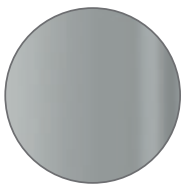

chrome matt

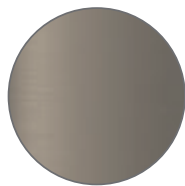

nickel matt

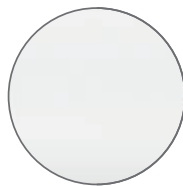

white matt

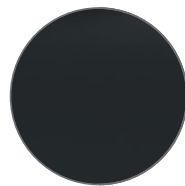

black matt

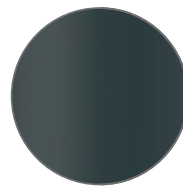

anthracite matt

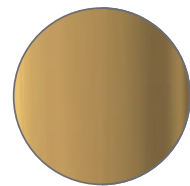

24c gold

Puk Mini Plus LED G 8W ~600lm ~2.700k	Puk Mini Plus G9 Fassung	\varnothing x Höhe \varnothing x height	Gehäuse body
2-18001-LED	2-18001	80 x 53 mm	chrome matt
2-18002-LED	2-18002	80 x 53 mm	chrome
2-18003-LED	2-18003	80 x 53 mm	nickel matt
2-18002-LED-22	2-18002-22	80 x 53 mm	white matt
2-18002-LED-02	2-18002-02	80 x 53 mm	black matt
2-18002-LED-23	2-18002-23	80 x 53 mm	anthracite matt
2-18006-LED	2-18006	80 x 53 mm	24 carat gold plated

► Ohne Zubehör. Bestell-Artikelnummern für Linse, Glas, Farbfilter und die Konfigurationsempfehlung (2) auf der Einklappseite!

► Without accessories: Order item-no. for lens, glass, color filter and the recommended Configuration (2) are on the fold-in page!

G9 max. 33W ECO, optional LED Retrofit

G9 max. 33W ECO, LED Retrofit optional

Leuchtmittelempfehlung: LED max. 3W/300lm/2.700K/dimmbar **G** Art. Nr. 8-205
 bulb recommendation: LED max. 3W/300Lm/2.700K/dimmable **G** Item No. 8-205

Chrom Teile/
chrome parts
 Gepulverte Teile/
powder-coating

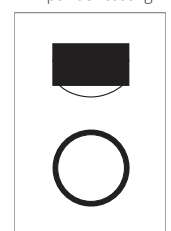
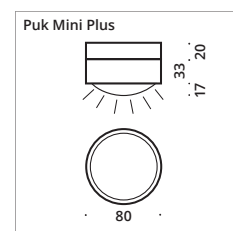





Puk Maxx Plus \varnothing 120

Deckenleuchte, Hochvolt Halogen oder LED Power, dimmbar.
Ceiling lamp, high voltage halogen or LED power, dimmable.

INDOOR



chrome

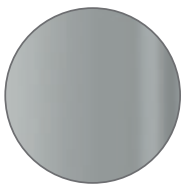

chrome matt

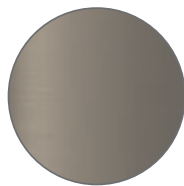

nickel matt

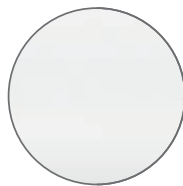

white matt

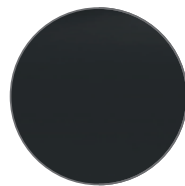

black matt

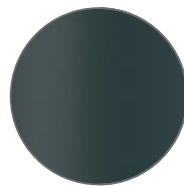

anthracite matt

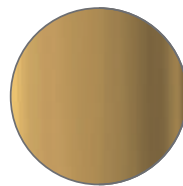

24c gold

Puk Maxx Plus LED G 12W ~900lm ~2.700k	Puk Maxx Plus G9 Fassung	\varnothing x Höhe \varnothing x height	Gehäuse body
2-3018001	2-3018001-H	120 x 91 mm	chrome matt
2-3018002	2-3018002-H	120 x 91 mm	chrome
2-3018003	2-3018003-H	120 x 91 mm	nickel matt
2-3018002-22	2-3018002-H-22	120 x 91 mm	white matt
2-3018002-02	2-3018002-H-02	120 x 91 mm	black matt
2-3018002-23	2-3018002-H-23	120 x 91 mm	anthracite matt
2-3018006	2-3018006-H	120 x 91 mm	24 ct gold plated

► Ohne Zubehör. Bestell-Artikelnummern für Linse, Glas, Farbfilter und die Konfigurationsempfehlung (2) auf der Einklappseite!

► Without accessories: Order item-no. for lens, glass, color filter and the recommended Configuration (2) are on the fold-in page!

G9 max. 33W ECO, optional LED Retrofit
 G9 max. 33W ECO, LED Retrofit optional

Leuchtmittelpfehlung: LED max. 3W/300lm/2.700K/dimmbar **G** Art. Nr. 8-205
 bulb recommendation: LED max. 3W/300Lm/2.700K/dimmable **G** Item No. 8-205

Chrom Teile/
chrome parts
 Gepulverte Teile/
powder-coating

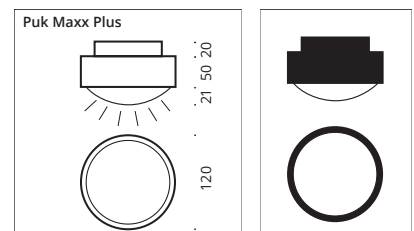

ABC (s.S 6-7/s.p. 6-7)





Puk Meg Maxx Plus ø 160

Deckenleuchte, Hochvolt LED Power oder Hochvolt Halogen, dimmbar.

Ceiling lamp, high voltage LED power or high voltage halogen, dimmable.

INDOOR



chrome

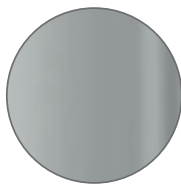

chrome matt

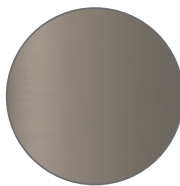

nickel matt

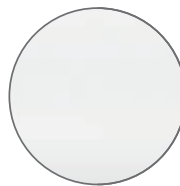

white matt

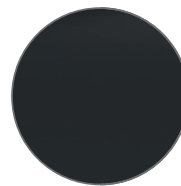

black matt

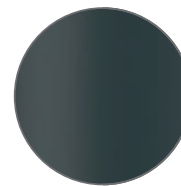

anthracite matt

Puk Meg Maxx Plus LED G 1 x 18W ~1.500lm, ~2.700k	Puk Meg Maxx Plus G9 Fassung	ø x Höhe ø x height in mm	Gehäuse body
● 2-402801	2-402801-H	160 x 80	chrome matt
● 2-402802	2-402802-H	160 x 80	chrome
● 2-402803	2-402803-H	160 x 80	nickel matt
● 2-402802-22	2-402802-H-22	160 x 80	white matt
● 2-402802-02	2-402802-H-02	160 x 80	black matt
● 2-402802-23	2-402802-H-23	160 x 80	anthracite matt

▶ Ohne Zubehör. Bestell-Artikelnummern für Linse, Glas, Farbfilter und die Konfigurationsempfehlung (2) auf der Einklappseite!



▶ Without accessories: Order item-no. for lens, glass, color filter and the recommended Configuration (2) are on the fold-in page!

💡 G9 max. 33W ECO, optional LED Retrofit
💡 G9 max. 33W ECO, LED Retrofit optional

💡 Leuchtmittelempfehlung: LED max. 3W/300lm/2.700K/dimmbar **G** Art. Nr. 8-205
💡 bulb recommendation: LED max. 3W/300Lm/2.700K/dimmable **G** Item No. 8-205

☐ Chrom Teile/
chrome parts
■ Gepulverte Teile/
powder-coating

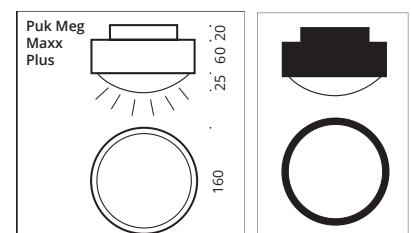





Puk Mini Turn \varnothing 80

Deckenleuchte, Hochvolt Halogen oder LED Power, dimmbar. Kopf dreh- und schwenkbar.

Ceiling lamp, high voltage halogen or LED power, dimmable. Head rotatable and titable.

INDOOR



Puk Mini Turn LED G ~1.200lm ~2.700k	Puk Mini Turn G9 Fassung !	\varnothing x Höhe \varnothing x height in mm	Gehäuse body
up- & downlight 2 x 8W			
● 2-28001-LED	2-28001	80 x 120	chrome matt
● 2-28002-LED	2-28002	80 x 120	chrome
● 2-28003-LED	2-28003	80 x 120	nickel matt
● 2-28002-LED-22	2-28002-22	80 x 120	white matt/chrome
● 2-28002-LED-02	2-28002-02	80 x 120	black matt/chrome
● 2-28002-LED-23	2-28002-23	80 x 120	anthracite matt/chrome
● 2-28006-LED	2-28006	80 x 120	24 carat gold plated/chrome
downlight 1 x 8W			
○ 2-38001-LED	2-38001	80 x 120	chrome matt
○ 2-38002-LED	2-38002	80 x 120	chrome
○ 2-38003-LED	2-38003	80 x 120	nickel matt
○ 2-38002-LED-22	2-38002-22	80 x 120	white matt/chrome
○ 2-38002-LED-02	2-38002-02	80 x 120	black matt/chrome
○ 2-38002-LED-23	2-38002-23	80 x 120	anthracite matt/chrome
○ 2-38006-LED	2-38006	80 x 120	24 carat gold plated/chrome

► Ohne Zubehör. Bestell-Artikelnummern für Linse, Glas, Farbfilter und die Konfigurationsempfehlung (2) auf der Einklappseite!

► Without accessories: Order item-no. for lens, glass, color filter and the recommended Configuration (2) are on the fold-in page!

! G9 max. 33W ECO, optional LED Retrofit

! G9 max. 33W ECO, LED Retrofit optional

! Leuchtmittelempfehlung: LED max. 3W/300lm/2.700K/dimmbar **G** Art. Nr. 8-205
! bulb recommendation: LED max. 3W/300Lm/2.700K/dimmable **G** Item No. 8-205



Chrom Teile/
chrome parts
 Gepulverte Teile/
powder-coating

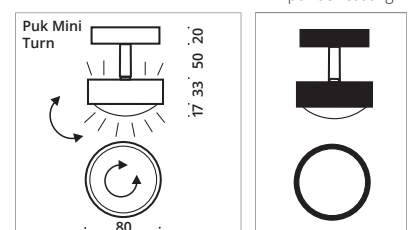





Puk Maxx Turn ø 120

Deckenleuchte, Hochvolt Halogen oder LED Power, dimmbar, Kopf dreh- und schwenkbar.

Ceiling lamp, high voltage halogen or LED power, dimmable, head rotatable and titable.

INDOOR



chrome matt

nickel matt

white matt/
chrome

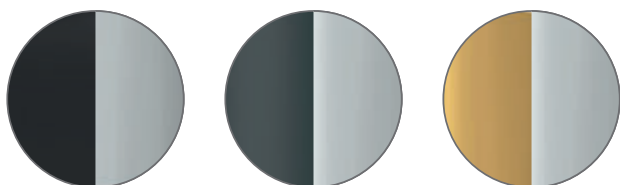

black matt/
chrome

anthracite matt/
chrome

24c gold/
chrome



chrome

Puk Maxx Turn LED downlight	Puk Maxx Turn LED up-/downlight	Puk Maxx Turn G9 Fassung downlight	Puk Maxx Turn G9 Fassung up-/downlight	ø x Höhe mm ø x height mm	Gehäuse body
G 1 x 12W ~900lm ~2.700k	G 2 x 12W ~1.800lm ~2.700k				
● 2-3028001	2-3038001	2-3028001-H	2-3038001-H	120 x 141	chrome matt
● 2-3028002	2-3038002	2-3028002-H	2-3038002-H	120 x 141	chrome
● 2-3028003	2-3038003	2-3028003-H	2-3038003-H	120 x 141	nickel matt
● 2-3028002-22	2-3038002-22	2-3028002-H-22	2-3038002-H-22	120 x 141	white matt/chrome
● 2-3028002-02	2-3038002-02	2-3028002-H-02	2-3038002-H-02	120 x 141	black matt/chrome
● 2-3028002-23	2-3038002-23	2-3028002-H-23	2-3038002-H-23	120 x 141	anthracite matt/chr.
● 2-3028006	2-3038006	2-3028006-H	2-3038006-H	120 x 141	24 ct gold plated/chr.

Chrom Teile/
chrome parts
 Gepulverte Teile/
powder-coating

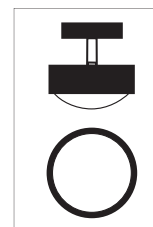

► Ohne Zubehör. Bestell-Artikelnummern für Linse, Glas, Farbfilter und die Konfigurationsempfehlung (2) auf der Einklappseite!



► Without accessories: Order item-no. for lens, glass, color filter and the recommended Configuration (2) are on the fold-in page!

G9 max. 33W ECO, optional LED Retrofit
 G9 max. 33W ECO, LED Retrofit optional

Leuchtmittelempfehlung: LED max. 3W/300lm/2.700K/dimmbar **G** Art. Nr. 8-205
 bulb recommendation: LED max. 3W/300Lm/2.700K/dimmable **G** Item No. 8-205

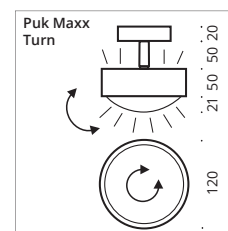





Puk Mini Move \varnothing 80

Deckenleuchte, Hochvolt LED Power oder Hochvolt Halogen, dimmbar. Dreh- (360°) und schwenkbare (\approx 50°) Deckenleuchte.

Ceiling lamp, high voltage LED power or high voltage halogen, dimmable. Rotating (360°) and titable (\approx 50°) ceiling lamp.

INDOOR

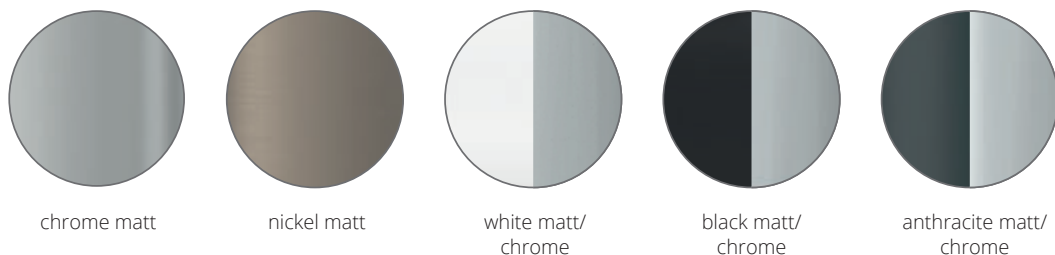
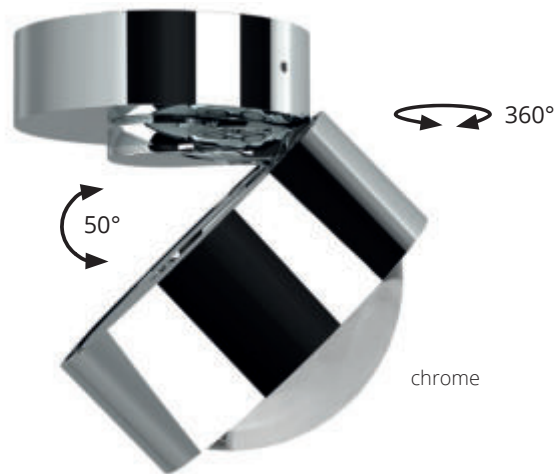

Puk Mini Move LED G 8W, ~600lm ~2.700k	Puk Mini Move G9 Fassung	\varnothing x Höhe \varnothing x height in mm	Gehäuse body
7-69001	7-69001-H	80 x 53	chrome matt
7-69002	7-69002-H	80 x 53	chrome
7-69003	7-69003-H	80 x 53	nickel matt
7-69002-22	7-69002-H-22	80 x 53	white matt/chrome
7-69002-02	7-69002-H-02	80 x 53	black matt/chrome
7-69002-23	7-69002-H-23	80 x 53	anthracite matt/chrome

- ▶ Ohne Zubehör. Bestell-Artikelnummern für Linse, Glas, Farbfilter und die Konfigurationsempfehlung (2) auf der Einklappseite!
- ▶ Without accessories: Order item-no. for lens, glass, color filter and the recommended Configuration (2) are on the fold-in page!

G9 max. 3W LED Retrofit
 G9 max. 3W Retrofit optional

Leuchtmittelempfehlung: LED max. 3W/300lm/2.700K/dimmbar **G** Art. Nr. 8-205
 bulb recommendation: LED max. 3W/300Lm/2.700K/dimmable **G** Item No. 8-205



Chrom Teile/
chrome parts
 Gepulverte Teile/
powder-coating

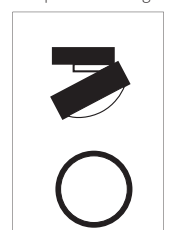
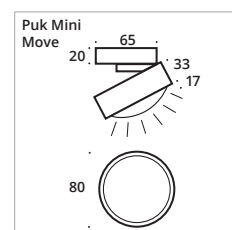





Puk Maxx Move ø 120

Deckenleuchte, Hochvolt LED Power oder Hochvolt Halogen, dimmbar. Dreh- (360°) und schwenkbare (± 106°) Deckenleuchte.

Ceiling lamp, high voltage LED power or high voltage halogen, dimmable. Rotating (360°) and titable (±106°) ceiling lamp.

INDOOR

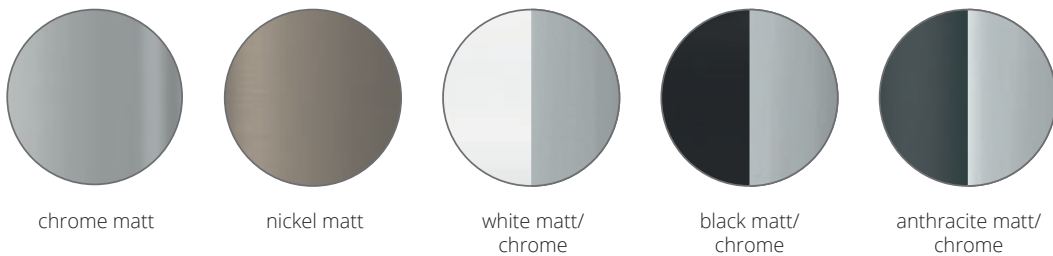

Puk Maxx Move LED G 12W, ~900lm ~2.700k	Puk Maxx Move G9 Fassung	ø x Höhe ø x height in mm	Gehäuse body
● 7-69301	7-69301-H	120 x 70	chrome matt
● 7-69302	7-69302-H	120 x 70	chrome
● 7-69303	7-69303-H	120 x 70	nickel matt
● 7-69302-22	7-69302-H-22	120 x 70	white matt/chrome
● 7-69302-02	7-69302-H-02	120 x 70	black matt/chrome
● 7-69302-23	7-69302-H-23	120 x 70	anthracite matt/chrome

▶ Ohne Zubehör. Bestell-Artikelnummern für Linse, Glas, Farbfilter und die Konfigurationsempfehlung (2) auf der Einklappseite!



▶ Without accessories: Order item-no. for lens, glass, color filter and the recommended Configuration (2) are on the fold-in page!

G9 max. 5W LED Retrofit
 G9 max. 5W Retrofit optional

Leuchtmittelempfehlung: LED max. 3W/300lm/2.700K/dimmbar **G** Art. Nr. 8-205
 bulb recommendation: LED max. 3W/300Lm/2.700K/dimmable **G** Item No. 8-205



Chrom Teile/
chrome parts
 Gepulverte Teile/
powder-coating

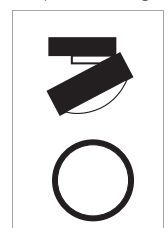
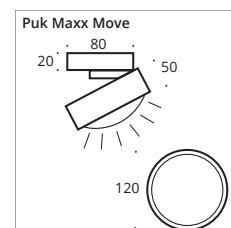





Puk Mini Eye Ceiling \varnothing 80 up & downlight

Deckenleuchte, Hochvolt LED Power oder Hochvolt Halogen, dimmbar. Smarte Deckenleuchte mit fest installierter Linse »up« und optionaler Linse oder Glas »down«.

Ceiling lamp, high voltage LED power or high voltage halogen, dimmable. Smart ceiling lamp with permanently installed "up" lens and optional "down" lens or glass.

INDOOR

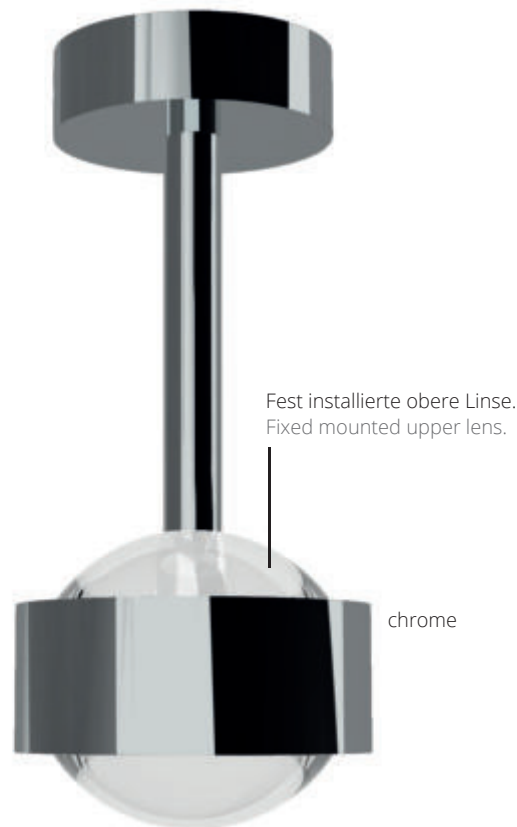
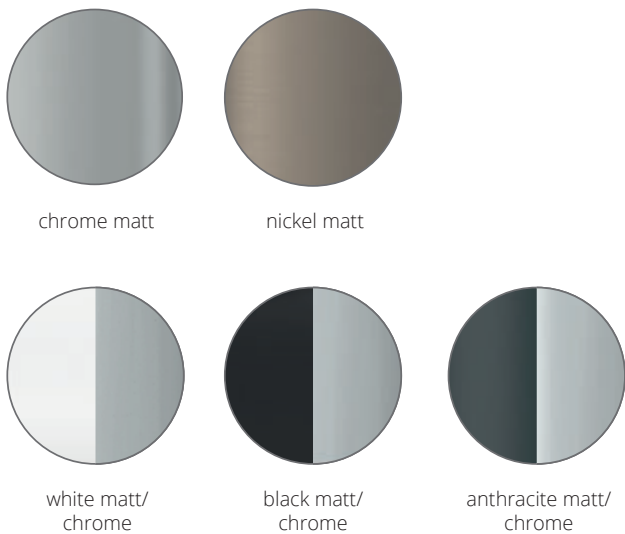

Fest installierte obere Linse.
Fixed mounted upper lens.

chrome

Puk Eye Ceiling LED G 2 x 8W, ~600lm ~2.700k	Puk Eye Ceiling G9 Fassung	\varnothing x Höhe \varnothing x height in mm	Gehäuse body
7-75001	7-75001-H	80 x 170	chrome matt
7-75002	7-75002-H	80 x 170	chrome
7-75003	7-75003-H	80 x 170	nickel matt
7-75002-22	7-75002-H-22	80 x 170	white matt/chr.
7-75002-02	7-75002-H-02	80 x 170	black matt/chr.
7-75002-23	7-75002-H-23	80 x 170	anthracite matt/chr.

► Ohne Zubehör. Bestell-Artikelnummern für Linse, Glas, Farbfilter und die Konfigurationsempfehlung (2) auf der Einklappseite!

► Without accessories: Order item-no. for lens, glass, color filter and the recommended Configuration (2) are on the fold-in page!

G9 max. 33W ECO, optional LED Retrofit
 G9 max. 33W ECO, LED Retrofit optional

Leuchtmittelempfehlung: LED max. 3W/300lm/2.700K/dimmbar **G** Art. Nr. 8-205
 bulb recommendation: LED max. 3W/300Lm/2.700K/dimmable **G** Item No. 8-205

Chrom Teile/
chrome parts
 Gepulverte Teile/
powder-coating

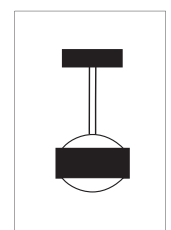
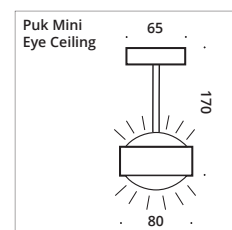





Puk Maxx Eye Ceiling \varnothing 120 up & downlight

Deckenleuchte, Hochvolt LED Power oder Hochvolt Halogen, dimmbar. Smarte Deckenleuchte mit fest installierter Linse »up« und optionaler Linse oder Glas »down«.

Ceiling lamp, high voltage LED power or high voltage halogen, dimmable. Smart ceiling lamp with permanently installed "up" lens and optional "down" lens or glass.

INDOOR

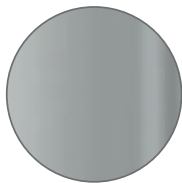

chrome matt



nickel matt

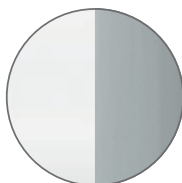

white matt/
chrome

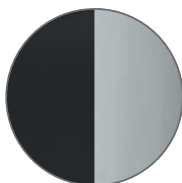

black matt/
chrome

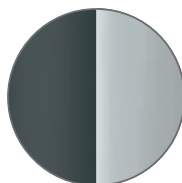

anthracite matt/
chrome

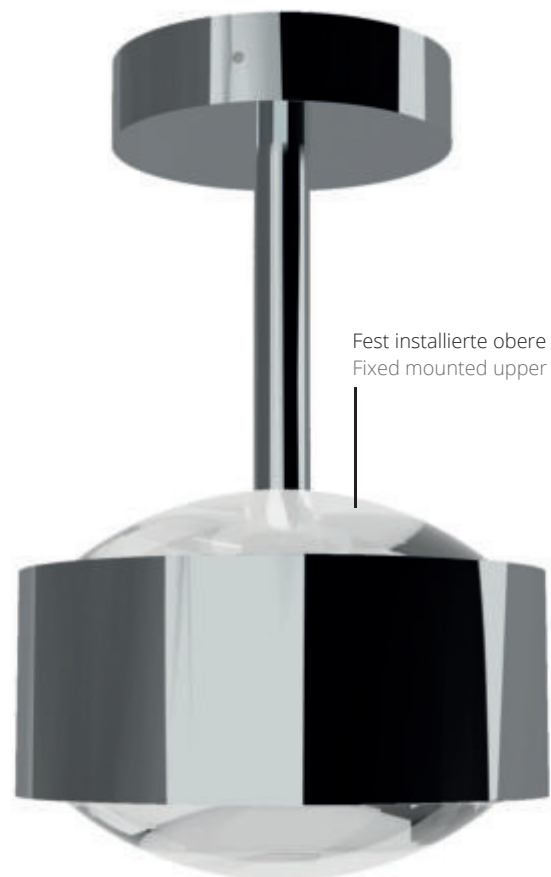

chrome

Fest installierte obere Linse.
Fixed mounted upper lens.

Puk Maxx Eye Ceiling LED G 2 x 12W, ~1.800lm ~2.700k	Puk Maxx Eye Ceiling G9 Fassung	\varnothing x Höhe \varnothing x height in mm	Gehäuse body
7-753001	7-753001-H	120 x 185	chrome matt
7-753002	7-753002-H	120 x 185	chrome
7-753003	7-753003-H	120 x 185	nickel matt
7-753002-22	7-753002-H-22	120 x 185	white matt/chr.
7-753002-02	7-753002-H-02	120 x 185	black matt/chr.
7-753002-23	7-753002-H-23	120 x 185	anthracite matt/chr.

► Ohne Zubehör. Bestell-Artikelnummern für Linse, Glas, Farbfilter und die Konfigurationsempfehlung (2) auf der Einklappseite!

► Without accessories: Order item-no. for lens, glass, color filter and the recommended Configuration (2) are on the fold-in page!

G9 max. 33W ECO, optional LED Retrofit
 G9 max. 33W ECO, LED Retrofit optional

Leuchtmittelempfehlung: LED max. 3W/300lm/2.700K/dimmbar **G** Art. Nr. 8-205
 bulb recommendation: LED max. 3W/300Lm/2.700K/dimmable **G** Item No. 8-205



Chrom Teile/
chrome parts
 Gepulverte Teile/
powder-coating

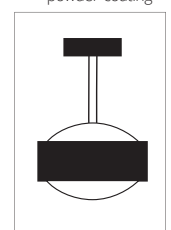
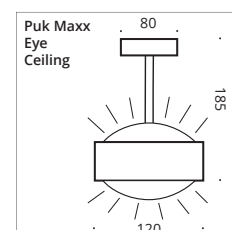





Puk Meg Maxx Eye Ceiling \varnothing 160 up & downlight

Deckenleuchte, Hochvolt LED Power oder Hochvolt Halogen, dimmbar. Smarte Deckenleuchte mit fest installierter Linse »up« und optionaler Linse oder Glas »down«.

Ceiling lamp, high voltage LED power or high voltage halogen, dimmable. Smart ceiling lamp with permanently installed "up" lens and optional "down" lens or glass.

INDOOR

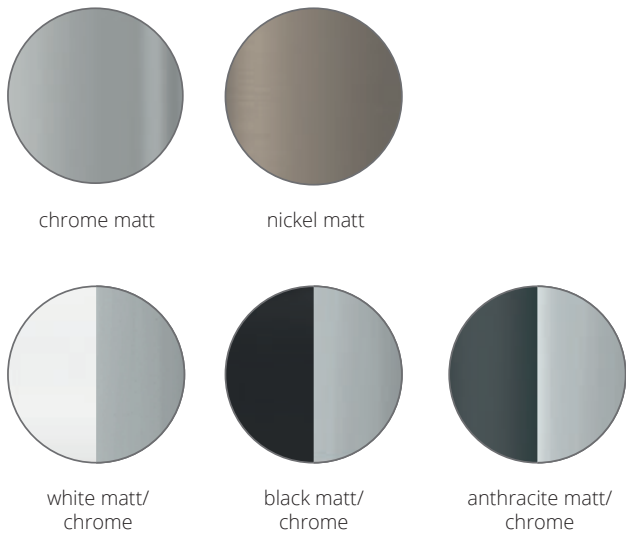

Puk Meg Maxx Eye Ceiling LED G 2 x 16W ~2.400lm ~2.700k	Puk Meg Maxx Eye Ceiling G9 Fassung	\varnothing x Höhe \varnothing x height in mm	Gehäuse body
7-755001	7-755001-H	160 x 210	chrome matt
7-755002	7-755002-H	160 x 210	chrome
7-755003	7-755003-H	160 x 210	nickel matt
7-755002-22	7-755002-H-22	160 x 210	white matt/chr.
7-755002-02	7-755002-H-02	160 x 210	black matt/chr.
7-755002-23	7-755002-H-23	160 x 210	anthracite matt/chr.

► Ohne Zubehör. Bestell-Artikelnummern für Linse, Glas, Farbfilter und die Konfigurationsempfehlung (2) auf der Einklappseite!

► Without accessories: Order item-no. for lens, glass, color filter and the recommended Configuration (2) are on the fold-in page!

G9 max. 33W ECO, optional LED Retrofit

G9 max. 33W ECO, LED Retrofit optional

Leuchtmittelempfehlung: LED max. 3W/300lm/2.700K/dimmbar **G** Art. Nr. 8-205

bulb recommendation: LED max. 3W/300Lm/2.700K/dimmable **G** Item No. 8-205



Chrom Teile/
chrome parts

Gepulverte Teile/
powder-coating

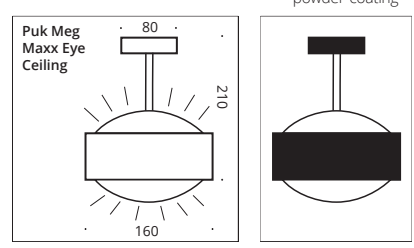

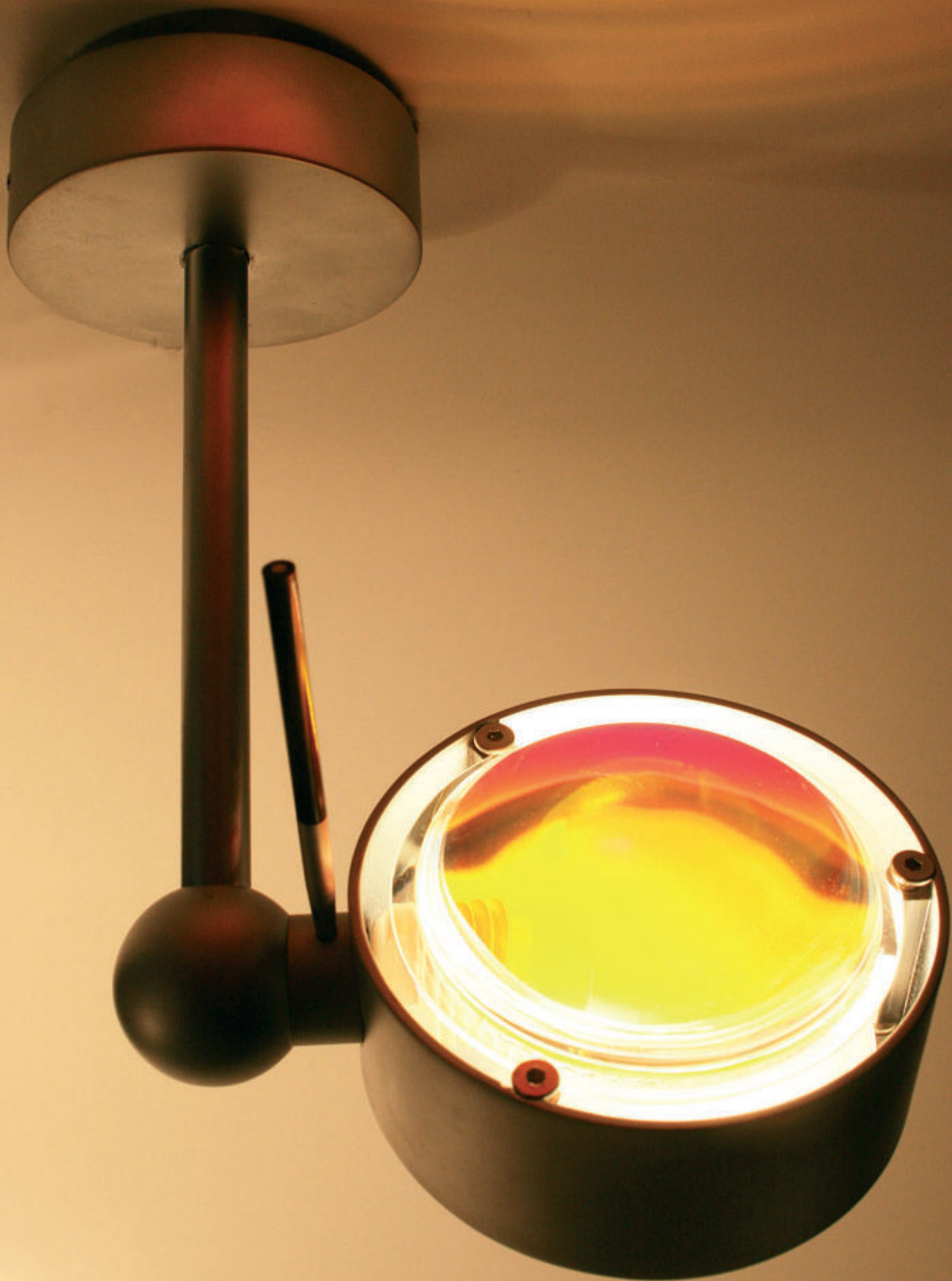

Puk Mini Side Single



Puk Mini Side Single ø 80

Deckenleuchte, Hochvolt Halogen oder LED Power, dimmbar, Kopf drehbar mit Verstellstift. Mit drehbarem Arm (bis 350°).

Ceiling lamp, high voltage halogen or LED power, dimmable, head rotatable with adjusting pin. With turnable arm (up to 350°).

INDOOR

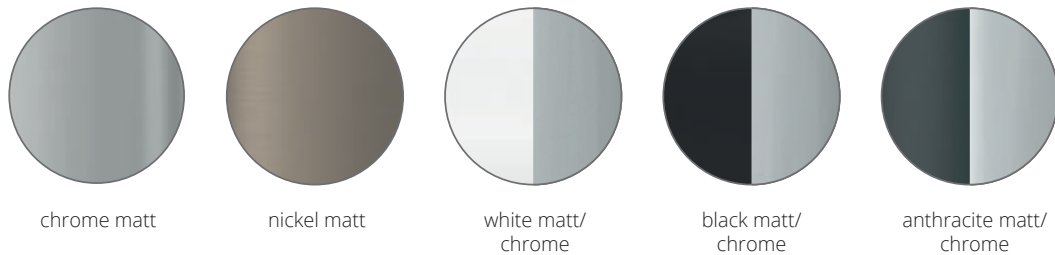

Puk Side Single LED G 2 x 8W ~1.200lm ~2.700k	Puk Side Single G9 Fassung L	Armlänge arm length in mm	Gehäuse body
● 2-0821-LED	2-0821	100	chrome matt
● 2-0822-LED	2-0822	100	chrome
● 2-0823-LED	2-0823	100	nickel matt
● 2-0822-LED-22	2-0822-22	100	white matt/chr.
● 2-0822-LED-02	2-0822-02	100	black matt/chr.
● 2-0822-LED-23	2-0822-23	100	anthracite matt/chr.
● 2-0831-LED	2-0831	200	chrome matt
● 2-0832-LED	2-0832	200	chrome
● 2-0833-LED	2-0833	200	nickel matt
● 2-0832-LED-22	2-0832-22	200	white matt/chr.
● 2-0832-LED-02	2-0832-02	200	black matt/chr.
● 2-0832-LED-23	2-0832-23	200	anthracite matt/chr.
● 2-0861-LED	2-0861	300	chrome matt
● 2-08062-LED	2-08062	300	chrome
● 2-0863-LED	2-0863	300	nickel matt
● 2-08062-LED-22	2-08062-22	300	white matt/chr.
● 2-08062-LED-02	2-08062-02	300	black matt/chr.
● 2-08062-LED-23	2-08062-23	300	anthracite matt/chr.
● 2-0871-LED	2-0871	400	chrome matt
● 2-0872-LED	2-0872	400	chrome
● 2-0873-LED	2-0873	400	nickel matt
● 2-0872-LED-22	2-0872-22	400	white matt/chr.
● 2-0872-LED-02	2-0872-02	400	black matt/chr.
● 2-0872-LED-23	2-0872-23	400	anthracite matt/chr.
● 2-0881-LED	2-0881	600	chrome matt
● 2-0882-LED	2-0882	600	chrome
● 2-0883-LED	2-0883	600	nickel matt
● 2-0882-LED-22	2-0882-22	600	white matt/chr.
● 2-0882-LED-02	2-0882-02	600	black matt/chr.
● 2-0882-LED-23	2-0882-23	600	anthracite matt/chr.



chrome

- ▶ Ohne Zubehör. Bestell-Artikelnummern für Linse, Glas, Farbfilter und die Konfigurationsempfehlung (2) auf der Einklappseite!
- ▶ Without accessories: Order item-no. for lens, glass, color filter and the recommended Configuration (2) are on the fold-in page!

G9 max. 33W ECO, optional LED Retrofit
 G9 max. 33W ECO, LED Retrofit optional

Leuchtmittelempfehlung: LED max. 3W/300lm/2.700K/dimmbar **G** Art. Nr. 8-205
 bulb recommendation: LED max. 3W/300Lm/2.700K/dimmable **G** Item No. 8-205

- Chrom Teile/
chrome parts
- Gepulverte Teile/
powder-coating

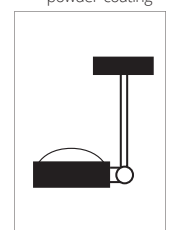
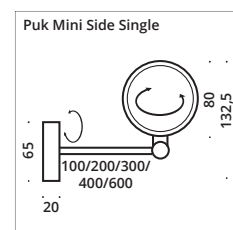



Puk Maxx Side Single



Puk Maxx Side Single \varnothing 120

Deckenleuchte mit Arm, Hochvolt Halogen oder LED Power, Kopf drehbar. Mit drehbarem Arm (bis 350°).

Ceiling lamp with arm, high voltage halogen or LED power, head rotatable. With turnable arm (up to 350°).

INDOOR

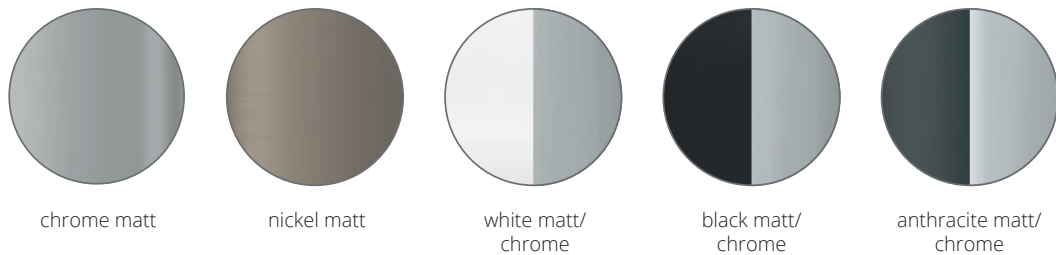

Puk Maxx Side Single LED 2 x 12W ~1.800lm ~2.700k	Puk Maxx Side Single G9 Fassung	Armlänge arm length in mm	Gehäuse body
2-30821	2-30821-H	100	chrome matt
2-30822	2-30822-H	100	chrome
2-30823	2-30823-H	100	nickel matt
2-30822-22	2-30822-H-22	100	white matt/chr.
2-30822-02	2-30822-H-02	100	black matt/chr.
2-30822-23	2-30822-H-23	100	anthracite matt/chr.
2-30831	2-30831-H	200	chrome matt
2-30832	2-30832-H	200	chrome
2-30833	2-30833-H	200	nickel matt
2-30832-22	2-30832-H-22	200	white matt/chr.
2-30832-02	2-30832-H-02	200	black matt/chr.
2-30832-23	2-30832-H-23	200	anthracite matt/chr.
2-30861	2-30861-H	300	chrome matt
2-30862	2-30862-H	300	chrome
2-30863	2-30863-H	300	nickel matt
2-30862-22	2-30862-H-22	300	white matt/chr.
2-30862-02	2-30862-H-02	300	black matt/chr.
2-30862-23	2-30862-H-23	300	anthracite matt/chr.
2-30871	2-30871-H	400	chrome matt
2-30872	2-30872-H	400	chrome
2-30873	2-30873-H	400	nickel matt
2-30872-22	2-30872-H-22	400	white matt/chr.
2-30872-02	2-30872-H-02	400	black matt/chr.
2-30872-23	2-30872-H-23	400	anthracite matt/chr.
2-30881	2-30881-H	600	chrome matt
2-30882	2-30882-H	600	chrome
2-30883	2-30883-H	600	nickel matt
2-30882-22	2-30882-H-22	600	white matt/chr.
2-30882-02	2-30882-H-02	600	black matt/chr.
2-30882-23	2-30882-H-23	600	anthracite matt/chr.



chrome

► Ohne Zubehör. Bestell-Artikelnummern für Linse, Glas, Farbfilter und die Konfigurationsempfehlung (2) auf der Einklappseite!



► Without accessories: Order item-no. for lens, glass, color filter and the recommended Configuration (2) are on the fold-in page!

G9 max. 33W ECO, optional LED Retrofit
 G9 max. 33W ECO, LED Retrofit optional

Leuchtmittelempfehlung: LED max. 3W/300lm/2.700K/dimmbar Art. Nr. 8-205
 bulb recommendation: LED max. 3W/300Lm/2.700K/dimmable Item No. 8-205



- Chrom Teile/
chrome parts
- Gepulverte Teile/
powder-coating

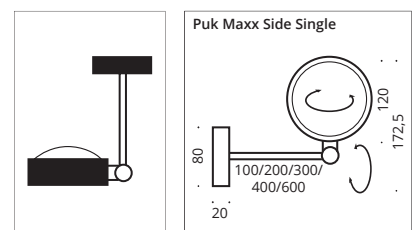





Puk Mini Side Twin \varnothing 80

Deckenleuchte, Hochvolt Halogen oder LED Power, dimmbar, Köpfe drehbar mit Verstellstift. Mit drehbarem Arm (bis 350°).

Ceiling lamp, high voltage halogen or LED power, dimmable, heads rotatable with adjusting pin. With rotatable arm (up to 350°).

INDOOR

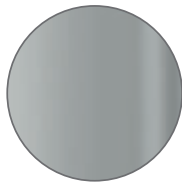

chrome matt

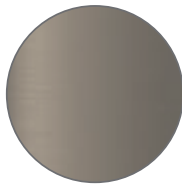

nickel matt

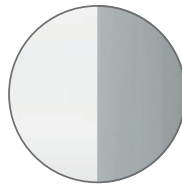

white matt/
chrome

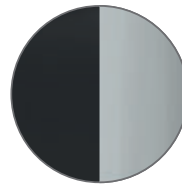

black matt/
chrome

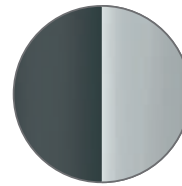

anthracite matt/
chrome

Puk Side Twin LED G 4 x 8W ~2.400lm ~2.700k	Puk Side Twin G9 Fassung G	Armlänge arm length in mm	Gehäuse body
● 2-0841-LED	2-0841	100	chrome matt
● 2-0842-LED	2-0842	100	chrome
● 2-0843-LED	2-0843	100	nickel matt
● 2-0842-LED-22	2-0842-22	100	white matt/chr.
● 2-0842-LED-02	2-0842-02	100	black matt/chr.
● 2-0842-LED-23	2-0842-23	100	anthracite matt/chr.
● 2-0851-LED	2-0851	200	chrome matt
● 2-0852-LED	2-0852	200	chrome
● 2-0853-LED	2-0853	200	nickel matt
● 2-0852-LED-22	2-0852-22	200	white matt/chr.
● 2-0852-LED-02	2-0852-02	200	black matt/chr.
● 2-0852-LED-23	2-0852-23	200	anthracite matt/chr.
● 2-0891-LED	2-0891	300	chrome matt
● 2-0892-LED	2-0892	300	chrome
● 2-0893-LED	2-0893	300	nickel matt
● 2-0892-LED-22	2-0892-22	300	white matt/chr.
● 2-0892-LED-02	2-0892-02	300	black matt/chr.
● 2-0892-LED-23	2-0892-23	300	anthracite matt/chr.
● 2-08101-LED	2-08101	400	chrome matt
● 2-08102-LED	2-08102	400	chrome
● 2-08103-LED	2-08103	400	nickel matt
● 2-08102-LED-22	2-08102-22	400	white matt/chr.
● 2-08102-LED-02	2-08102-02	400	black matt/chr.
● 2-08102-LED-23	2-08102-23	400	anthracite matt/chr.
● 2-08111-LED	2-08111	600	chrome matt
● 2-08112-LED	2-08112	600	chrome
● 2-08113-LED	2-08113	600	nickel matt
● 2-08112-LED-22	2-08112-22	600	white matt/chr.
● 2-08112-LED-02	2-08112-02	600	black matt/chr.
● 2-08112-LED-23	2-08112-23	600	anthracite matt/chr.



chrome

- Chrom Teile/
chrome parts
- Gepulverte Teile/
powder-coating

▶ Ohne Zubehör. Bestell-Artikelnummern für Linse, Glas, Farbfilter und die Konfigurationsempfehlung (2) auf der Einklappseite!

▶ Without accessories: Order item-no. for lens, glass, color filter and the recommended Configuration (2) are on the fold-in page!

G9 max. 33W ECO, optional LED Retrofit
 G9 max. 33W ECO, LED Retrofit optional

Leuchtmittelempfehlung: LED max. 3W/300lm/2.700K/dimmbar **G** Art. Nr. 8-205
 bulb recommendation: LED max. 3W/300Lm/2.700K/dimmable **G** Item No. 8-205

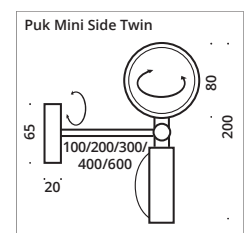
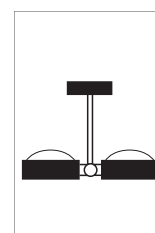





Puk Maxx Side Twin ø 120

Deckenleuchte mit Arm, Hochvolt Halogen oder LED Power, Köpfe drehbar. Mit drehbarem Arm (bis 350°).

Ceiling lamp with arm, high voltage halogen or LED power, heads rotatable. With rotatable arm (up to 350°).

INDOOR

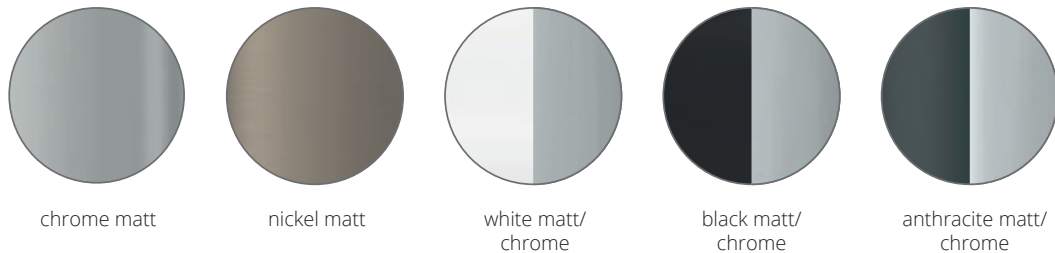

Puk Maxx Side Twin LED 4 x 12W ~3.600lm ~2.700k	Puk Maxx Side Twin G9 Fassung	Armlänge arm length in mm	Gehäuse body
2-30841	2-30841-H	100	chrome matt
2-30842	2-30842-H	100	chrome
2-30843	2-30843-H	100	nickel matt
2-30842-22	2-30842-H-22	100	white matt/chr.
2-30842-02	2-30842-H-02	100	black matt/chr.
2-30842-23	2-30842-H-23	100	anthracite matt/chr.
2-30851	2-30851-H	200	chrome matt
2-30852	2-30852-H	200	chrome
2-30853	2-30853-H	200	nickel matt
2-30852-22	2-30852-H-22	200	white matt/chr.
2-30852-02	2-30852-H-02	200	black matt/chr.
2-30852-23	2-30852-H-23	200	anthracite matt/chr.
2-30891	2-30891-H	300	chrome matt
2-30892	2-30892-H	300	chrome
2-30893	2-30893-H	300	nickel matt
2-30892-22	2-30892-H-22	300	white matt/chr.
2-30892-02	2-30892-H-02	300	black matt/chr.
2-30892-23	2-30892-H-23	300	anthracite matt/chr.
2-308101	2-308101-H	400	chrome matt
2-308102	2-308102-H	400	chrome
2-308103	2-308103-H	400	nickel matt
2-308102-22	2-308102-H-22	400	white matt/chr.
2-308102-02	2-308102-H-02	400	black matt/chr.
2-308102-23	2-308102-H-23	400	anthracite matt/chr.
2-308111	2-308111-H	600	chrome matt
2-308112	2-308112-H	600	chrome
2-308113	2-308113-H	600	nickel matt
2-308112-22	2-308112-H-22	600	white matt/chr.
2-308112-02	2-308112-H-02	600	black matt/chr.
2-308112-23	2-308112-H-23	600	anthracite matt/chr.



▶ Ohne Zubehör. Bestell-Artikelnummern für Linse, Glas, Farbfilter und die Konfigurationsempfehlung (2) auf der Einklappseite!



▶ Without accessories: Order item-no. for lens, glass, color filter and the recommended Configuration (2) are on the fold-in page!

G9 max. 33W ECO, optional LED Retrofit
 G9 max. 33W ECO, LED Retrofit optional

Leuchtmittelpfehlung: LED max. 3W/300lm/2.700K/dimmbar Art. Nr. 8-205
 bulb recommendation: LED max. 3W/300Lm/2.700K/dimmable Item No. 8-205

Chrom Teile/
chrome parts
 Gepulverte Teile/
powder-coating

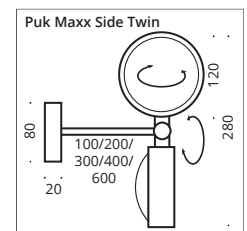
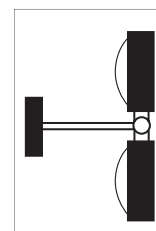





Puk Mini Wing Single ø 80

Deckenleuchte, Hochvolt Halogen oder LED Power, dimmbar, Kopf drehbar mit Verstellstift, Arm schwenkbar.

Ceiling lamp, high voltage halogen or LED power, dimmable, head rotatable with adjusting pin, arm pivoting.

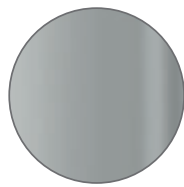

chrome matt

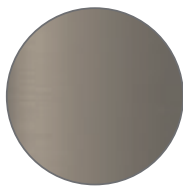

nickel matt

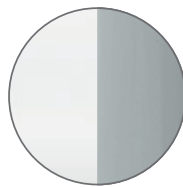

white matt/
chrome

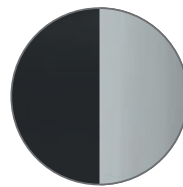

black matt/
chrome

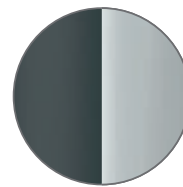

anthracite matt/
chrome

Puk Wing Single LED G 2 x 8W ~1.200lm ~2.700k	Puk Wing Single G9 Fassung	Armlänge arm length in mm	Gehäuse body
2-08201-LED	2-08201	200	chrome matt
2-08202-LED	2-08202	200	chrome
2-08203-LED	2-08203	200	nickel matt
2-08202-LED-22	2-08202-22	200	white/chrome
2-08202-LED-02	2-08202-02	200	black/chrome
2-08202-LED-23	2-08202-23	200	anthracite matt/chr.
2-08301-LED	2-08301	300	chrome matt
2-08302-LED	2-08302	300	chrome
2-08303-LED	2-08303	300	nickel matt
2-08302-LED-22	2-08302-22	300	white/chrome
2-08302-LED-02	2-08302-02	300	black/chrome
2-08302-LED-23	2-08302-23	300	anthracite matt/chr.
2-08401-LED	2-08401	400	chrome matt
2-08402-LED	2-08402	400	chrome
2-08403-LED	2-08403	400	nickel matt
2-08402-LED-22	2-08402-22	400	white/chrome
2-08402-LED-02	2-08402-02	400	black/chrome
2-08402-LED	2-08402-23	400	anthracite matt/chr.
2-08601-LED	2-08601	600	chrome matt
2-08602-LED	2-08602	600	chrome
2-08603-LED	2-08603	600	nickel matt
2-08602-LED-22	2-08602-22	600	white/chrome
2-08602-LED-02	2-08602-02	600	black/chrome
2-08602-LED-23	2-08602-23	600	anthracite matt/chr.
2-08801-LED	2-08801	800	chrome matt
2-08802-LED	2-08802	800	chrome
2-08803-LED	2-08803	800	nickel matt
2-08802-LED-22	2-08802-22	800	white/chrome
2-08802-LED-02	2-08802-02	800	black/chrome
2-08802-LED-23	2-08802-23	800	anthracite matt/chr.
2-081001-LED	2-081001	1.000	chrome matt
2-081002-LED	2-081002	1.000	chrome
2-081003-LED	2-081003	1.000	nickel matt
2-081002-LED-22	2-081002-22	1.000	white/chrome
2-081002-LED-02	2-081002-02	1.000	black/chrome
2-081002-LED-23	2-081002-23	1.000	anthracite matt/chr.
2-081201-LED	2-081201	1.250	chrome matt
2-081202-LED	2-081202	1.250	chrome
2-081203-LED	2-081203	1.250	nickel matt
2-081202-LED-22	2-081202-22	1.250	white/chrome
2-081202-LED-02	2-081202-02	1.250	black/chrome
2-081202-LED-23	2-081202-23	1.250	anthracite matt/chr.



chrome

Gepulverteile /
powder-coating

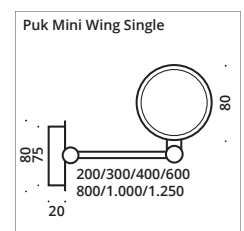
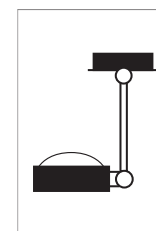

▶ Ohne Zubehör. Bestell-Artikelnummern für Linse, Glas, Farbfilter und die Konfigurationsempfehlung (2) auf der Einklappseite!



▶ Without accessories: Order item-no. for lens, glass, color filter and the recommended Configuration (2) are on the fold-in page!

G9 max. 33W ECO, optional LED Retrofit
 G9 max. 33W ECO, LED Retrofit optional

Leuchtmittelempfehlung: LED max. 3W/300lm/2.700K/dimmbar **G** Art. Nr. 8-205
 bulb recommendation: LED max. 3W/300Lm/2.700K/dimmable **G** Item No. 8-205



BC (s.S 6-7/s.p. 6-7)

INDOOR





Puk Maxx Wing Single ø 120

Deckenleuchte mit schwenkbarem Arm, Hochvolt Halogen oder LED Power, Kopf drehbar.

Ceiling lamp with adjustable arm, high voltage halogen or LED power, head rotatable.

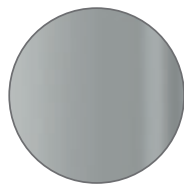

chrome matt

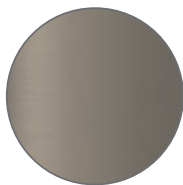

nickel matt

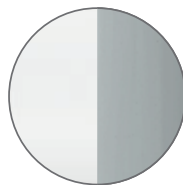

white matt/
chrome

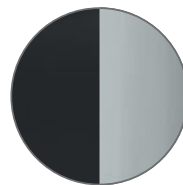

black matt/
chrome

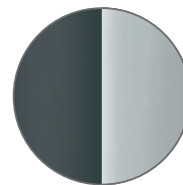

anthracite matt/
chrome

INDOOR

Puk Maxx Wing Single LED G 2 x 12W ~1.800lm ~2.700k	Puk Maxx Wing Single G9 Fassung	Armlänge arm length in mm	Gehäuse body
● 2-38201	2-38201-H	200	chrome matt
● 2-38202	2-38202-H	200	chrome
● 2-38203	2-38203-H	200	nickel matt
● 2-38202-22	2-38202-H-22	200	white matt/chr.
● 2-38202-02	2-38202-H-02	200	black matt/chr.
● 2-38202-23	2-38202-H-23	200	anthracite matt/chr.
● 2-38301	2-38301-H	300	chrome matt
● 2-38302	2-38302-H	300	chrome
● 2-38303	2-38303-H	300	nickel matt
● 2-38302-22	2-38302-H-22	300	white matt/chr.
● 2-38302-02	2-38302-H-02	300	black matt/chr.
● 2-38302-23	2-38302-H-23	300	anthracite matt/chr.
● 2-38401	2-38401-H	400	chrome matt
● 2-38402	2-38402-H	400	chrome
● 2-38403	2-38403-H	400	nickel matt
● 2-38402-22	2-38402-H-22	400	white matt/chr.
● 2-38402-02	2-38402-H-02	400	black matt/chr.
● 2-38402-23	2-38402-H-23	400	anthracite matt/chr.
● 2-38601	2-38601-H	600	chrome matt
● 2-38602	2-38602-H	600	chrome
● 2-38603	2-38603-H	600	nickel matt
● 2-38602-22	2-38602-H-22	600	white matt/chr.
● 2-38602-02	2-38602-H-02	600	black matt/chr.
● 2-38602-23	2-38602-H-23	600	anthracite matt/chr.
● 2-38801	2-38801-H	800	chrome matt
● 2-38802	2-38802-H	800	chrome
● 2-38803	2-38803-H	800	nickel matt
● 2-38802-22	2-38802-H-22	800	white matt/chr.
● 2-38802-02	2-38802-H-02	800	black matt/chr.
● 2-38802-23	2-38802-H-23	800	anthracite matt/chr.
● 2-381001	2-381001-H	1.000	chrome matt
● 2-381002	2-381002-H	1.000	chrome
● 2-381003	2-381003-H	1.000	nickel matt
● 2-381002-22	2-381002-H-22	1.000	white matt/chr.
● 2-381002-02	2-381002-H-02	1.000	black matt/chr.
● 2-381002-23	2-381002-H-23	1.000	anthracite matt/chr.
● 2-381201	2-381201-H	1.250	chrome matt
● 2-381202	2-381202-H	1.250	chrome
● 2-381203	2-381203-H	1.250	nickel matt
● 2-381202-22	2-381202-H-22	1.250	white matt/chr.
● 2-381202-02	2-381202-H-02	1.250	black matt/chr.
● 2-381202-23	2-381202-H-23	1.250	anthracite matt/chr.



chrome

- Chrom Teile/
chrome parts
- Gepulverte Teile/
powder-coating

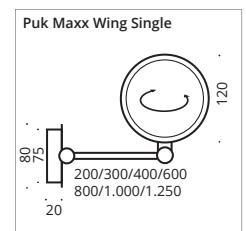
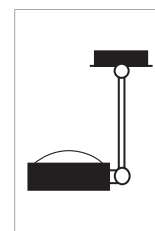

- ▶ Ohne Zubehör. Bestell-Artikelnummern für Linse, Glas, Farbfilter und die Konfigurationsempfehlung (2) auf der Einklappseite!
- ▶ Without accessories: Order item-no. for lens, glass, color filter and the recommended Configuration (2) are on the fold-in page!

G9 max. 33W ECO, optional LED Retrofit
 G9 max. 33W ECO, LED Retrofit optional

Leuchtmittelempfehlung: LED max. 3W/300lm/2.700K/dimmbar Art. Nr. 8-205
 bulb recommendation: LED max. 3W/300lm/2.700K/dimmable Item No. 8-205



BC (s.S 6-7/s.p. 6-7)





Puk Mini Wing Twin ø 80

Deckenleuchte, Hochvolt Halogen oder LED Power, dimmbar, Köpfe drehbar mit Verstellstift, Arm schwenkbar.

Ceiling lamp, high voltage halogen or LED power, dimmable, heads rotatable with adjusting pin, arm pivoting.

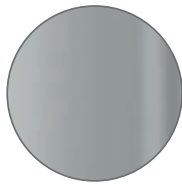

chrome matt

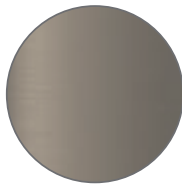

nickel matt

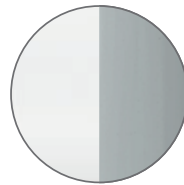

white matt/
chrome

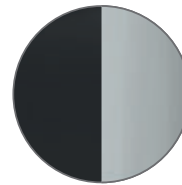

black matt/
chrome

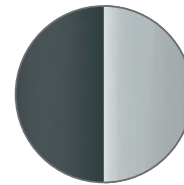

anthracite matt/
chrome

Puk Wing Twin LED G 4 x 8W ~2.400lm ~2.700k	Puk Wing Twin G9 Fassung	Armlänge arm length in mm	Gehäuse body
● 2-09201-LED	2-09201	200	chrome matt
● 2-09202-LED	2-09202	200	chrome
● 2-09203-LED	2-09203	200	nickel matt
● 2-09202-LED-22	2-09202-22	200	white matt/chr.
● 2-09202-LED-02	2-09202-02	200	black matt/chr.
● 2-09202-LED-23	2-09202-23	200	anthracite matt/chr.
● 2-09301-LED	2-09301	300	chrome matt
● 2-09302-LED	2-09302	300	chrome
● 2-09303-LED	2-09303	300	nickel matt
● 2-09302-LED-22	2-09302-22	300	white matt/chr.
● 2-09302-LED-02	2-09302-02	300	black matt/chr.
● 2-09302-LED-23	2-09302-23	300	anthracite matt/chr.
● 2-09401-LED	2-09401	400	chrome matt
● 2-09402-LED	2-09402	400	chrome
● 2-09403-LED	2-09403	400	nickel matt
● 2-09402-LED-22	2-09402-22	400	white matt/chr.
● 2-09402-LED-02	2-09402-02	400	black matt/chr.
● 2-09402-LED-23	2-09402-23	400	anthracite matt/chr.
● 2-09601-LED	2-09601	600	chrome matt
● 2-09602-LED	2-09602	600	chrome
● 2-09603-LED	2-09603	600	nickel matt
● 2-09602-LED-22	2-09602-22	600	white matt/chr.
● 2-09602-LED-02	2-09602-02	600	black matt/chr.
● 2-09602-LED-23	2-09602-23	600	anthracite matt/chr.
● 2-09801-LED	2-09801	800	chrome matt
● 2-09802-LED	2-09802	800	chrome
● 2-09803-LED	2-09803	800	nickel matt
● 2-09802-LED-22	2-09802-22	800	white matt/chr.
● 2-09802-LED-02	2-09802-02	800	black matt/chr.
● 2-09802-LED-23	2-09802-23	800	anthracite matt/chr.
● 2-091001-LED	2-091001	1.000	chrome matt
● 2-091002-LED	2-091002	1.000	chrome
● 2-091003-LED	2-091003	1.000	nickel matt
● 2-091002-LED-22	2-091002-22	1.000	white matt/chr.
● 2-091002-LED-02	2-091002-02	1.000	black matt/chr.
● 2-091002-LED-23	2-091002-23	1.000	anthracite matt/chr.
● 2-091201-LED	2-091201	1.250	chrome matt
● 2-091202-LED	2-091202	1.250	chrome
● 2-091203-LED	2-091203	1.250	nickel matt
● 2-091202-LED-22	2-091202-22	1.250	white matt/chr.
● 2-091202-LED-02	2-091202-02	1.250	black matt/chr.
● 2-091202-LED-23	2-091202-23	1.250	anthracite matt/chr.



chrome

- Chrom Teile/
chrome parts
- Gepulverte Teile/
powder-coating

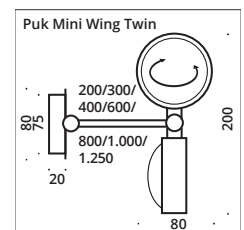
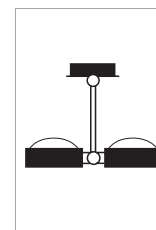

▶ Ohne Zubehör. Bestell-Artikelnummern für Linse, Glas, Farbfilter und die Konfigurationsempfehlung (2) auf der Einklappseite!



▶ Without accessories: Order item-no. for lens, glass, color filter and the recommended Configuration (2) are on the fold-in page!

G9 max. 33W ECO, optional LED Retrofit
G9 max. 33W ECO, LED Retrofit optional

Leuchtmittelempfehlung: LED max. 3W/300lm/2.700K/dimmbar **G** Art. Nr. 8-205
bulb recommendation: LED max. 3W/300lm/2.700K/dimmable **G** Item No. 8-205



BC (s.S 6-7/s.p. 6-7)



Puk Maxx Wing Twin



Puk Maxx Wing Twin ø 120

Deckenleuchte mit schwenkbarem Arm, Hochvolt Halogen oder LED Power, Köpfe drehbar.

Ceiling lamp with adjustable arm, high voltage halogen or LED power, heads rotatable.

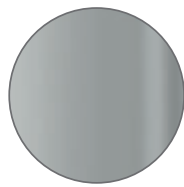

chrome matt

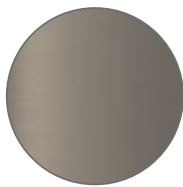

nickel matt

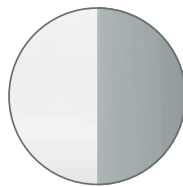

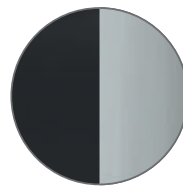

white matt/
chrome

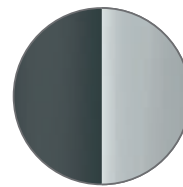

black matt/
chrome





anthracite matt/
chrome

Puk Maxx Wing Twin LED  4 x 12W ~3.600lm ~2.700k	Puk Maxx Wing Twin G9 Fassung 	Armlänge arm length in mm	Gehäuse body
● 2-39201	2-39201-H	200	chrome matt
● 2-39202	2-39202-H	200	chrome
● 2-39203	2-39203-H	200	nickel matt
● 2-39202-22	2-39202-H-22	200	white matt/chr.
● 2-39202-02	2-39202-H-02	200	black matt/chr.
● 2-39202-23	2-39202-H-23	200	anthracite matt/chr.
● 2-39301	2-39301-H	300	chrome matt
● 2-39302	2-39302-H	300	chrome
● 2-39303	2-39303-H	300	nickel matt
● 2-39302-22	2-39302-H-22	300	white matt/chr.
● 2-39302-02	2-39302-H-02	300	black matt/chr.
● 2-39302-23	2-39302-H-23	300	anthracite matt/chr.
● 2-39401	2-39401-H	400	chrome matt
● 2-39402	2-39402-H	400	chrome
● 2-39403	2-39403-H	400	nickel matt
● 2-39402-22	2-39402-H-22	400	white matt/chr.
● 2-39402-02	2-39402-H-02	400	black matt/chr.
● 2-39402-23	2-39402-H-23	400	anthracite matt/chr.
● 2-39601	2-39601-H	600	chrome matt
● 2-39602	2-39602-H	600	chrome
● 2-39603	2-39603-H	600	nickel matt
● 2-39602-22	2-39602-H-22	600	white matt/chr.
● 2-39602-02	2-39602-H-02	600	black matt/chr.
● 2-39602-23	2-39602-H-23	600	anthracite matt/chr.
● 2-39801	2-39801-H	800	chrome matt
● 2-39802	2-39802-H	800	chrome
● 2-39803	2-39803-H	800	nickel matt
● 2-39802-22	2-39802-H-22	800	white matt/chr.
● 2-39802-02	2-39802-H-02	800	black matt/chr.
● 2-39802-23	2-39802-H-23	800	anthracite matt/chr.
● 2-391001	2-391001-H	1.000	chrome matt
● 2-391002	2-391002-H	1.000	chrome
● 2-391003	2-391003-H	1.000	nickel matt
● 2-391002-22	2-391002-H-22	1.000	white matt/chr.
● 2-391002-02	2-391002-H-02	1.000	black matt/chr.
● 2-391002-23	2-391002-H-23	1.000	anthracite matt/chr.
● 2-391201	2-391201-H	1.250	chrome matt
● 2-391202	2-391202-H	1.250	chrome
● 2-391203	2-391203-H	1.250	nickel matt
● 2-391202-22	2-391202-H-22	1.250	white matt/chr.
● 2-391202-02	2-391202-H-02	1.250	black matt/chr.
● 2-391202-23	2-391202-H-23	1.250	anthracite matt/chr.



chrome

 Chrom Teile/
chrome parts
 Gepulverte Teile/
powder-coating

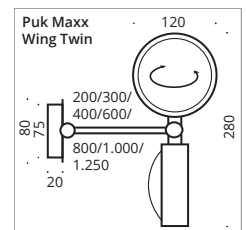
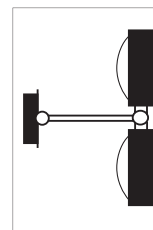



▶ Ohne Zubehör. Bestell-Artikelnummern für Linse, Glas, Farbfilter und die Konfigurationsempfehlung (2) auf der Einklappseite!



▶ Without accessories: Order item-no. for lens, glass, color filter and the recommended Configuration (2) are on the fold-in page!

 G9 max. 33W ECO, optional LED Retrofit
 G9 max. 33W ECO, LED Retrofit optional

 Leuchtmittelempfehlung: LED max. 3W/300lm/2.700K/dimmbar  Art. Nr. 8-205
 bulb recommendation: LED max. 3W/300lm/2.700K/dimmable  Item No. 8-205



 BC (s.S 6-7/s.p. 6-7)





Puk Maxx Next ø 120

Deckenleuchte, Hochvolt LED Power oder Hochvolt Halogen, dimmbar. Diese Aufbauleuchte wurde für den Wand- und Deckeneinsatz konstruiert. Mit zwei kardanis aufeinander abgestimmten Gelenken, lassen sich die Leuchtenköpfe um über 360 Grad auf zwei Achsen in jede Richtung einstellen.

Ceiling lamp, high voltage LED power or high voltage halogen, dimmable. The shaped lamp is dimmable and has been designed for ceilings and walls. With its two coordinated gimbal-joints the head can be turned in two axes for more than over 360° in each direction.

INDOOR

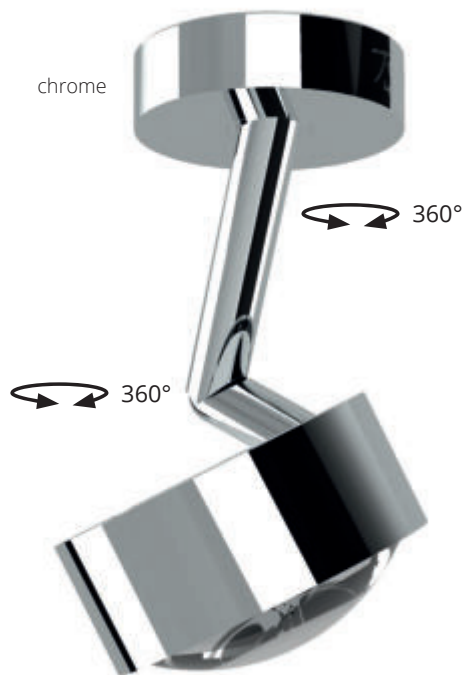
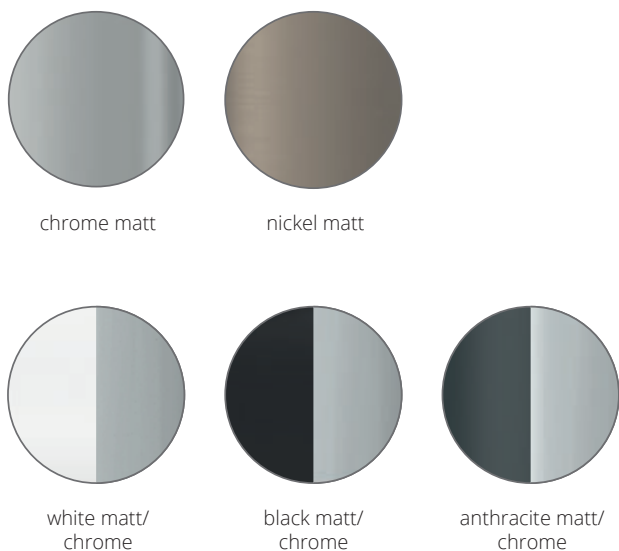

Puk Maxx Next LED ~2.700k	Puk Maxx Next G9 Fassung	Kopf ø Head ø in mm	Gehäuse body
downlight 1 x 12W, ~900lm	downlight		
2-30721	2-30721-H	120	chrome matt
2-30722	2-30722-H	120	chrome
2-30723	2-30723-H	120	nickel matt
2-30722-22	2-30722-H-22	120	white matt/chr.
2-30722-02	2-30722-H-02	120	black matt/chr.
2-30722-23	2-30722-H-23	120	anthracite matt/chr.
up- & downlight 2 x 12W, ~1.800lm	up- & downlight		
2-30731	2-30731-H	120	chrome matt
2-30732	2-30732-H	120	chrome
2-30733	2-30733-H	120	nickel matt
2-30732-22	2-30732-H-22	120	white matt/chr.
2-30732-02	2-30732-H-02	120	black matt/chr.
2-30732-23	2-30732-H-23	120	anthracite matt/chr.

- ▶ Ohne Zubehör. Bestell-Artikelnummern für Linse, Glas, Farbfilter und die Konfigurationsempfehlung (2) auf der Einklappseite!
- ▶ Without accessories: Order item-no. for lens, glass, color filter and the recommended Configuration (2) are on the fold-in page!

- G9 max. 33W ECO, optional LED Retrofit
- G9 max. 33W ECO, LED Retrofit optional
- Leuchtmittelempfehlung: LED max. 3W/300lm/2.700K/dimmbar Art. Nr. 8-205
- bulb recommendation: LED max. 3W/300Lm/2.700K/dimmable Item No. 8-205

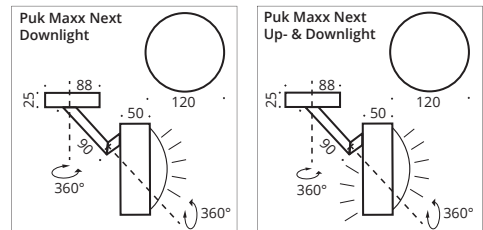
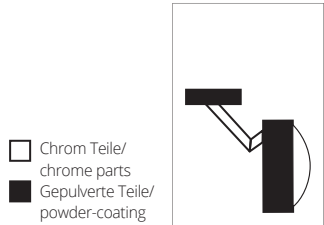





Puk Meg Maxx Next ø 160

Diese Aufbauleuchte wurde für den Wand- und Deckeneinsatz konstruiert, dimmbar. Mit zwei kardanis aufeinander abgestimmten Gelenken, lassen sich die LED oder Halogen Leuchtenköpfe um über 360° drehen.

The shaped lamp is dimmable and has been designed for ceilings and walls. With its two coordinated gimbaled joints the LED or halogen lighted head can be turned for more than over 360°.

INDOOR

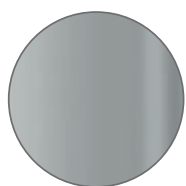

chrome matt



nickel matt

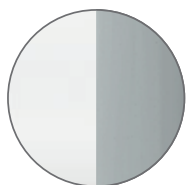

white matt/
chrome

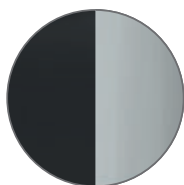

black matt/
chrome

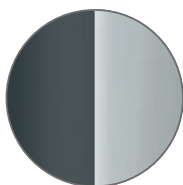

anthracite matt/
chrome

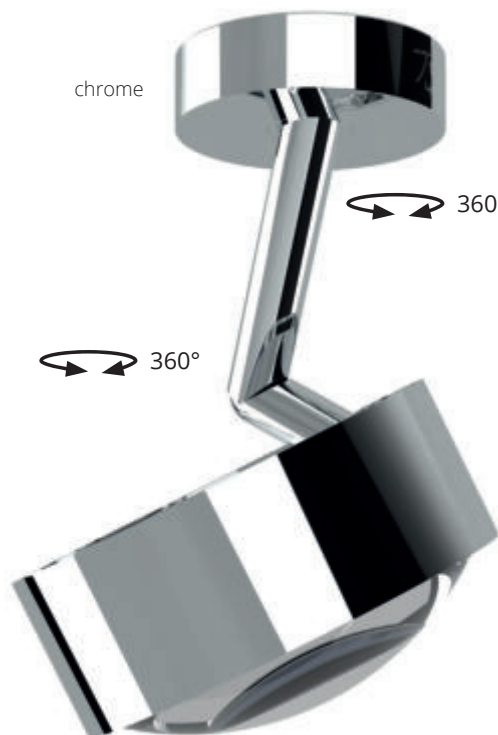

Puk Meg Maxx Next LED G ~2.700k	Puk Meg Maxx Next G9 Fassung	Kopf ø Head ø in mm	Gehäuse body
downlight 1 x 16W, ~1.200lm	downlight		
● 2-50721	2-50721-H	160	chrome matt
● 2-50722	2-50722-H	160	chrome
● 2-50723	2-50723-H	160	nickel matt
● 2-50722-22	2-50722-H-22	160	white matt/chr.
● 2-50722-02	2-50722-H-02	160	black matt/chr.
● 2-50722-23	2-50722-H-23	160	anthracite matt/chr.
up- & downlight 2 x 16W, ~2.400lm	up- & downlight		
● 2-50731	2-50731-H	160	chrome matt
● 2-50732	2-50732-H	160	chrome
● 2-50733	2-50733-H	160	nickel matt
● 2-50732-22	2-50732-H-22	160	white matt/chr.
● 2-50732-02	2-50732-H-02	160	black matt/chr.
● 2-50732-23	2-50732-H-23	160	anthracite matt/chr.

▶ Ohne Zubehör. Bestell-Artikelnummern für Linse, Glas, Farbfilter und die Konfigurationsempfehlung (2) auf der Einklappseite!



▶ Without accessories: Order item-no. for lens, glass, color filter and the recommended Configuration (2) are on the fold-in page!

💡 G9 max. 33W ECO, optional LED Retrofit
💡 G9 max. 33W ECO, LED Retrofit optional

💡 Leuchtmittelempfehlung: LED max. 3W/300lm/2.700K/dimmbar **G** Art. Nr. 8-205
💡 bulb recommendation: LED max. 3W/300Lm/2.700K/dimmable **G** Item No. 8-205

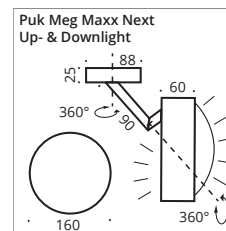
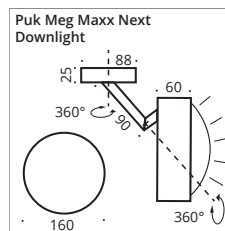
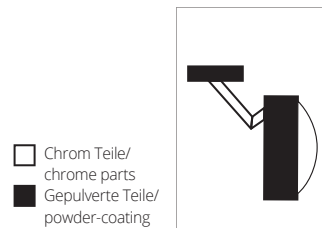



Puk Mini Ceiling Sister Twin



Puk Mini Ceiling Sister Twin ø 80

Deckenleuchte, Hochvolt Halogen oder LED Power, dimmbar, Köpfe drehbar mit Verstellstift, Arme schwenkbar.
Ceiling lamp, high voltage halogen or LED power, dimmable, heads rotatable with adjusting pin, arms titable.

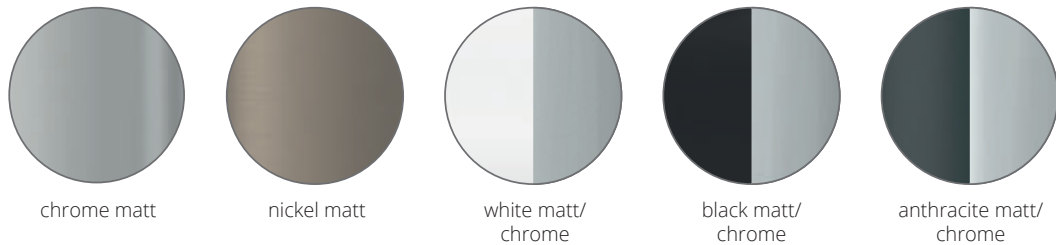

INDOOR

Puk Ceiling Sister LED G 8 x 8W ~4.800lm ~2.700k	Puk Ceiling Sister G9 Fassung	Arm Länge arm length in mm	Gehäuse body
● 5-081201-2-LED	5-081201-2	200	chrome matt
● 5-081202-2-LED	5-081202-2	200	chrome
● 5-081203-2-LED	5-081203-2	200	nickel matt
● 5-081202-2-LED-22	5-081202-2-22	200	white matt/chr.
● 5-081202-2-LED-02	5-081202-2-02	200	black matt/chr.
● 5-081202-2-LED-23	5-081202-2-23	200	anthracite matt/chr.
● 5-081401-2-LED	5-081401-2	400	chrome matt
● 5-081402-2-LED	5-081402-2	400	chrome
● 5-081403-2-LED	5-081403-2	400	nickel matt
● 5-081402-2-LED-22	5-081402-2-22	400	white matt/chr.
● 5-081402-2-LED-02	5-081402-2-02	400	black matt/chr.
● 5-081402-2-LED-23	5-081402-2-23	400	anthracite matt/chr.
● 5-081601-2-LED	5-081601-2	600	chrome matt
● 5-081602-2-LED	5-081602-2	600	chrome
● 5-081603-2-LED	5-081603-2	600	nickel matt
● 5-081602-2-LED-22	5-081602-2-22	600	white matt/chr.
● 5-081602-2-LED-02	5-081602-2-02	600	black matt/chr.
● 5-081602-2-LED-23	5-081602-2-23	600	anthracite matt/chr.
● 5-081801-2-LED	5-081801-2	800	chrome matt
● 5-081802-2-LED	5-081802-2	800	chrome
● 5-081803-2-LED	5-081803-2	800	nickel matt
● 5-081802-2-LED-22	5-081802-2-22	800	white matt/chr.
● 5-081802-2-LED-02	5-081802-2-02	800	black matt/chr.
● 5-081802-2-LED-23	5-081802-2-23	800	anthracite matt/chr.
● 5-0811001-2-LED	5-0811001-2	1.000	chrome matt
● 5-0811002-2-LED	5-0811002-2	1.000	chrome
● 5-0811003-2-LED	5-0811003-2	1.000	nickel matt
● 5-0811002-2-LED-22	5-0811002-2-22	1.000	white matt/chr.
● 5-0811002-2-LED-02	5-0811002-2-02	1.000	black matt/chr.
● 5-0811002-2-LED-23	5-0811002-2-23	1.000	anthracite matt/chr.
● 5-0811201-2-LED	5-0811201-2	1.250	chrome matt
● 5-0811202-2-LED	5-0811202-2	1.250	chrome
● 5-0811203-2-LED	5-0811203-2	1.250	nickel matt
● 5-0811202-2-LED-22	5-0811202-2-22	1.250	white matt/chr.
● 5-0811202-2-LED-02	5-0811202-2-02	1.250	black matt/chr.
● 5-0811202-2-LED-23	5-0811202-2-23	1.250	anthracite matt/chr.



► Ohne Zubehör. Bestell-Artikelnummern für Linse, Glas, Farbfilter und die Konfigurationsempfehlung (2) auf der Einklappseite!



► Without accessories: Order item-no. for lens, glass, color filter and the recommended Configuration (2) are on the fold-in page!

G9 max. 33W ECO, optional LED Retrofit
 G9 max. 33W ECO, LED Retrofit optional

Leuchtmittelempfehlung: LED max. 3W/300lm/2.700K/dimmbar **G** Art. Nr. 8-205
 bulb recommendation: LED max. 3W/300Lm/2.700K/dimmable **G** Item No. 8-205



BC (s.S 6-7/s.p. 6-7)

Chrom Teile/
chrome parts
 Gepulverte Teile/
powder-coating

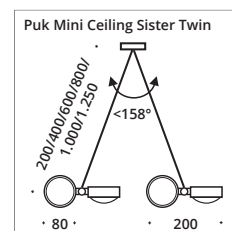





Puk Maxx Ceiling Sister Single ø 120

Deckenleuchte, Hochvolt Halogen oder LED Power, dimmbar, Köpfe drehbar, Arme schwenkbar.
Ceiling lamp, high voltage halogen or LED power, dimmable, heads rotatable, arms titable.

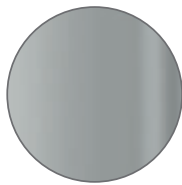

chrome matt

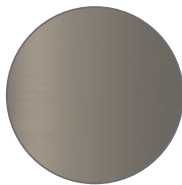

nickel matt

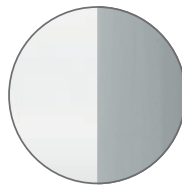

white matt/
chrome

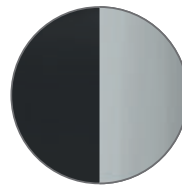

black matt/
chrome

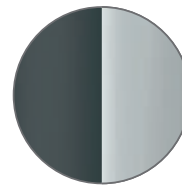

anthracite matt/
chrome

INDOOR

Puk Maxx Ceiling Sister LED 4 x 12W ~3.600lm ~2.700k	Puk Maxx Ceiling Sister G9 Fassung	Arm Länge arm length in mm	Gehäuse body
● 5-381201-2	5-381201-2-H	200	chrome matt
● 5-381202-2	5-381202-2-H	200	chrome
○ 5-381203-2	5-381203-2-H	200	nickel matt
● 5-381202-2-22	5-381202-2-H-22	200	white matt/chr.
● 5-381202-2-02	5-381202-2-H-02	200	black matt/chr.
● 5-381202-2-23	5-381202-2-H-23	200	anthracite matt/chr.
○ 5-381401-2	5-381401-2-H	400	chrome matt
○ 5-381402-2	5-381402-2-H	400	chrome
○ 5-381403-2	5-381403-2-H	400	nickel matt
● 5-381402-2-22	5-381402-2-H-22	400	white matt/chr.
● 5-381402-2-02	5-381402-2-H-02	400	black matt/chr.
● 5-381402-2-23	5-381402-2-H-23	400	anthracite matt/chr.
○ 5-381601-2	5-381601-2-H	600	chrome matt
○ 5-381602-2	5-381602-2-H	600	chrome
○ 5-381603-2	5-381603-2-H	600	nickel matt
● 5-381602-2-22	5-381602-2-H-22	600	white matt/chr.
● 5-381602-2-02	5-381602-2-H-02	600	black matt/chr.
● 5-381602-2-23	5-381602-2-H-23	600	anthracite matt/chr.
● 5-381801-2	5-381801-2-H	800	chrome matt
● 5-381802-2	5-381802-2-H	800	chrome
● 5-381803-2	5-381803-2-H	800	nickel matt
● 5-381802-2-22	5-381802-2-H-22	800	white matt/chr.
● 5-381802-2-02	5-381802-2-H-02	800	black matt/chr.
● 5-381802-2-23	5-381802-2-H-23	800	anthracite matt/chr.
● 5-3811001-2	5-3811001-2-H	1.000	chrome matt
● 5-3811002-2	5-3811002-2-H	1.000	chrome
○ 5-3811003-2	5-3811003-2-H	1.000	nickel matt
● 5-3811002-2-22	5-3811002-2-H-22	1.000	white matt/chr.
● 5-3811002-2-02	5-3811002-2-H-02	1.000	black matt/chr.
● 5-3811002-2-23	5-3811002-2-H-23	1.000	anthracite matt/chr.
● 5-3811201-2	5-3811201-2-H	1.250	chrome matt
● 5-3811202-2	5-3811202-2-H	1.250	chrome
○ 5-3811203-2	5-3811203-2-H	1.250	nickel matt
● 5-3811202-2-22	5-3811202-2-H-22	1.250	white matt/chr.
● 5-3811202-2-02	5-3811202-2-H-02	1.250	black matt/chr.
● 5-3811202-2-23	5-3811202-2-H-23	1.250	anthracite matt/chr.



chrome

► Ohne Zubehör. Bestell-Artikelnummern für Linse, Glas, Farbfilter und die Konfigurationsempfehlung (2) auf der Einklappseite!

► Without accessories: Order item-no. for lens, glass, color filter and the recommended Configuration (2) are on the fold-in page!

G9 max. 33W ECO, optional LED Retrofit
 G9 max. 33W ECO, LED Retrofit optional

Leuchtmittelempfehlung: LED max. 3W/300lm/2.700K/dimmbar Art. Nr. 8-205
 bulb recommendation: LED max. 3W/300Lm/2.700K/dimmable Item No. 8-205

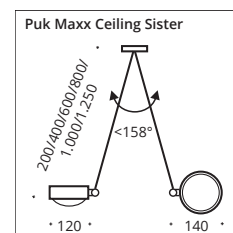

Chrom Teile/
chrome parts
 Gepulverte Teile/
powder-coating

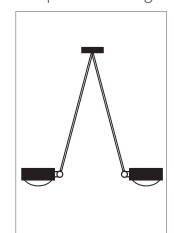





Puk Mini Choice Move ø 80

Deckenleuchte, Hochvolt LED Power oder Hochvolt Halogen, dimmbar. Der Lichtbalken besticht mit dreh- (360°) und schwenkbaren (±106°) Puk Mini Move Leuchten. Direktmontage an der Decke.

Ceiling lamp, high voltage LED power or high voltage halogen, dimmable. The light bar impresses with rotatable (360°) and swivelling (±106°) Puk Mini Move luminaires. For direct ceiling mounting.

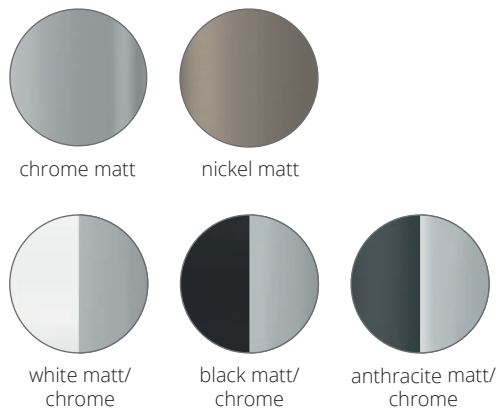

INDOOR

G9 Fassung

450 mm L 2 Köpfe/heads	850 mm L 3 Köpfe/heads	1.050 mm L 4 Köpfe/heads	1.250 mm L 4 Köpfe/heads	Gehäuse body
8-769401-H	8-769801-H	8-7691001-H	8-7691201-H	chrome matt
8-769402-H	8-769802-H	8-7691002-H	8-7691202-H	chrome
8-769403-H	8-769803-H	8-7691003-H	8-7691203-H	nickel matt
8-769402-H-22	8-769802-H-22	8-7691002-H-22	8-7691202-H-22	white matt/chrome
8-769402-H-02	8-769802-H-02	8-7691002-H-02	8-7691202-H-02	black matt/chrome
8-769402-H-23	8-769802-H-23	8-7691002-H-23	8-7691202-H-23	anthracite matt/chrome

Farbig gepulverter Lichtbalken auf Anfrage. Color powdered metal rail on request.

► Ohne Zubehör. Bestell-Artikelnummern für Linse, Glas, Farbfilter und die Konfigurationsempfehlung (2) auf der Einklappseite!

► Without accessories: Order item-no. for lens, glass, color filter and the recommended Configuration (2) are on the fold-in page!



G9 max. 3W ECO, optional LED Retrofit

G9 max. 3W ECO, LED Retrofit optional

Leuchtmittelempfehlung: LED max. 3W/300lm/2.700K/dimmbar **G** Art. Nr. 8-205

bulb recommendation: LED max. 3W/300Lm/2.700K/dimmable **G** Item No. 8-205

LED

450 mm L 2 Köpfe/heads G 2 x 8W, ~2.700k, ~1.200lm	850 mm L 3 Köpfe/heads G 3 x 8W, ~2.700k, ~1.800lm	1.050 mm L 4 Köpfe/heads G 4 x 8W, ~2.700k, ~2.400lm	1.250 mm L 4 Köpfe/heads G 4 x 8W, ~2.700k, ~2.400lm	Gehäuse body
8-769401	8-769801	8-7691001	8-7691201	chrome matt
8-769402	8-769802	8-7691002	8-7691202	chrome
8-769403	8-769803	8-7691003	8-7691203	nickel matt
8-769402-22	8-769802-22	8-7691002-22	8-7691202-22	white matt/chrome
8-769402-02	8-769802-02	8-7691002-02	8-7691202-02	black matt/chrome
8-769402-23	8-769802-23	8-7691002-23	8-7691202-23	anthracite matt/chrome

Farbig gepulverter Lichtbalken auf Anfrage. Color powdered metal rail on request.

► Ohne Zubehör. Bestell-Artikelnummern für Linse, Glas, Farbfilter und die Konfigurationsempfehlung (2) auf der Einklappseite!

► Without accessories: Order item-no. for lens, glass, color filter and the recommended Configuration (2) are on the fold-in page!



Sonderanfertigung:

Art-Nr. 8-600 Kürzung auf Maß

Item No. 8-600 Customized lengths

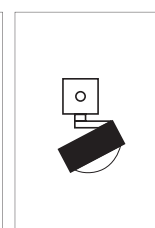
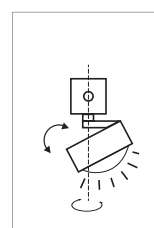
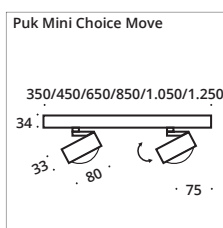

□ Chrom Teile/
chrome parts
■ Gepulverte Teile/
powder-coating





Puk Maxx Choice Move ø 120

Deckenleuchte, Hochvolt LED Power oder Hochvolt Halogen, dimmbar. Der Lichtbalken besteht mit dreh- (360°) und schwenkbaren (±106°) Puk Maxx Move Leuchten. Zur Direktmontage an der Decke.

Ceiling lamp, high voltage LED power or high voltage halogen, dimmable. The light bar impresses with rotatable (360°) and swivelling (± 106°) Puk Maxx Move luminaires. For direct ceiling mounting.

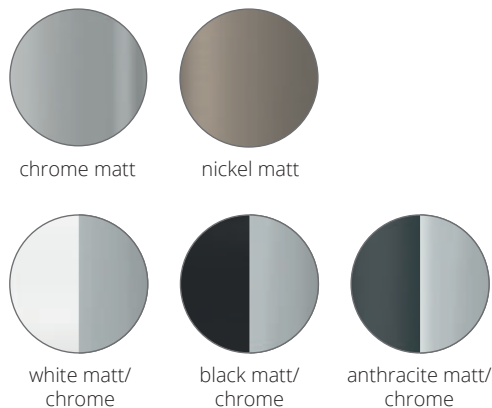

INDOOR

G9 Fassung

450 mm L 2 Köpfe/heads	850 mm L 3 Köpfe/heads	1.050 mm L 4 Köpfe/heads	1.250 mm L 4 Köpfe/heads	Gehäuse body
8-789401-H	8-789801-H	8-7891001-H	8-7891201-H	chrome matt
8-789402-H	8-789802-H	8-7891002-H	8-7891202-H	chrome
8-789403-H	8-789803-H	8-7891003-H	8-7891203-H	nickel matt
8-789402-H-22	8-789802-H-22	8-7891002-H-22	8-7891202-H-22	white matt/chrome
8-789402-H-02	8-789802-H-02	8-7891002-H-02	8-7891202-H-02	black matt/chrome
8-789402-H-23	8-789802-H-23	8-7891002-H-23	8-7891202-H-23	anthracite matt/chrome

Farbig gepulverter Lichtbalken auf Anfrage. Color powdered metal rail on request.

- ▶ Ohne Zubehör. Bestell-Artikelnummern für Linse, Glas, Farbfilter und die Konfigurationsempfehlung (2) auf der Einklappseite!
- ▶ Without accessories: Order item-no. for lens, glass, color filter and the recommended Configuration (2) are on the fold-in page!

- 💡 G9 max. 5W ECO, optional LED Retrofit
- 💡 G9 max. 5W ECO, LED Retrofit optional

- 💡 Leuchtmittlempfehlung: LED max. 3W/300lm/2.700K/dimmbar **G** Art. Nr. 8-205
- 💡 bulb recommendation: LED max. 3W/300lm/2.700K/dimmable **G** Item No. 8-205

LED

450 mm L 2 Köpfe/heads G 2 x 12W, ~2.700k, ~1.800lm	850 mm L 3 Köpfe/heads G 3 x 12W, ~2.700k, ~2.700lm	1.050 mm L 4 Köpfe/heads G 4 x 12W, ~2.700k, ~3.600lm	1.250 mm L 4 Köpfe/heads G 4 x 12W, ~2.700k, ~3.600lm	Gehäuse body
8-789401	8-789801	8-7891001	8-7891201	chrome matt
8-789402	8-789802	8-7891002	8-7891202	chrome
8-789403	8-789803	8-7891003	8-7891203	nickel matt
8-789402-22	8-789802-22	8-7891002-22	8-7891202-22	white matt/chrome
8-789402-02	8-789802-02	8-7891002-02	8-7891202-02	black matt/chrome
8-789402-23	8-789802-23	8-7891002-23	8-7891202-23	anthracite matt/chrome

Farbig gepulverter Lichtbalken auf Anfrage. Color powdered metal rail on request.

- ▶ Ohne Zubehör. Bestell-Artikelnummern für Linse, Glas, Farbfilter und die Konfigurationsempfehlung (2) auf der Einklappseite!
- ▶ Without accessories: Order item-no. for lens, glass, color filter and the recommended Configuration (2) are on the fold-in page!

Sonderanfertigung:
Art-Nr. 8-600 Kürzung auf Maß
Item No. 8-600 Customized lengths

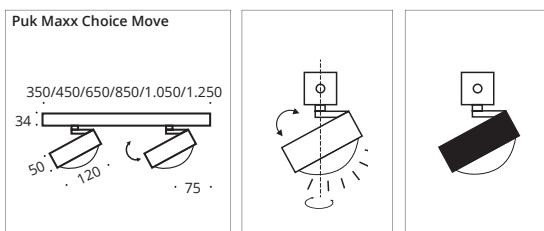

☐ Chrom Teile/
chrome parts
■ Gepulverte Teile/
powder-coating





Puk Mini Choice Turn Ø 80

Deckenleuchte, Hochvolt LED Power oder Hochvolt Halogen, dimmbar. Der Lichtbalken ist bestückt mit dreh- und schwenkbaren Puk Mini Turn Leuchten. Zur Direktmontage an der Decke.

Ceiling lamp, high voltage LED power or high voltage halogen, dimmable. The light bar is equipped with rotatable and swivelling Puk Mini Choice Turn luminaires. For direct ceiling mounting.

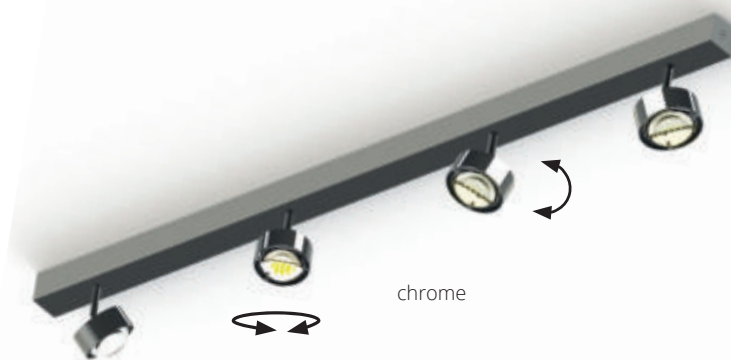
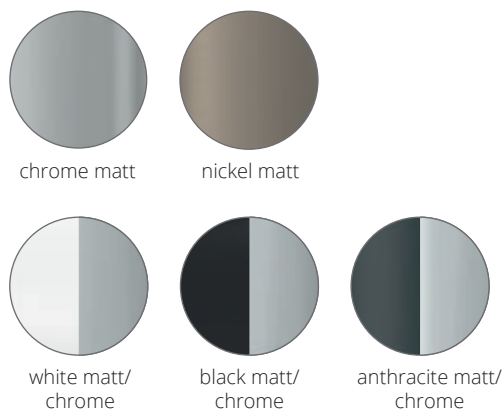

INDOOR

G9 Fassung

450 mm L 2 Köpfe/heads	850 mm L 3 Köpfe/heads	1.050 mm L 4 Köpfe/heads	1.250 mm L 4 Köpfe/heads	Gehäuse body
8-62284021-H	8-62288031-H	8-622810041-H	8-622812041-H	chrome matt
8-62284022-H	8-62288032-H	8-622810042-H	8-622812042-H	chrome
8-62284023-H	8-62288033-H	8-622810043-H	8-622812043-H	nickel matt
8-62284022-H-22	8-62288032-H-22	8-622810042-H-22	8-622812042-H-22	white matt/chrome
8-62284022-H-02	8-62288032-H-02	8-622810042-H-02	8-622812042-H-02	black matt/chrome
8-62284022-H-23	8-62288032-H-23	8-622810042-H-23	8-622812042-H-23	anthracite matt/chr.

Farbig gepulverter Lichtbalken auf Anfrage. Color powdered metal rail on request.

- ▶ Ohne Zubehör. Bestell-Artikelnummern für Linse, Glas, Farbfilter und die Konfigurationsempfehlung (2) auf der Einklappseite!
- ▶ Without accessories: Order item-no. for lens, glass, color filter and the recommended Configuration (2) are on the fold-in page!

G9 max. 33W ECO, optional LED Retrofit
G9 max. 33W ECO, LED Retrofit optional

Leuchtmittelempfehlung: LED max. 3W/300lm/2.700K/dimmbar **G** Art. Nr. 8-205
bulb recommendation: LED max. 3W/300Lm/2.700K/dimmable **G** Item No. 8-205

LED

450 mm L 2 Köpfe/heads G 4 x 8W, ~2.700k, ~2.400lm	850 mm L 3 Köpfe/heads G 6 x 8W, ~2.700k, ~3.600lm	1.050 mm L 4 Köpfe/heads G 8 x 8W, ~2.700k, ~4.800lm	1.250 mm L 4 Köpfe/heads G 8 x 8W, ~2.700k, ~4.800lm	Gehäuse body
8-62284021	8-62288031	8-622810041	8-622812041	chrome matt
8-62284022	8-62288032	8-622810042	8-622812042	chrome
8-62284023	8-62288033	8-622810043	8-622812043	nickel matt
8-62284022-22	8-62288032-22	8-622810042-22	8-622812042-22	white matt/chrome
8-62284022-02	8-62288032-02	8-622810042-02	8-622812042-02	black matt/chrome
8-62284022-23	8-62288032-23	8-622810042-23	8-622812042-23	anthracite matt/chr.

Farbig gepulverter Lichtbalken auf Anfrage. Color powdered metal rail on request.

- ▶ Ohne Zubehör. Bestell-Artikelnummern für Linse, Glas, Farbfilter und die Konfigurationsempfehlung (2) auf der Einklappseite!
- ▶ Without accessories: Order item-no. for lens, glass, color filter and the recommended Configuration (2) are on the fold-in page!

Sonderanfertigung:
Art-Nr. 8-600 Kürzung auf Maß
Item No. 8-600 Customized lengths

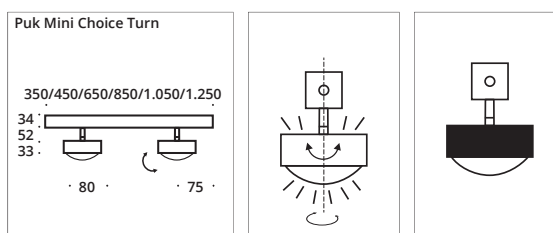





Puk Maxx Choice Turn ø 120

Deckenleuchte, Hochvolt LED Power oder Hochvolt Halogen, dimmbar. Der Lichtbalken ist bestückt mit dreh- und schwenkbaren Puk Maxx Turn Leuchten. Zur Direktmontage an der Decke.

Ceiling lamp, high voltage LED power or high voltage halogen, dimmable. The light bar is equipped with rotatable and swivelling Puk Maxx Choice Turn luminaires. For direct ceiling mounting.

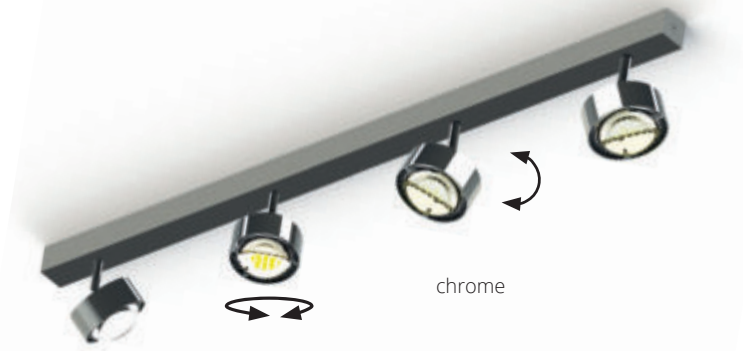
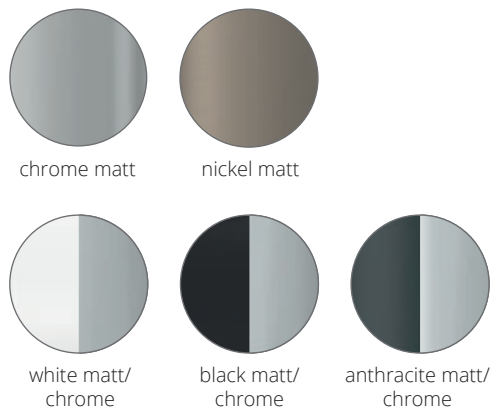

INDOOR

G9 Fassung

450 mm L 2 Köpfe/heads	850 mm L 3 Köpfe/heads	1.050 mm L 4 Köpfe/heads	1.250 mm L 4 Köpfe/heads	Gehäuse body
8-66284021-H	8-66288031-H	8-662810041-H	8-662812041-H	chrome matt
8-66284022-H	8-66288032-H	8-662810042-H	8-662812042-H	chrome
8-66284023-H	8-66288033-H	8-662810043-H	8-662812043-H	nickel matt
8-66284022-H-22	8-66288032-H-22	8-662810042-H-22	8-662812042-H-22	white matt/chrome
8-66284022-H-02	8-66288032-H-02	8-662810042-H-02	8-662812042-H-02	black matt/chrome
8-66284027-H-23	8-66288037-H-23	8-662810047-H-23	8-662812047-H-23	anthracite matt/chr.

Farbig gepulverter Lichtbalken auf Anfrage. Color powdered metal rail on request.

- ▶ Ohne Zubehör. Bestell-Artikelnummern für Linse, Glas, Farbfilter und die Konfigurationsempfehlung (2) auf der Einklappseite!
- ▶ Without accessories: Order item-no. for lens, glass, color filter and the recommended Configuration (2) are on the fold-in page!

G9 max. 33W ECO, optional LED Retrofit
 G9 max. 33W ECO, LED Retrofit optional

Leuchtmittelempfehlung: LED max. 3W/300lm/2.700K/dimmbar **G** Art. Nr. 8-205
 bulb recommendation: LED max. 3W/300lm/2.700K/dimmable **G** Item No. 8-205

LED

450 mm L 2 Köpfe/heads G 4 x 12W, ~2.700k, ~3.600lm	850 mm L 3 Köpfe/heads G 6 x 12W, ~2.700k, ~5.400lm	1.050 mm L 4 Köpfe/heads G 8 x 12W, ~2.700k, ~7.200lm	1.250 mm L 4 Köpfe/heads G 8 x 12W, ~2.700k, ~7.200lm	Gehäuse body
8-66284021	8-66288031	8-662810041	8-662812041	chrome matt
8-66284022	8-66288032	8-662810042	8-662812042	chrome
8-66284023	8-66288033	8-662810043	8-662812043	nickel matt
8-66284022-22	8-66288032-22	8-662810042-22	8-662812042-22	white matt/chrome
8-66284022-02	8-66288032-02	8-662810042-02	8-662812042-02	black matt/chrome
8-66284022-23	8-66288032-23	8-662810042-23	8-662812042-23	anthracite matt/chr.

Farbig gepulverter Lichtbalken = Preis auf Anfrage. Color powdered metal rail = price on request.

- ▶ Ohne Zubehör. Bestell-Artikelnummern für Linse, Glas, Farbfilter und die Konfigurationsempfehlung (2) auf der Einklappseite!
- ▶ Without accessories: Order item-no. for lens, glass, color filter and the recommended Configuration (2) are on the fold-in page!

Sonderanfertigung:
 Art-Nr. 8-600 Kürzung auf Maß
 Item No. 8-600 Customized lengths

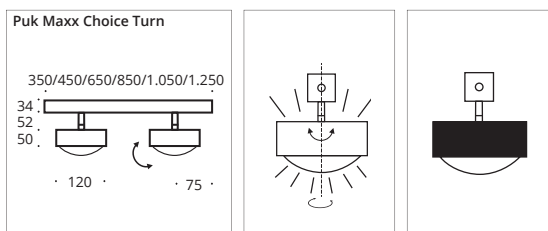

□ Chrom Teile/
chrome parts
■ Gepulverte Teile/
powder-coating





Puk Mini Choice Eye ø 80

Deckenleuchte, Hochvolt LED Power oder Hochvolt Halogen, dimmbar. Der Lichtbalken ist bestückt mit starren Puk Eye Leuchten (up- & downlight). Zur Direktmontage an der Decke.

Ceiling lamp, high voltage LED power or high voltage halogen, dimmable. The light bar is equipped with rigid Puk Mini Choice Eye luminaires (up- & downlight). For direct ceiling mounting.

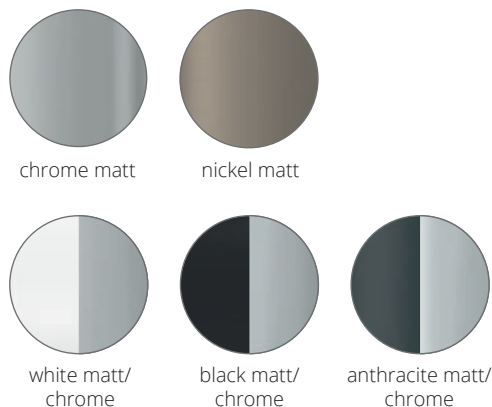

Fest installierte obere Linse. Permanently installed lens. chrome

INDOOR

G9 Fassung

450 mm L 2 Köpfe/heads	850 mm L 3 Köpfe/heads	1.050 mm L 4 Köpfe/heads	1.250 mm L 4 Köpfe/heads	Gehäuse body
8-6174021-H	8-6178031-H	8-61710041-H	8-61712041-H	chrome matt
8-6174022-H	8-6178032-H	8-61710042-H	8-61712042-H	chrome
8-6174023-H	8-6178033-H	8-61710043-H	8-61712043-H	nickel matt
8-6174022-H-22	8-6178032-H-22	8-61710042-H-22	8-61712042-H-22	white matt/chrome
8-6174022-H-02	8-6178032-H-02	8-61710042-H-02	8-61712042-H-02	black matt/chrome
8-6174022-H-23	8-6178032-H-23	8-61710042-H-23	8-61712042-H-23	anthracite matt/chr.

Farbig gepulverter Lichtbalken auf Anfrage. Color powdered metal rail on request.

- ▶ Ohne Zubehör. Bestell-Artikelnummern für Linse, Glas, Farbfilter und die Konfigurationsempfehlung (2) auf der Einklappseite!
- ▶ Without accessories: Order item-no. for lens, glass, color filter and the recommended Configuration (2) are on the fold-in page!

G9 max. 33W ECO, optional LED Retrofit
G9 max. 33W ECO, LED Retrofit optional

Leuchtmittlempfehlung: LED max. 3W/300lm/2.700K/dimmbar **G** Art. Nr. 8-205
bulb recommendation: LED max. 3W/300lm/2.700K/dimmable **G** Item No. 8-205

LED

450 mm L 2 Köpfe/heads G 4 x 8W, ~2.700k, ~2.400lm	850 mm L 3 Köpfe/heads G 6 x 8W, ~2.700k, ~3.600lm	1.050 mm L 4 Köpfe/heads G 8 x 8W, ~2.700k, ~4.800lm	1.250 mm L 4 Köpfe/heads G 8 x 8W, ~2.700k, ~4.800lm	Gehäuse body
8-6174021	8-6178031	8-61710041	8-61712041	chrome matt
8-6174022	8-6178032	8-61710042	8-61712042	chrome
8-6174023	8-6178033	8-61710043	8-61712043	nickel matt
8-6174022-22	8-6178032-22	8-61710042-22	8-61712042-22	white matt/chrome
8-6174022-02	8-6178032-02	8-61710042-02	8-61712042-02	black matt/chrome
8-6174022-23	8-6178032-23	8-61710042-23	8-61712042-23	anthracite matt/chr.

Farbig gepulverter Lichtbalken auf Anfrage. Color powdered metal rail on request.

- ▶ Ohne Zubehör. Bestell-Artikelnummern für Linse, Glas, Farbfilter und die Konfigurationsempfehlung (2) auf der Einklappseite!
- ▶ Without accessories: Order item-no. for lens, glass, color filter and the recommended Configuration (2) are on the fold-in page!

Sonderanfertigung:
Art-Nr. 8-600 Kürzung auf Maß
Item No. 8-600 Customized lengths

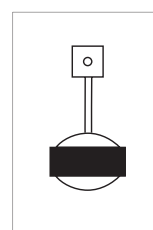
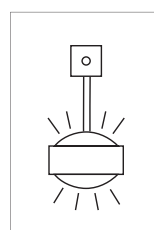
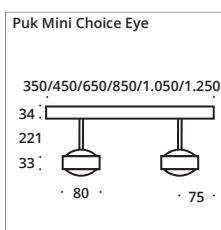

□ Chrom Teile/
chrome parts
■ Gepulverte Teile/
powder-coating





Puk Maxx Choice Eye ø 120

Deckenleuchte, Hochvolt LED Power oder Hochvolt Halogen, dimmbar. Der Lichtbalken ist bestückt mit starren Puk Maxx Choice Eye Leuchten (up- & downlight). Zur Direktmontage an der Decke.

Ceiling lamp, high voltage LED power or high voltage halogen, dimmable. The light bar is equipped with rigid Puk Maxx Choice Eye luminaires (up-& downlight). For direct ceiling mounting.

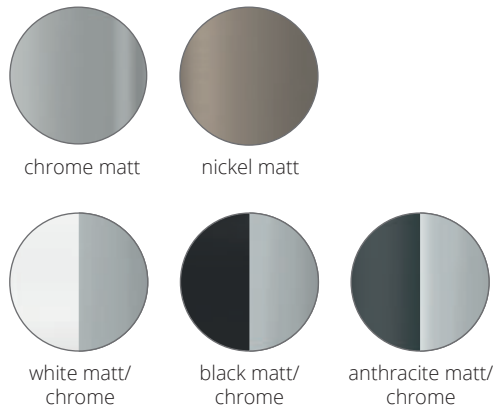

INDOOR

G9 Fassung

450 mm L 2 Köpfe/heads	850 mm L 3 Köpfe/heads	1.050 mm L 4 Köpfe/heads	1.250 mm L 4 Köpfe/heads	Gehäuse body
8-6974021-H	8-6978031-H	8-69710041-H	8-69712041-H	chrome matt
8-6974022-H	8-6978032-H	8-69710042-H	8-69712042-H	chrome
8-6974023-H	8-6978033-H	8-69710043-H	8-69712043-H	nickel matt
8-6974022-H-22	8-6978032-H-22	8-69710042-H-22	8-69712042-H-22	white matt/chrome
8-6974022-H-02	8-6978032-H-02	8-69710042-H-02	8-69712042-H-02	black matt/chrome
8-6974022-H-23	8-6978032-H-23	8-69710042-H-23	8-69712042-H-23	anthracite matt/chr.

Farbig gepulverter Lichtbalken auf Anfrage. Color powdered metal rail on request.

- ▶ Ohne Zubehör. Bestell-Artikelnummern für Linse, Glas, Farbfilter und die Konfigurationsempfehlung (2) auf der Einklappseite!
- ▶ Without accessories: Order item-no. for lens, glass, color filter and the recommended Configuration (2) are on the fold-in page!

- 💡 G9 max. 33W ECO, optional LED Retrofit
- ⚡ G9 max. 33W ECO, LED Retrofit optional

- 💡 Leuchtmittelempfehlung: LED max. 3W/300lm/2.700K/dimmbar **G** Art. Nr. 8-205
- ⚡ bulb recommendation: LED max. 3W/300lm/2.700K/dimmable **G** Item No. 8-205

LED

450 mm L 2 Köpfe/heads G 4 x 12W, ~2.700k, ~3.600lm	850 mm L 3 Köpfe/heads G 6 x 12W, ~2.700k, ~5.400lm	1.050 mm L 4 Köpfe/heads G 8 x 12W, ~2.700k, ~7.200lm	1.250 mm L 4 Köpfe/heads G 8 x 12W, ~2.700k, ~7.200lm	Gehäuse body
8-6974021	8-6978031	8-69710041	8-69712041	chrome matt
8-6974022	8-6978032	8-69710042	8-69712042	chrome
8-6974023	8-6978033	8-69710043	8-69712043	nickel matt
8-6974022-22	8-6978032-22	8-69710042-22	8-69712042-22	white matt/chrome
8-6974022-02	8-6978032-02	8-69710042-02	8-69712042-02	black matt/chrome
8-6974022-23	8-6978032-23	8-69710042-23	8-69712042-23	anthracite matt/chr.

Farbig gepulverter Lichtbalken auf Anfrage. Color powdered metal rail on request.

- ▶ Ohne Zubehör. Bestell-Artikelnummern für Linse, Glas, Farbfilter und die Konfigurationsempfehlung (2) auf der Einklappseite!
- ▶ Without accessories: Order item-no. for lens, glass, color filter and the recommended Configuration (2) are on the fold-in page!

Sonderanfertigung:
Art-Nr. 8-600 Kürzung auf Maß
Item No. 8-600 Customized lengths

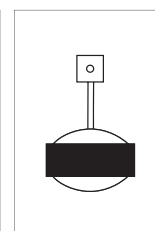
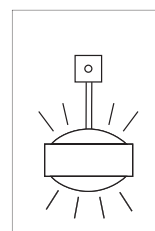
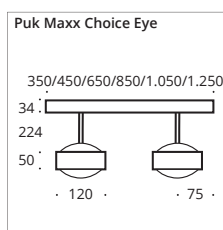

□ Chrom Teile/
chrome parts
■ Gepulverte Teile/
powder-coating





Puk Mini Choice Side ø 80

Deckenleuchte, Hochvolt LED Power oder Hochvolt Halogen, dimmbar. Der Lichtbalken ist bestückt mit dreh- und schwenkbaren Puk Side Leuchten. Zur Direktmontage an der Decke.

Ceiling lamp, high voltage LED power or high voltage halogen, dimmable. The light bar is equipped with rotatable and swivelling Puk Mini Choice Side luminaires. For direct ceiling mounting.

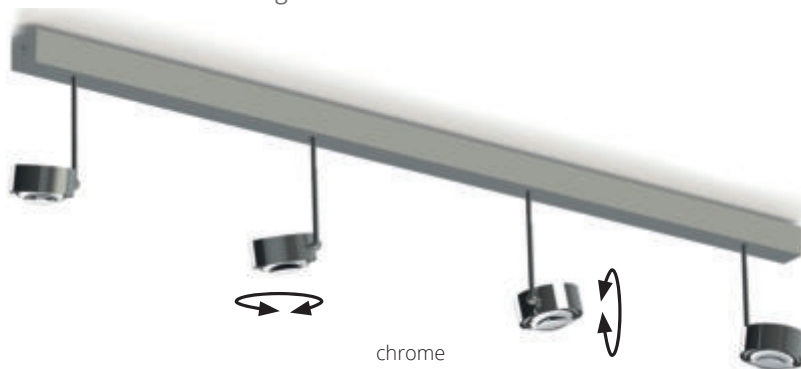
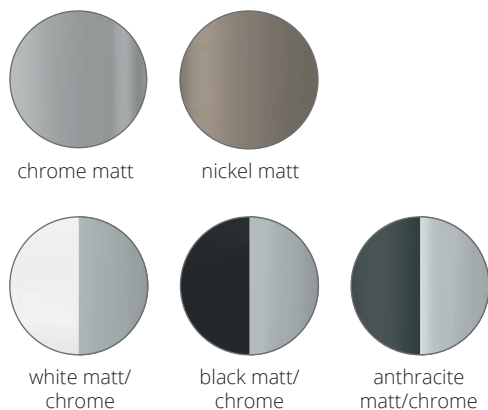

INDOOR

G9 Fassung

450 mm L 2 Köpfe/heads	850 mm L 3 Köpfe/heads	1.050 mm L 4 Köpfe/heads	1.250 mm L 4 Köpfe/heads	Gehäuse body
8-6284021-H	8-6288031-H	8-62810041-H	8-62812041-H	chrome matt
8-6284022-H	8-6288032-H	8-62810042-H	8-62812042-H	chrome
8-6284023-H	8-6288033-H	8-62810043-H	8-62812043-H	nickel matt
8-6284022-H-22	8-6288032-H-22	8-62810042-H-22	8-62812042-H-22	white matt/chrome
8-6284022-H-02	8-6288032-H-02	8-62810042-H-02	8-62812042-H-02	black matt/chrome
8-6284022-H-23	8-6288032-H-23	8-62810042-H-23	8-62812042-H-23	anthracite matt/chr.

Farbig gepulverter Lichtbalken auf Anfrage. Color powdered metal rail on request.

- ▶ Ohne Zubehör. Bestell-Artikelnummern für Linse, Glas, Farbfilter und die Konfigurationsempfehlung (2) auf der Einklappseite!
- ▶ Without accessories: Order item-no. for lens, glass, color filter and the recommended Configuration (2) are on the fold-in page!

G9 max. 33W ECO, optional LED Retrofit
 G9 max. 33W ECO, LED Retrofit optional

Leuchtmittelempfehlung: LED max. 3W/300lm/2.700K/dimmbar **G** Art. Nr. 8-205
 bulb recommendation: LED max. 3W/300lm/2.700K/dimmable **G** Item No. 8-205

LED

450 mm L 2 Köpfe/heads G 4 x 8W, ~2.700k, ~2.400lm	850 mm L 3 Köpfe/heads G 6 x 8W, ~2.700k, ~3.600lm	1.050 mm L 4 Köpfe/heads G 8 x 8W, ~2.700k, ~4.800lm	1.250 mm L 4 Köpfe/heads G 8 x 8W, ~2.700k, ~4.800lm	Gehäuse body
8-6284021	8-6288031	8-62810041	8-62812041	chrome matt
8-6284022	8-6288032	8-62810042	8-62812042	chrome
8-6284023	8-6288033	8-62810043	8-62812043	nickel matt
8-6284022-22	8-6288032-22	8-62810042-22	8-62812042-22	white matt/chrome
8-6284022-02	8-6288032-02	8-62810042-02	8-62812042-02	black matt/chrome
8-6284022-23	8-6288032-23	8-62810042-23	8-62812042-23	anthracite matt/chr.

Farbig gepulverter Lichtbalken auf Anfrage. Color powdered metal rail on request.

- ▶ Ohne Zubehör. Bestell-Artikelnummern für Linse, Glas, Farbfilter und die Konfigurationsempfehlung (2) auf der Einklappseite!
- ▶ Without accessories: Order item-no. for lens, glass, color filter and the recommended Configuration (2) are on the fold-in page!

Sonderanfertigung:
 Art-Nr. 8-600 Kürzung auf Maß
 Item No. 8-600 Customized lengths

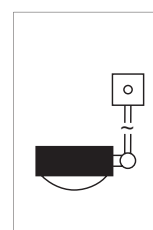
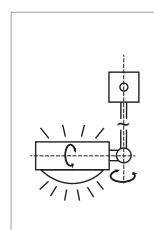
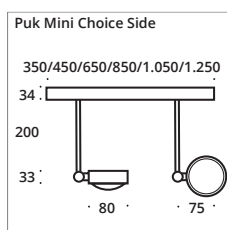

□ Chrom Teile/
chrome parts
■ Gepulverte Teile/
powder-coating





Puk Maxx Choice Side Ø 120

Deckenleuchte, Hochvolt LED Power oder Hochvolt Halogen, dimmbar. Der Lichtbalken ist bestückt mit dreh- und schwenkbaren Puk Maxx Side Leuchten. Zur Direktmontage an der Decke.

Ceiling lamp, high voltage LED power or high voltage halogen, dimmable. The light bar is equipped with rotatable and swivelling Puk Maxx Choice Side luminaires. For direct ceiling mounting.

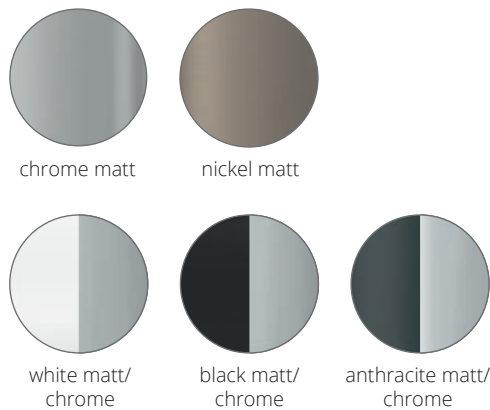

INDOOR

G9 Fassung

450 mm L 2 Köpfe/heads	850 mm L 3 Köpfe/heads	1.050 mm L 4 Köpfe/heads	1.250 mm L 4 Köpfe/heads	Gehäuse body
8-6584021-H	8-6588031-H	8-65810041-H	8-65812041-H	chrome matt
8-6584022-H	8-6588032-H	8-65810042-H	8-65812042-H	chrome
8-6584023-H	8-6588033-H	8-65810043-H	8-65812043-H	nickel matt
8-6584022-H-22	8-6588032-H-22	8-65810042-H-22	8-65812042-H-22	white matt/chrome
8-6584022-H-02	8-6588032-H-02	8-65810042-H-02	8-65812042-H-02	black matt/chrome
8-6584022-H-23	8-6588032-H-23	8-65810042-H-23	8-65812042-H-23	anthracite matt/chr.

Farbig gepulverter Lichtbalken auf Anfrage. Color powdered metal rail on request.

- ▶ Ohne Zubehör. Bestell-Artikelnummern für Linse, Glas, Farbfilter und die Konfigurationsempfehlung (2) auf der Einklappseite!
- ▶ Without accessories: Order item-no. for lens, glass, color filter and the recommended Configuration (2) are on the fold-in page!

- 💡 G9 max. 33W ECO, optional LED Retrofit
- 💡 G9 max. 33W ECO, LED Retrofit optional

- 💡 Leuchtmittelempfehlung: LED max. 3W/300lm/2.700K/dimmbar **G** Art. Nr. 8-205
- 💡 bulb recommendation: LED max. 3W/300lm/2.700K/dimmable **G** Item No. 8-205

LED

450 mm L 2 Köpfe/heads G 4 x 12W, ~2.700k, ~3.600lm	850 mm L 3 Köpfe/heads G 6 x 12W, ~2.700k, ~5.400lm	1.050 mm L 4 Köpfe/heads G 8 x 12W, ~2.700k, ~7.200lm	1.250 mm L 4 Köpfe/heads G 8 x 12W, ~2.700k, ~7.200lm	Gehäuse body
8-6584021	8-6588031	8-65810041	8-65812041	chrome matt
8-6584022	8-6588032	8-65810042	8-65812042	chrome
8-6584023	8-6588033	8-65810043	8-65812043	nickel matt
8-6584022-22	8-6588032-22	8-65810042-22	8-65812042-22	white matt/chrome
8-6584022-02	8-6588032-02	8-65810042-02	8-65812042-02	black matt/chrome
8-6584022-23	8-6588032-23	8-65810042-23	8-65812042-23	anthracite matt/chr.

Farbig gepulverter Lichtbalken auf Anfrage. Color powdered metal rail on request.

- ▶ Ohne Zubehör. Bestell-Artikelnummern für Linse, Glas, Farbfilter und die Konfigurationsempfehlung (2) auf der Einklappseite!
- ▶ Without accessories: Order item-no. for lens, glass, color filter and the recommended Configuration (2) are on the fold-in page!

Sonderanfertigung:
Art-Nr. 8-600 Kürzung auf Maß
Item No. 8-600 Customized lengths

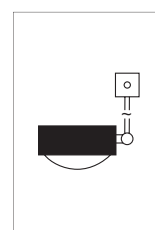
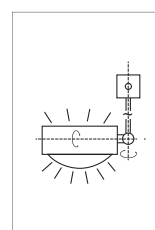
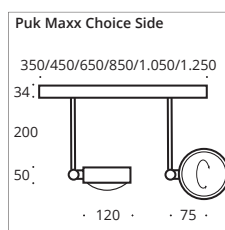

☐ Chrom Teile/
chrome parts
■ Gepulverte Teile/
powder-coating





Paxx ø 150

Diese puristisch moderne LED Deckenleuchte in Bauhaus inspiriertem Design ist ein wahrer Hingucker. Die 150mm Durchmesser Linse (optional ist auch ein mattes Glas für sanft gestreutes Licht erhältlich) wirkt freischwebend auf der Metallbasis. Mit ihren 15 Watt und 2.700 Kelvin bietet die Paxx eine gigantische Lichtausbeute und macht sie somit einsetzbar für den Privat- und für den Objektbereich. Eine Innovation dieser Leuchte ist die leichte und schnelle Montage durch ein einfaches Clip-System.

This puristic modern LED ceiling light in Bauhaus-inspired design is a real eye-catcher. The 150mm diameter lens (a matt glass for softly diffused light is also available as an option) appears free-floating on the metal base. With its 15 watts and 2,700 Kelvin, the Paxx offers a gigantic light output, making it suitable for both private and industrial use. An innovation of this luminaire is the easy and quick mounting by a simple clip system.

INDOOR



Paxx White Edition mit klarer Linse und weiß gepulverten Clips
Paxx white Edition with clear lens and white powder-coated clips



Paxx chrom
mit matter
Linse und
Clips in Nickel



Paxx schwarz
mit mattem
Glas und Clips
in Nickel



Black Edition
gepulverter Clip



White Edition
gepulverter Clip

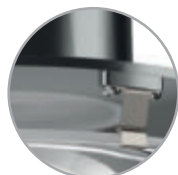

chrome matt
Clip in Nickel



chrome
Clip in Nickel

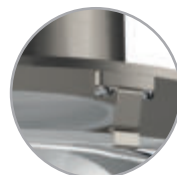

nickel matt
Clip in Nickel

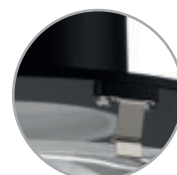

black matt
Clip in Nickel



white matt
Clip in Nickel

Paxx 2.700K LED G 15W, ~90CRI, ~1.500lm	ø x H ø x H in mm	Gehäuse body
● 7-90100-BE	150 x 57	black matt Black Edition
○ 7-90100-WE	150 x 57	white matt White Edition
● 7-90101	150 x 57	chrome matt/nickel
● 7-90102	150 x 57	chrome/nickel
● 7-90103	150 x 57	nickel matt
● 7-90102-02	150 x 57	black matt/nickel
● 7-90102-22	150 x 57	white matt/nickel
● 7-90102-23	150 x 57	anthracite matt/nickel

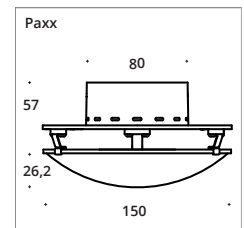

Art. Nr. item no.	Einsatz/Zubehör insert/equipment	Beschreibung description
2-5036 2-5036-s	Linse klar, clear lens Linse matt, frosted lens	Borosilikatglas klar, Borosilikatglass clear Borosilikatglas einseitig mattiert, Borosilikatglass frosted on one side
2-5037	Glas matt, frosted glass	Borosilikatglas beidseitig mattiert, passt nicht unter Linse Borosilikatglass frosted on both sides, doesn't fit under lens

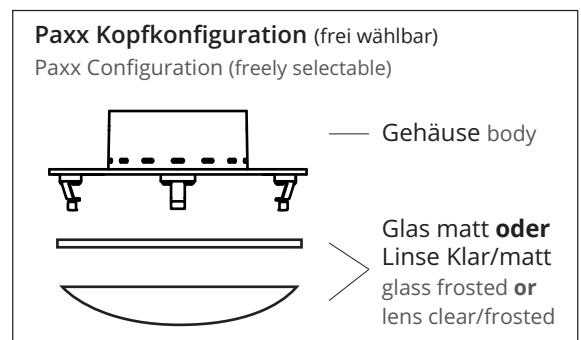





Allround ø 120/160/240

Diese Aufbauleuchte wurde für den Wand- und Deckeneinsatz konstruiert, dimmbar. Mit zwei kardanisch aufeinander abgestimmten Gelenken, lassen sich die LED Leuchtenköpfe um über 360 Grad drehen. Mit drei Leuchtenkopfdurchmessern (ø120mm/8W/920lm, ø160mm/12W/1300lm, ø240mm/16W/1600lm, durchgängig 2700k), sind die Leuchten für viele Anwendungen im Privat- oder Objektbereich planbar.

This surface-mounted luminaire was designed for wall and ceiling use, dimmable. With two gimbal-mounted joints, the LED luminaire heads can be rotated through more than 360 degrees. With three luminaire head diameters (ø120mm/8W/920lm, ø160mm/12W/1300lm, ø240mm/16W/1600lm, 2700k throughout all models), the luminaires can be integrated for many applications in the residential and project sector.

INDOOR

Allround in Bewegung (Wandbefestigung) Allround in motion (wall mounting)



Allround in Bewegung (Deckenbefestigung) Allround in motion (ceiling mounting)



chrome

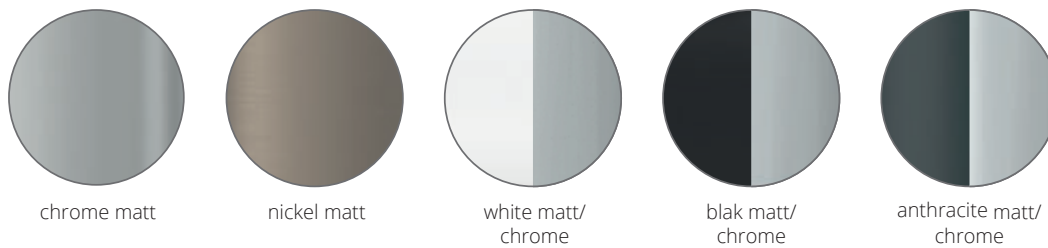

chrome matt

nickel matt

white matt/
chrome

black matt/
chrome

anthracite matt/
chrome

□ Chrom Teile/
chrome parts
■ Gepulverte Teile/
powder-coating

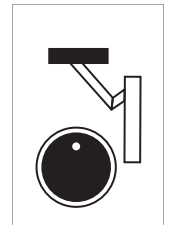

Allround 120 mm ø	Allround 160 mm ø	Allround 240 mm ø	Gehäuse body
LED: G 8 Watt, ~2.700k ~920 lm	LED: G 12 Watt, ~2.700k ~1.300 lm	LED: G 16 Watt, ~2.700k ~1.600 lm	
● 7-2201211 ● 7-2201212 ● 7-2201213 ● 7-2201212-22 ● 7-2201212-02 ● 7-2201212-23	● 7-2201611 ● 7-2201612 ● 7-2201613 ● 7-2201612-22 ● 7-2201612-02 ● 7-2201612-23	● 7-2202411 ● 7-2202412 ● 7-2202413 ● 7-2202412-22 ● 7-2202412-02 ● 7-2202412-23	chrome matt chrome nickel matt white matt/chrome black matt/chrome anthracite matt/chr.

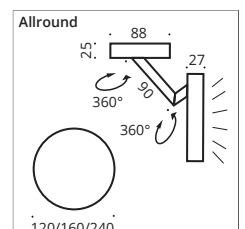
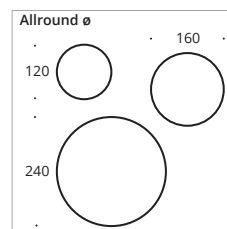





Allround Flat \varnothing 120/160/240

Diese flache LED Aufbauleuchte wurde für den Deckeneinsatz konstruiert, dimmbar. Mit drei Leuchtenkopfdurchmessern (\varnothing 120mm/8W/920lm, \varnothing 160mm/12W/1300lm, \varnothing 240mm/16W/1600lm, durchgängig 2700k), lassen sich die Leuchten für viele Anwendungen im Privat- oder Objektbereich einplanen.

This flat surface-mounted LED luminaire was designed for wall and ceiling use, dimmable. With three luminaire head diameters (\varnothing 120mm/8W/920lm, \varnothing 160mm/12W/1300lm, \varnothing 240mm/16W/1600lm, 2700k throughout all models), the luminaires can be planned for many applications in the private and contract sector.

INDOOR

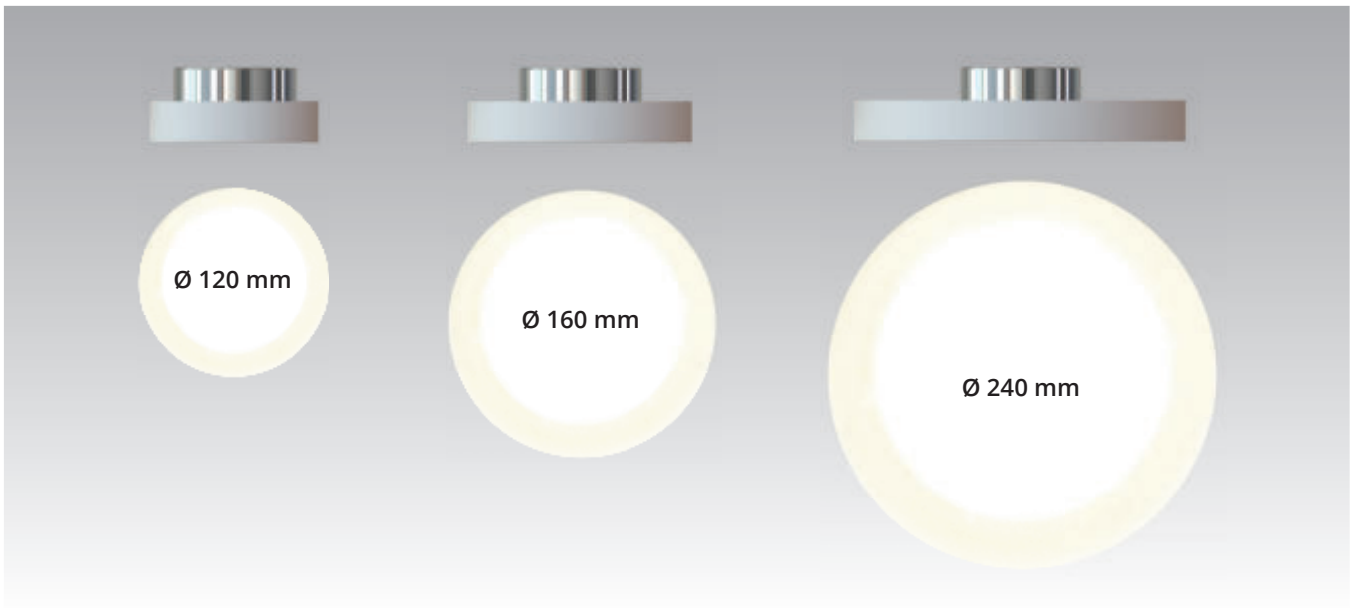

Allround 120 mm \varnothing	Allround 160 mm \varnothing	Allround 240 mm \varnothing	Gehäuse body
LED: G 8 Watt, ~2.700k ~920 lm	LED: G 12 Watt, ~2.700k ~1.300 lm	LED: G 16 Watt, ~2.700k ~1.600 lm	
<ul style="list-style-type: none"> ● 7-2221211 ● 7-2221212 ● 7-2221213 ● 7-2221212-22 ● 7-2221212-02 ● 7-2221212-23 	<ul style="list-style-type: none"> ● 7-2221611 ● 7-2221612 ● 7-2221613 ● 7-2221612-22 ● 7-2221612-02 ● 7-2221612-23 	<ul style="list-style-type: none"> ● 7-2222411 ● 7-2222412 ● 7-2222413 ● 7-2222412-22 ● 7-2222412-02 ● 7-2222412-23 	<ul style="list-style-type: none"> chrome matt chrome nickel matt white matt/chrome black matt/chrome anthracite matt/chr.

BC (s.S 6-7/s.p. 6-7)

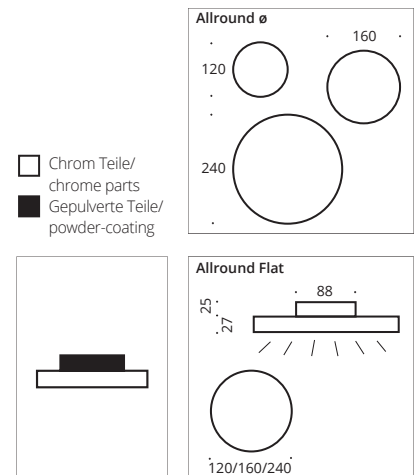





Foxx Round \varnothing 200/300/400/500

Mit 20 mm ist die Round eine sensationell flache LED Deckenleuchte in den Durchmessern 200/300/400/500 mm. Als Auf- oder Einbauleuchte passt sie sich allen Stilrichtungen an. Mit der eingesetzten LED Hochvolttechnik heißt es nur noch »plug and light«. Auch als Outdoor Variante erhältlich (IP44).

With an unbelievable height of 20 mm the slim LED lamp can be mounted on ceilings. Diameter are available in 200/300/400/500 mm. As built-in or surface mounted luminaire for all kind of lighting requirements. With its high power LED assembly is as easy as possible. "Plug and light". Also available for Outdoor (IP44) areas.

INDOOR

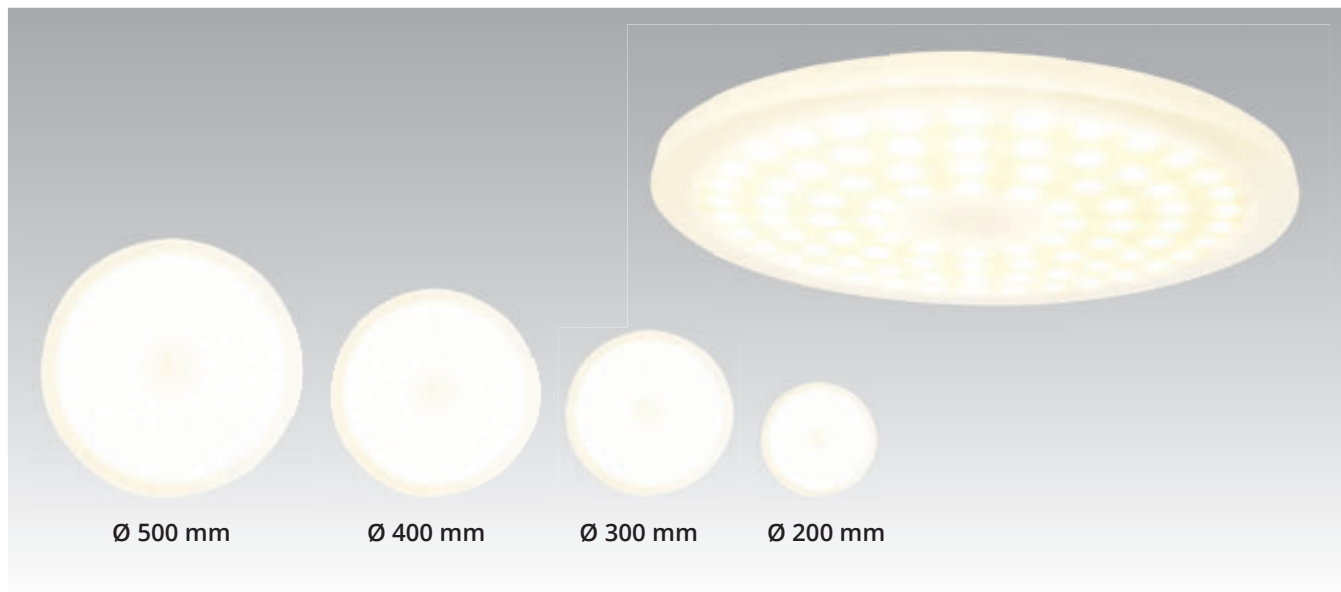

Foxx Round 200/300/400/500 Wall & Ceiling (Aufbauleuchte/surface mounting)

Round 200 mm \varnothing	Round 300 mm \varnothing	Round 400 mm \varnothing	Round 500 mm \varnothing	Gehäuse body
LED: G 10 Watt, ~2.700k ~700lm	LED: G 14 Watt, ~2.700k ~1.260lm	LED: G 22 Watt, ~2.700k ~1.980lm	LED: G 33 Watt, ~2.700k ~2.970lm	
7-46320010	7-46330010	7-46340010	7-46350010	alueloxiert/ frosted solid acrylic

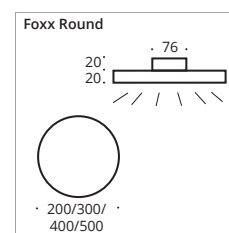

Foxx Round 200/300/400/500 Fit In (Einbauleuchte/recessed fitting)

Round 200 mm \varnothing	Round 300 mm \varnothing	Round 400 mm \varnothing	Round 500 mm \varnothing	Gehäuse body
LED: G 10 Watt, ~2.700k ~700lm	LED: G 14 Watt, ~2.700k ~1.260lm	LED: G 22 Watt, ~2.700k ~1.980lm	LED: G 33 Watt, ~2.700k ~2.970lm	
7-46420010	7-46430010	7-46440010	7-46450010	alueloxiert/ frosted solid acrylic

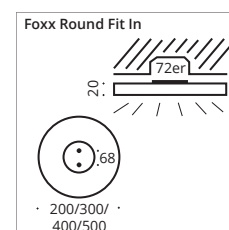





Foxx Cube ø 200/300/400/500

Mit 20 mm ist die Cube eine sensationell flache LED Deckenleuchte in den Durchmessern 200/300/400/500 mm. Als Auf- oder Einbauleuchte passt sie sich allen Stilrichtungen an. Mit der eingesetzten LED Hochvolttechnik heißt es nur noch »plug and light«. Auch als Outdoor Variante erhältlich (IP44).

With an unbelievable height of 20 mm the slim LED lamp can be mounted on ceilings. Diameter are available in 200/300/400/500 mm. As built-in or surface mounted luminaire for all kind of lighting requirements. With its high power LED assembly is as easy as possible. "Plug and light". Also available for Outdoor (IP44) areas.

INDOOR

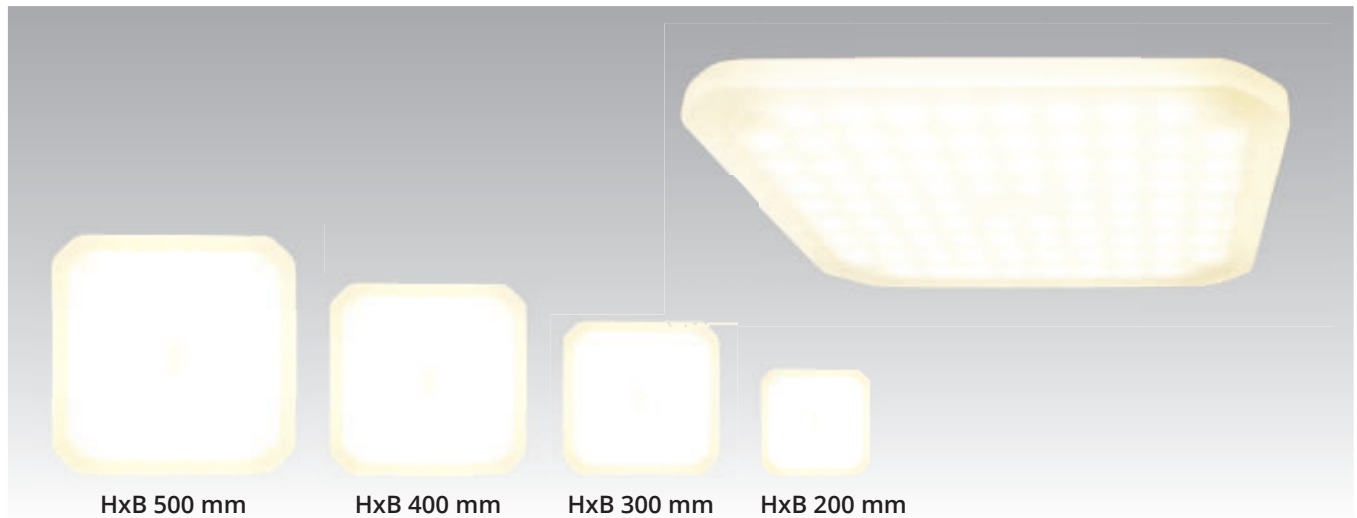

Foxx Cube 200/300/400/500

Wall & Ceiling (Aufbauleuchte/surface mounting)

Cube	Cube	Cube	Cube	Gehäuse
200 x 200 mm	300 x 300 mm	400 x 400 mm	500 x 500 mm	body
LED: G 10 Watt, ~2.700k ~700lm	LED: G 14 Watt, ~2.700k ~1.260lm	LED: G 22 Watt, ~2.700k ~1.980lm	LED: G 33 Watt, ~2.700k ~2.970lm	
7-46120010	7-46130010	7-46140010	7-46150010	alueloxiert/ frosted solid acrylic

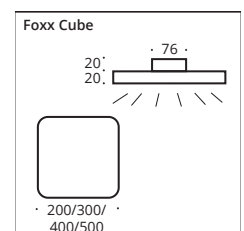

Foxx Cube 200/300/400/500

Fit In (Einbauleuchte/recessed fitting)

Cube	Cube	Cube	Cube	Gehäuse
200 x 200 mm	300 x 300 mm	400 x 400 mm	500 x 500 mm	body
LED: G 10 Watt, ~2.700k ~700lm	LED: G 14 Watt, ~2.700k ~1.260lm	LED: G 22 Watt, ~2.700k ~1.980lm	LED: G 33 Watt, ~2.700k ~2.970lm	
7-46220010	7-46230010	7-46240010	7-46250010	alueloxiert/ frosted solid acrylic

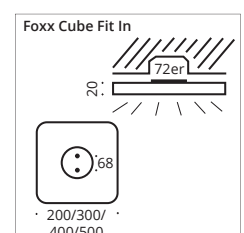





Sun ø 90/130/210

Der Leuchtenkopf der LED Deckenleuchte Sun Ceiling lässt sich in alle Richtungen über ein Kugelgelenk schwenken. Sie ist in den Durchmessern 90/130/210 mm als Up- oder Downlight wählbar. Ob direkt oder Indirekt, lässt sich das Licht dorthin lenken, wo es benötigt wird. Auch als Outdoorleuchte erhältlich in IP44.

The luminaire head of the Sun Ceiling LED luminaires can be swivelled in all directions via a ball joint. It is available in the diameters 90/130/210 mm as uplight or downlight. Whether direct or indirect, the light can be directed to where it is needed. Also available as an outdoor version (IP44).

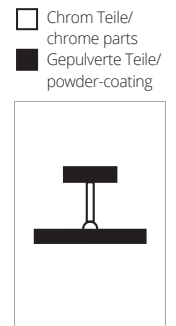
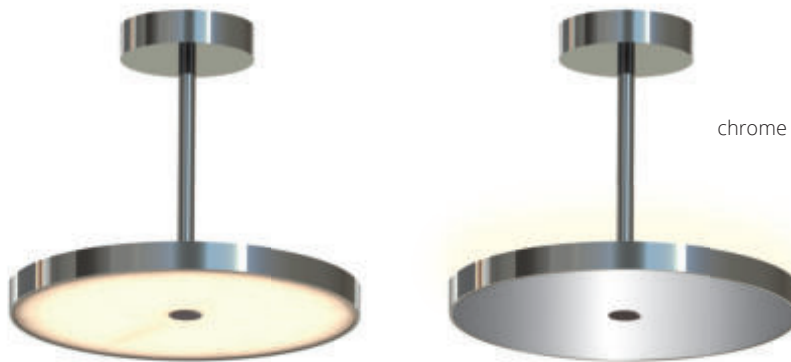
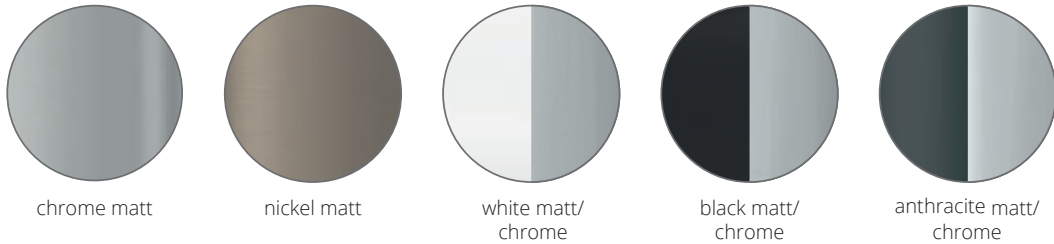

Indoor Sun – Up Light

Up Light	Up Light	Up Light	Gehäuse body
Kopf/head: ø 90 mm Baldachin: ø 65 mm LED: G 8 Watt, ~2.700k, ~920 lm	Kopf/head: ø 130 mm Baldachin: ø 65 mm LED: G 12 Watt, ~2.700k, ~1.300 lm	Kopf/head: ø 210 mm Baldachin: ø 80 mm LED: G 16 Watt, ~2.700k, ~1.600 lm	
<ul style="list-style-type: none"> ● 7-3259011 ● 7-3259012 ● 7-3259013 ● 7-3259012-22 ● 7-3259012-02 ● 7-3259012-23 	<ul style="list-style-type: none"> ● 7-32513011 ● 7-32513012 ● 7-32513013 ● 7-32513012-22 ● 7-32513012-02 ● 7-32513012-23 	<ul style="list-style-type: none"> ● 7-32521011 ● 7-32521012 ● 7-32521013 ● 7-32521012-22 ● 7-32521012-02 ● 7-32521012-23 	<ul style="list-style-type: none"> ● chrome matt ● chrome ● nickel matt ● white matt/chrome ● black matt/chrome ● anthracite matt/chr.

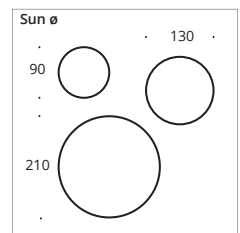

Indoor Sun – Down Light

Down Light	Down Light	Down Light	Gehäuse body
Kopf/head: ø 90 mm Baldachin: ø 65 mm LED: G 8 Watt, ~2.700k, ~920 lm	Kopf/head: ø 130 mm Baldachin: ø 65 mm LED: G 12 Watt, ~2.700k, ~1.300 lm	Kopf/head: ø 210 mm Baldachin: ø 80 mm LED: G 16 Watt, ~2.700k, ~1.600 lm	
<ul style="list-style-type: none"> ● 7-3269011 ● 7-3269012 ● 7-3269013 ● 7-3269012-22 ● 7-3269012-02 ● 7-3269012-23 	<ul style="list-style-type: none"> ● 7-32613011 ● 7-32613012 ● 7-32613013 ● 7-32613012-22 ● 7-32613012-02 ● 7-32613012-23 	<ul style="list-style-type: none"> ● 7-32621011 ● 7-32621012 ● 7-32621013 ● 7-32621012-22 ● 7-32621012-02 ● 7-32621012-23 	<ul style="list-style-type: none"> ● chrome matt ● chrome ● nickel matt ● white matt/chrome ● black matt/chrome ● anthracite matt/chr.

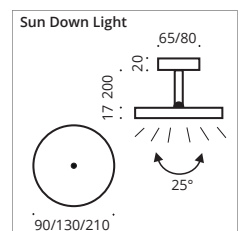
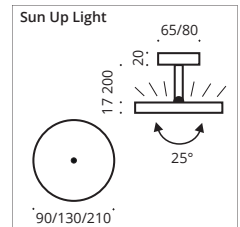



Sun Ceiling Choice downlight



Sun Ceiling Choice \varnothing 90/130/210 downlight

Lichtbalken für Direktmontage an der Decke. Bestückt mit Sun Ceiling Leuchten, Kopfdurchmesser 90, 130 oder 210 mm. Deckenleuchten aus der Top Light Serie.

Light bar for direct mounting on the ceiling. Equipped with Sun Ceiling luminaires, diameter 90, 130 or 210 mm. Ceiling light from the Top Light series.

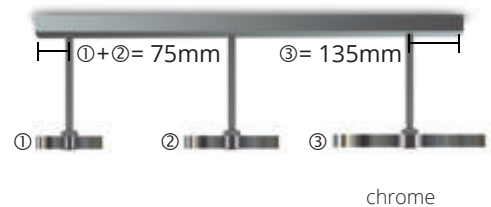
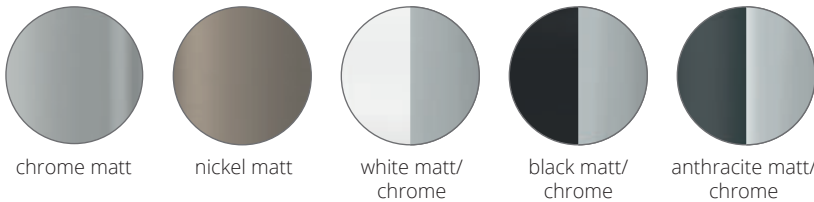

INDOOR

Sun Ceiling \varnothing 90 mm downlight

450 mm L 2 Köpfe/heads LED: G 16W ~1.840lm ~2.700k	650 mm L 3 Köpfe/heads LED: G 24W ~2.760lm ~2.700k	1.050 mm L 4 Köpfe/heads LED: G 32W ~3.680lm ~2.700k	1.250 mm L 4 Köpfe/heads LED: G 32W ~3.680lm ~2.700k	Gehäuse body
8-72904021	8-72906031	8-729010041	8-729012041	chrome matt
8-72904022	8-72906032	8-729010042	8-729012042	chrome
8-72904023	8-72906033	8-729010043	8-729012043	nickel matt
8-72904022-22	8-72906032-22	8-729010042-22	8-729012042-22	white matt/chr.
8-72904022-02	8-72906032-02	8-729010042-02	8-729012042-02	black matt/chr.
8-72904022-23	8-72906032-23	8-729010042-23	8-729012042-23	anthracite matt/chr.

Farbig gepulverter Lichtbalken auf Anfrage. Color powdered metal rail on request.

Sun Ceiling \varnothing 130 mm downlight

450 mm L 2 Köpfe/heads LED: G 24W ~2.600lm ~2.700k	650 mm L 3 Köpfe/heads LED: G 36W ~3.900lm ~2.700k	1.050 mm L 4 Köpfe/heads LED: G 48W ~5.200lm ~2.700k	1.250 mm L 4 Köpfe/heads LED: G 48W ~5.200lm ~2.700k	Gehäuse body
8-721304021	8-721306031	8-7213010041	8-7213012041	chrome matt
8-721304022	8-721306032	8-7213010042	8-7213012042	chrome
8-721304023	8-721306033	8-7213010043	8-7213012043	nickel matt
8-721304022-22	8-721306032-22	8-7213010042-22	8-7213012042-22	white matt/chr.
8-721304022-02	8-721306032-02	8-7213010042-02	8-7213012042-02	black matt/chr.
8-721304022-23	8-721306032-23	8-7213010042-23	8-7213012042-23	anthracite matt/chr.

Farbig gepulverter Lichtbalken auf Anfrage. Color powdered metal rail on request.

Sun Ceiling \varnothing 210 mm downlight

850 mm L 2 Köpfe/heads LED: G 32W ~3.200lm ~2.700k	1.050 mm L 3 Köpfe/heads LED: G 48W ~4.800lm ~2.700k	1.250 mm L 3 Köpfe/heads LED: G 48W ~4.800lm ~2.700k	Gehäuse body
8-722108031	8-7221010041	8-7221012041	chrome matt
8-722108032	8-7221010042	8-7221012042	chrome
8-722108033	8-7221010043	8-7221012043	nickel matt
8-722108032-22	8-7221010042-22	8-7221012042-22	white matt/chr.
8-722108032-02	8-7221010042-02	8-7221012042-02	black matt/chr.
8-722108032-23	8-7221010042-23	8-7221012042-23	anthracite matt/chr.

Farbig gepulverter Lichtbalken auf Anfrage. Color powdered metal rail on request.

Sonderanfertigung:

Art-Nr. 8-600 Kürzung auf Maß

Item No. 8-600 Customized lengths

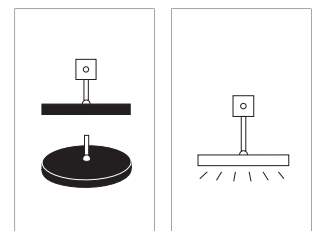
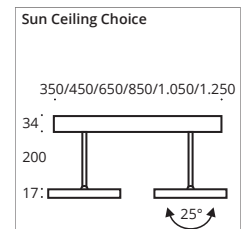

□ Chrom Teile/
chrome parts
■ Gepulverte Teile/
powder-coating



Sun Ceiling Choice uplight



Sun Ceiling Choice \varnothing 90/130/210 uplight

Lichtbalken für Direktmontage an der Decke. Bestückt mit Sun Ceiling Leuchten, Kopfdurchmesser 90, 130 oder 210 mm. Deckenleuchten aus der Top Light Serie.

Light bar for direct mounting on the ceiling. Equipped with Sun Ceiling luminaires, diameter 90, 130 or 210 mm. Ceiling light from the Top Light series.

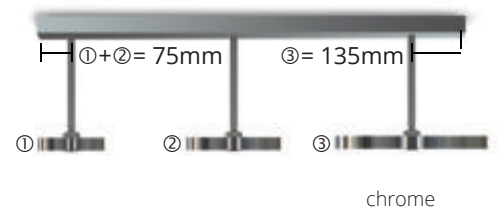
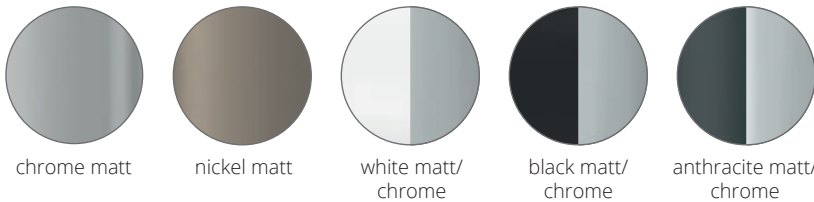

INDOOR

Sun Ceiling \varnothing 90 mm uplight

450 mm L 2 Köpfe/heads LED: G 16W ~1.840lm ~2.700k	650 mm L 3 Köpfe/heads LED: G 24W ~2.760lm ~2.700k	1.050 mm L 4 Köpfe/heads LED: G 32W ~3.680lm ~2.700k	1.250 mm L 4 Köpfe/heads LED: G 32W ~3.680lm ~2.700k	Gehäuse body
8-73904021	8-73906031	8-739010041	8-739012041	chrome matt
8-73904022	8-73906032	8-739010042	8-739012042	chrome
8-73904023	8-73906033	8-739010043	8-739012043	nickel matt
8-73904022-22	8-73906032-22	8-739010042-22	8-739012042-22	white matt/chr.
8-73904022-02	8-73906032-02	8-739010042-02	8-739012042-02	black matt/chr.
8-73904022-23	8-73906032-23	8-739010042-23	8-739012042-23	anthracite matt/chr.

Farbig gepulverter Lichtbalken auf Anfrage. Color powdered metal rail on request.

Sun Ceiling \varnothing 130 mm uplight

450 mm L 2 Köpfe/heads LED: G 24W ~2.600lm ~2.700k	650 mm L 3 Köpfe/heads LED: G 36W ~3.900lm ~2.700k	1.050 mm L 4 Köpfe/heads LED: G 48W ~5.200lm ~2.700k	1.250 mm L 4 Köpfe/heads LED: G 48W ~5.200lm ~2.700k	Gehäuse body
8-731304021	8-731306031	8-7313010041	8-7313012041	chrome matt
8-731304022	8-731306032	8-7313010042	8-7313012042	chrome
8-731304023	8-731306033	8-7313010043	8-7313012043	nickel matt
8-731304022-22	8-731306032-22	8-7313010042-22	8-7313012042-22	white matt/chr.
8-731304022-02	8-731306032-02	8-7313010042-02	8-7313012042-02	black matt/chr.
8-731304022-23	8-731306032-23	8-7313010042-23	8-7313012042-23	anthracite matt/chr.

Farbig gepulverter Lichtbalken auf Anfrage. Color powdered metal rail on request.

Sun Ceiling \varnothing 210 mm uplight

850 mm L 2 Köpfe/heads LED: G 32W ~3.200lm ~2.700k	1.050 mm L 3 Köpfe/heads LED: G 48W ~4.800lm ~2.700k	1.250 mm L 3 Köpfe/heads LED: G 48W ~4.800lm ~2.700k	Gehäuse body
8-732108031	8-7321010041	8-7321012041	chrome matt
8-732108032	8-7321010042	8-7321012042	chrome
8-732108033	8-7321010043	8-7321012043	nickel matt
8-732108032-22	8-7321010042-22	8-7321012042-22	white matt/chr.
8-732108032-02	8-7321010042-02	8-7321012042-02	black matt/chr.
8-732108032-23	8-7321010042-23	8-7321012042-23	anthracite matt/chr.

Farbig gepulverter Lichtbalken auf Anfrage. Color powdered metal on request.

Sonderanfertigung:

Art-Nr. 8-600 Kürzung auf Maß

Item No. 8-600 Customized lengths



Chrom Teile/
chrome parts
 Gepulverte Teile/
powder-coating

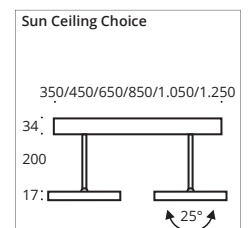
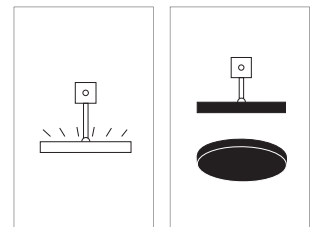





Only Choice Ceiling

Geradlinige LED Leuchte für die Direktmontage mit Prismen-
diffusor. Für den Objekt- und Privatbereich der Officeanwen-
dung.

Linear LED luminaire for direct mounting with prismatic dif-
fuser. For project and residential use.

INDOOR

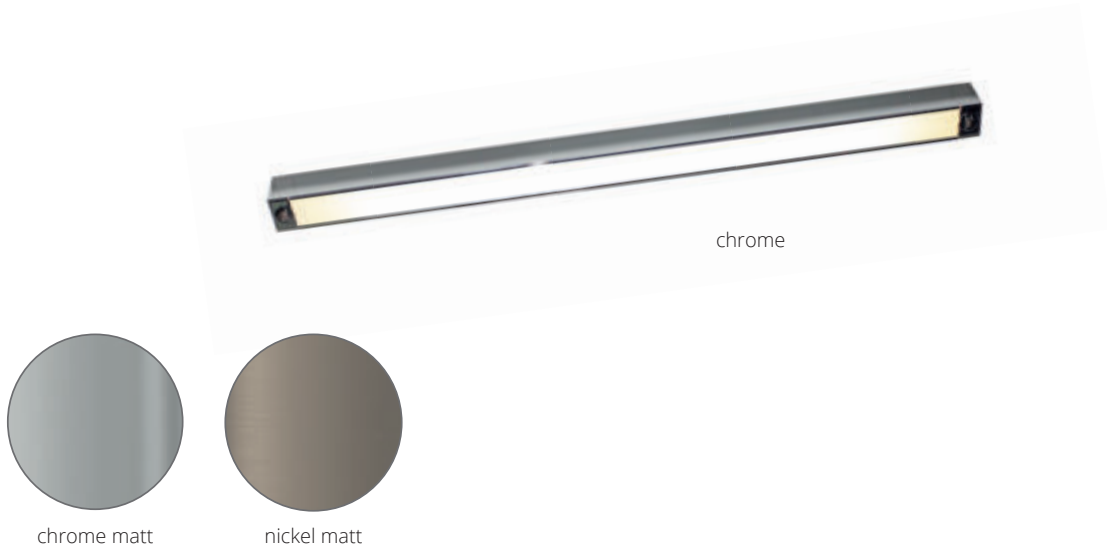

Only Choice Direktmontage

350 mm L	600 mm L	800 mm L	1.250 mm L	Gehäuse body
LED: G 9W, ~720lm, ~3.000k	LED: G 13,5W, ~1080lm, ~3.000k	LED: G 22,5W, ~1800lm, ~3.000k	LED: G 36W, ~2880lm, ~3.000k	
8-601351	8-601651	8-601951	8-6011251	chrome matt
8-601352	8-601652	8-601952	8-6011252	chrome
8-601353	8-601653	8-601953	8-6011253	nickel matt

Farbig gepulverter Lichtbalken auf Anfrage. Color powdered metal rail on request.

Bitte hinter die Art.-Nr. den Buchstaben (A-C) der gewünschten Deckenvariante hängen.
Durch Versetzen der Endkappen ist jede Variante montierbar.

Please attach the character (A-C) to the item no. of the ceiling variant you have chosen.
With turning the endpieces the lamp can be mounted in every position.



Sonderanfertigung:

Art-Nr. 8-600 Kürzung auf Maß

Item No. 8-600 Customized lengths

Montagevarianten:

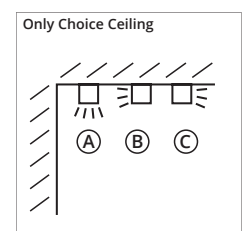
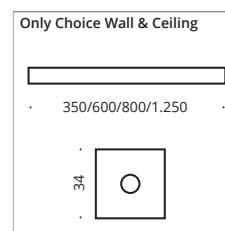





Dela

Deckenleuchten für einen idealen Einsatz in Fluren und Bädern. Gefertigt aus Mattglas bietet sie ein weiches Rundumlicht. Erhältlich mit verschiedenen Fassungen.

Ceiling lights for ideal use in hallways and bathrooms. Made of frosted glass, it offers a soft all-round light. Available in different versions.

Reflektor "Option", baffle "option"



Richtungsweisend:

Aluminium-Hochleistungsreflektor, einfache Montage durch Einschub in den Glastubus.

Multi directional:

High performance baffle. Easy installation: slides into the tube.



Dela



Dela Short



Dela Short Spot mit Abdeckplatte/with cover panel

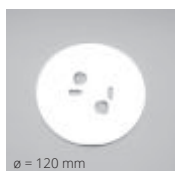

Abdeckplatte, passend für Dela und Dela-short/Spot, Sicht- und Hitzeschutz für Holzdecken und Hohlraum Dosen, superflach - nur 2 mm, verdeckte Montage.

Cover panel for Dela and Dela-short/Spot. Screen and heat protection for wooden ceilings and cavity outlets. Super flat - only 2 mm. For hidden mounting.

INDOOR

E27 Fassung	Art.Nr. item no.	B x H w x h in mm	Ausführung design
Dela	4-07651	65 x 180	satiniertes Glas frosted glass

E27 max. 42W, optional LED Retrofit
E27 max. 42W, LED Retrofit optional

Leuchtmittlempfehlung: LED max. 9W/800lm/2.700K **G** Art. Nr. 8-309
bulb recommendation: LED max. 9W/800Lm/2.700K **G** Item No. 8-309

G9 Fassung	Art.Nr. item no.	B x H w x h in mm	Ausführung design
Dela Short	4-06650	65 x 80	satiniertes Glas frosted glass

G9 max. 33W, optional LED Retrofit
G9 max. 33W, LED Retrofit optional

Leuchtmittlempfehlung: LED max. 3W/300lm/2.700K/dimmbar **G** Art. Nr. 8-205
bulb recommendation: LED max. 3W/300Lm/2.700K/dimmable **G** Item No. 8-205

GU10 Fassung	Art.Nr. item no.	B x H w x h in mm	Ausführung design
Dela Short Spot	7-06659	65 x 80	Deckenstrahler ceiling spotlight

GU10 max. 35W, optional LED Retrofit
GU10 max. 35W, LED Retrofit optional

Leuchtmittlempfehlung: LED max. 4W/230lm/2.700K **G** Art. Nr. 8-211
bulb recommendation: LED max. 4W/230Lm/2.700K **G** Item No. 8-211

Modell model	Art.Nr. item no.	Ausführung design
"Option"	9-200	Reflektor für Dela baffle for Dela
"Option"	9-201	Reflektor für Dela Short baffle for Dela Short
Abdeckplatte, verdeckte Montage hidden cover panel	9-12002 9-12009 9-12002-22 9-12002-02	chrome nickel matt white matt black matt

CE R LED C IP20 BC (s.S 6-7/s.p. 6-7)

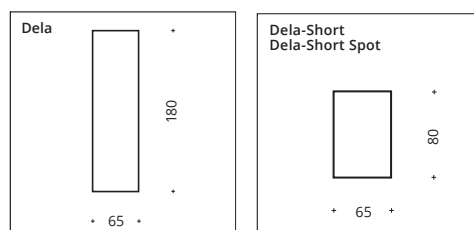





Dela Box

Deckenleuchten für einen idealen Einsatz in Fluren und Bädern. Gefertigt aus Mattglas bietet sie ein weiches Rundum-Licht. Erhältlich mit verschiedenen Fassungen. Aufbausockel wahlweise in chrom oder nickelmatt.

Ceiling lights for ideal use in hallways and bathrooms. Made of frosted glass, it offers a soft all-round light. Available in different versions. Mounting base alternatively in chrome or nickel matt design.



Dela Box Short Spot

Reflektor "Option", baffle "option"

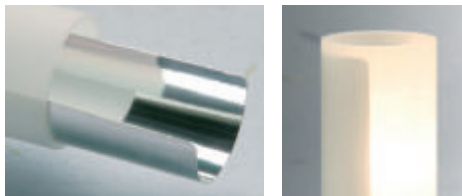

Richtungsweisend:

Aluminium-Hochleistungsreflektor, einfache Montage durch Einschub in den Glastubus.

Multi directional:

High performance baffle. Easy installation: slides into the tube.



Dela Box Short & Box

INDOOR

E27 Fassung	Art.Nr. item no.	Ausführung design
Dela Box	4-04651	nickel matt chrome
Short Spot	4-04652	chrome
"Option"	9-200	Reflektor, baffle
E27 max. 42W, optional LED Retrofit		
E27 max. 42W, LED Retrofit optional		
Leuchtmittelempfehlung: LED max.		
9W/800lm/2.700K Art. Nr. 8-309		
bulb recommendation: LED max.		
9W/800lm/2.700K Item No. 8-309		

G9 Fassung	Art.Nr. item no.	Ausführung design
Dela Box Short	4-05651	nickel matt chrome
Short Spot	4-05652	chrome
"Option"	9-201	Reflektor, baffle
G9 max. 33W, optional LED Retrofit		
G9 max. 33W, LED Retrofit optional		
Leuchtmittelempfehlung: LED max.		
3W/300lm/2.700K/dimmbar Art. Nr. 8-205		
bulb recommendation: LED max. 3W/300lm/2.700K/		
dimmable Item No. 8-205		

GU10 Fassung	Art.Nr. item no.	Ausführung design
Dela Box	4-05658	nickel matt chrome
Short Spot	4-05659	chrome
GU10 max. 35W, optional LED Retrofit		
GU10 max. 35W, LED Retrofit optional		
Leuchtmittelempfehlung: LED max.		
4W/230lm/2.700K Art. Nr. 8-211		
bulb recommendation: LED max. 4W/230Lm/2.700K		
Item No. 8-211		

LED	Art.Nr. item no.	Ausführung design
4W, ~390lm, ~3.000k		
Dela Box LED	4-04651-LED	nickel matt chrome
Short Spot LED	4-04652-LED	chrome
Dela Box Short LED	4-05651-LED	nickel matt chrome
Short Spot LED	4-05652-LED	chrome

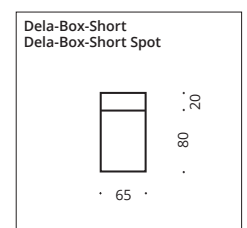
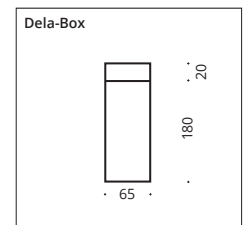





Quadro

Deckenleuchten für einen idealen Einsatz in Fluren und Bädern. Gefertigt aus Mattglas bietet sie ein weiches Rundum-Licht. Erhältlich mit verschiedenen Fassungen.

Ceiling lights for ideal use in hallways and bathrooms. Made of frosted glass, it offers a soft all-round light. Available in different versions.

INDOOR



Quadro Short & Quadro



Quadro Short Spot

E27 Fassung	Art.Nr. item no.	Ausführung design
Quadro	4-07621	satinieretes Glas, frosted glass

- E27 max. 42W, optional LED Retrofit
- E27 max. 42W, LED Retrofit optional
- Leuchtmittlempfehlung: LED max. 9W/800lm/2.700K **G** Art. Nr. 8-309
- bulb recommendation: LED max. 9W/800Lm/2.700K **G** Item No. 8-309

G9 Fassung	Art.Nr. item no.	Ausführung design
Quadro Short	4-06620	satinieretes Glas, frosted glass

- G9 max. 33W, optional LED Retrofit
- G9 max. 33W, LED Retrofit optional
- Leuchtmittlempfehlung: LED max. 3W/300lm/2.700K/dimmbar **G** Art. Nr. 8-205
- bulb recommendation: LED max. 3W/300Lm/2.700K/dimmable **G** Item No. 8-205

GU10 Fassung	Art.Nr. item no.	Ausführung design
Quadro Short Spot	7-06629	satinieretes Glas, frosted glass

- GU10 max. 35W, optional LED Retrofit
- GU10 max. 35W, LED Retrofit optional
- Leuchtmittlempfehlung: LED max. 4W/230lm/2.700K **G** Art. Nr. 8-211
- bulb recommendation: LED max. 4W/230Lm/2.700K **G** Item No. 8-211

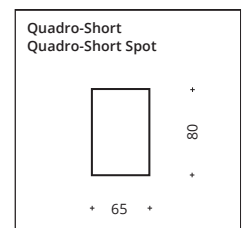
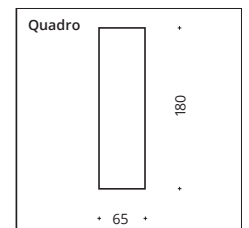





Quadro Box

Deckenleuchten für einen idealen Einsatz in Fluren und Bädern. Gefertigt aus Mattglas bietet sie ein weiches Rundum-Licht. Erhältlich mit verschiedenen Fassungen. Aufbausockel wahlweise in chrom oder nickelmatt.

Ceiling lights for ideal use in hallways and bathrooms. Made of frosted glass, it offers a soft all-round light. Available in different versions. Mounting base alternatively in chrome or nickel matt design.



Quadro Box Short Spot



Quadro Box & Quadro Box Short

INDOOR

E27 Fassung	Art.Nr. item no.	Ausführung design
● Quadro Box 80W, ~1.800lm	4-04621 4-04622	nickel matt chrome
<ul style="list-style-type: none"> E27 max. 42W, optional LED Retrofit E27 max. 42W, LED Retrofit optional Leuchtmittlempfehlung: LED max. 9W/800lm/2.700K G Art. Nr. 8-309 bulb recommendation: LED max. 9W/800Lm/2.700K G Item No. 8-309 		

G9 Fassung	Art.Nr. item no.	Ausführung design
● Quadro Box Short	4-05621 4-05622	nickel matt chrome
<ul style="list-style-type: none"> G9 max. 33W, optional LED Retrofit G9 max. 33W, LED Retrofit optional Leuchtmittlempfehlung: LED max. 3W/300lm/2.700K/dimmbar G Art. Nr. 8-205 bulb recommendation: LED max. 3W/300Lm/2.700K/dimmable G Item No. 8-205 		

GU10 Fassung	Art.Nr. item no.	Ausführung design
● Quadro Box ● Short Spot	4-05628 4-05629	nickel matt chrome
<ul style="list-style-type: none"> GU10 max. 35W, optional LED Retrofit GU10 max. 35W, LED Retrofit optional Leuchtmittlempfehlung: LED max. 4W/230lm/2.700K G Art. Nr. 8-211 bulb recommendation: LED max. 4W/230Lm/2.700K G Item No. 8-211 		

LED	Art.Nr. item no.	Ausführung design
G 4W, ~390lm ~2.800k		
● Quadro Box ● LED	4-04621-LED 4-04622-LED	nickel matt chrome
● Quadro Box ● Short LED	4-05621-LED 4-05622-LED	nickel matt chrome

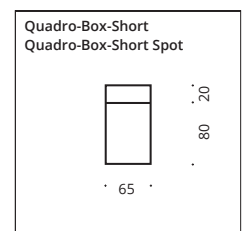
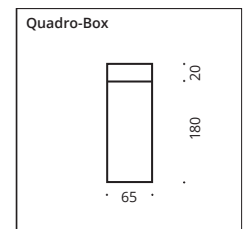

BC (s.S 6-7/s.p. 6-7)





Puk Mini Inside

Deckeneinbauleuchte als ein- oder zweiflammige Leuchte lieferbar. Kopf dreh- und schwenkbar. Durch Herausziehen des Leuchtenkopfes voller Lichtaustritt bei maximaler Ausschwenkung.

Recessed ceiling luminaire available as single- or double-lamp version. Head can be rotated and swivelled. by pulling out the luminaire head, full light emission at maximum swivel.

INDOOR

Puk Mini Inside - ☉

Puk Inside LED G 8W, ~600lm, ~2.700k	Puk Inside G9 Fassung	∅ ∅ in mm	Gehäuse body
7-71001	7-71001-H	158	chrome matt
7-71002	7-71002-H	158	chrome
7-71003	7-71003-H	158	nickel matt
7-71002-22	7-71002-H-22	158	white matt/chr.
7-71002-02	7-71002-H-02	158	black matt/chr.
7-71002-23	7-71002-H-23	158	anthracite matt/chr.

▶ Ohne Zubehör. Bestell-Artikelnummern für Linse, Glas, Farbfilter und die Konfigurationsempfehlung (2) auf der Einklappseite!

▶ Without accessories: Order item-no. for lens, glass, color filter and the recommended Configuration (2) are on the fold-in page!

G9 max. 33W, optional LED Retrofit
 G9 max. 33W, LED Retrofit optional

Leuchtmittlempfehlung: LED max. 3W/300lm/2.700K/dimmbar **G** Art. Nr. 8-205
 bulb recommendation: LED max. 3W/300Lm/2.700K/dimmable **G** Item No. 8-205

Puk Mini Inside - ☉

Puk Inside LED G 8W, ~600lm, ~2.700k	Puk Inside G9 Fassung	L x B L x B in mm	Gehäuse body
7-72001	7-72001-H	158 x 158	chrome matt
7-72002	7-72002-H	158 x 158	chrome
7-72003	7-72003-H	158 x 158	nickel matt
7-72002-22	7-72002-H-22	158 x 158	white matt/chr.
7-72002-02	7-72002-H-02	158 x 158	black matt/chr.
7-72002-23	7-72002-H-23	158 x 158	anthracite matt/chr.

▶ Ohne Zubehör. Bestell-Artikelnummern für Linse, Glas, Farbfilter und die Konfigurationsempfehlung (2) auf der Einklappseite!

▶ Without accessories: Order item-no. for lens, glass, color filter and the recommended Configuration (2) are on the fold-in page!

G9 max. 33W, optional LED Retrofit
 G9 max. 33W, LED Retrofit optional

Leuchtmittlempfehlung: LED max. 3W/300lm/2.700K/dimmbar **G** Art. Nr. 8-205
 bulb recommendation: LED max. 3W/300Lm/2.700K/dimmable **G** Item No. 8-205

Puk Mini Inside - ☉☉

Puk Inside Twin LED G 2 x 8W, ~1.200lm, ~2.700k	Puk Inside G9 Fassung	L x B L x B in mm	Gehäuse body
7-73001	7-73001-H	283 x 158	chrome matt
7-73002	7-73002-H	283 x 158	chrome
7-73003	7-73003-H	283 x 158	nickel matt
7-73002-22	7-73002-H-22	283 x 158	white matt/chr.
7-73002-02	7-73002-H-02	283 x 158	black matt/chr.
7-73002-23	7-73002-H-23	283 x 158	anthracite matt/chr.

▶ Ohne Zubehör. Bestell-Artikelnummern für Linse, Glas, Farbfilter und die Konfigurationsempfehlung (2) auf der Einklappseite!

▶ Without accessories: Order item-no. for lens, glass, color filter and the recommended Configuration (2) are on the fold-in page!

G9 max. 33W, optional LED Retrofit
 G9 max. 33W, LED Retrofit optional

Leuchtmittlempfehlung: LED max. 3W/300lm/2.700K/dimmbar **G** Art. Nr. 8-205
 bulb recommendation: LED max. 3W/300Lm/2.700K/dimmable **G** Item No. 8-205

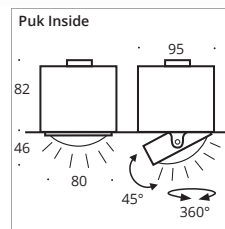
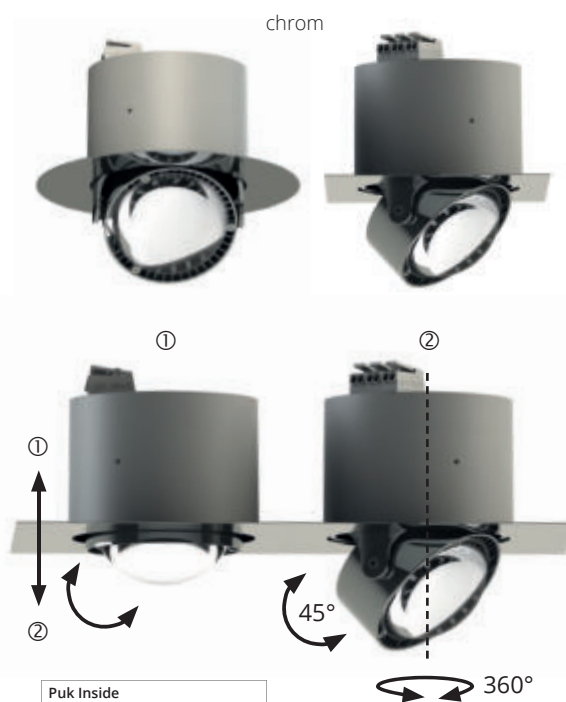
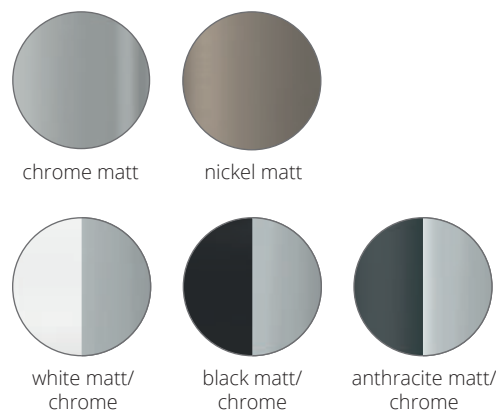

□ Chrom Teile/
chrome parts
■ Gepulverte Teile/
powder-coating

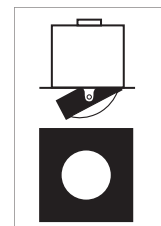
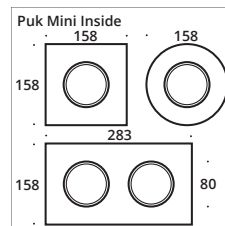





Puk Maxx Inside

Deckeneinbauleuchte als ein- oder zweiflammige Leuchte lieferbar. Kopf dreh- und schwenkbar. Durch Herausziehen des Leuchtenkopfes voller Lichtaustritt bei maximaler Ausschwenkung.

Recessed ceiling luminaire available as single- or double-lamp version. Head can be rotated and swivelled. by pulling out the luminaire head, full light emission at maximum swivel.

INDOOR

Puk Maxx Inside – ☉

Puk Maxx Inside LED G 12W, ~900lm, ~2.700k	Puk Maxx Inside G9 Fassung	∅ ∅ in mm	Gehäuse body
7-71301	7-71301-H	200	chrome matt
7-71302	7-71302-H	200	chrome
7-71303	7-71303-H	200	nickel matt
7-71302-22	7-71302-H-22	200	white matt/chr.
7-71302-02	7-71302-H-02	200	black matt/chr.
7-71302-23	7-71302-H-23	200	anthracite matt/chr.

- ▶ Ohne Zubehör. Bestell-Artikelnummern für Linse, Glas, Farbfilter und die Konfigurationsempfehlung (2) auf der Einklappseite!
- ▶ Without accessories: Order item-no. for lens, glass, color filter and the recommended Configuration (2) are on the fold-in page!



G9 max. 33W, optional LED Retrofit
G9 max. 33W, LED Retrofit optional

Leuchtmittelempfehlung: LED max. 3W/300lm/2.700K/dimmbar G Art. Nr. 8-205
bulb recommendation: LED max. 3W/300Lm/2.700K/dimmable G Item No. 8-205

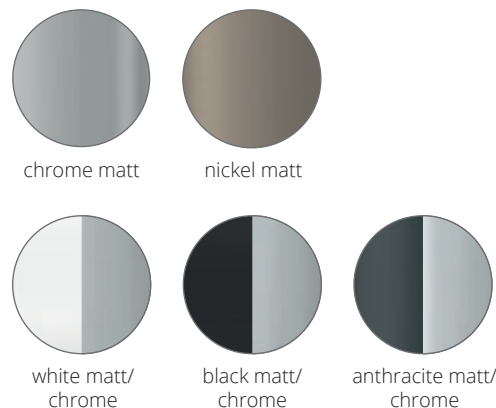

Puk Maxx Inside – ☐

Puk Maxx Inside LED G 12W, ~900lm, ~2.700k	Puk Maxx Inside G9 Fassung	L x B L x B in mm	Gehäuse body
7-72301	7-72301-H	200 x 200	chrome matt
7-72302	7-72302-H	200 x 200	chrome
7-72303	7-72303-H	200 x 200	nickel matt
7-72302-22	7-72302-H-22	200 x 200	white matt/chr.
7-72302-02	7-72302-H-02	200 x 200	black matt/chr.
7-72302-23	7-72302-H-23	200 x 200	anthracite matt/chr.

- ▶ Ohne Zubehör. Bestell-Artikelnummern für Linse, Glas, Farbfilter und die Konfigurationsempfehlung (2) auf der Einklappseite!
- ▶ Without accessories: Order item-no. for lens, glass, color filter and the recommended Configuration (2) are on the fold-in page!



G9 max. 33W, optional LED Retrofit
G9 max. 33W, LED Retrofit optional

Leuchtmittelempfehlung: LED max. 3W/300lm/2.700K/dimmbar G Art. Nr. 8-205
bulb recommendation: LED max. 3W/300Lm/2.700K/dimmable G Item No. 8-205

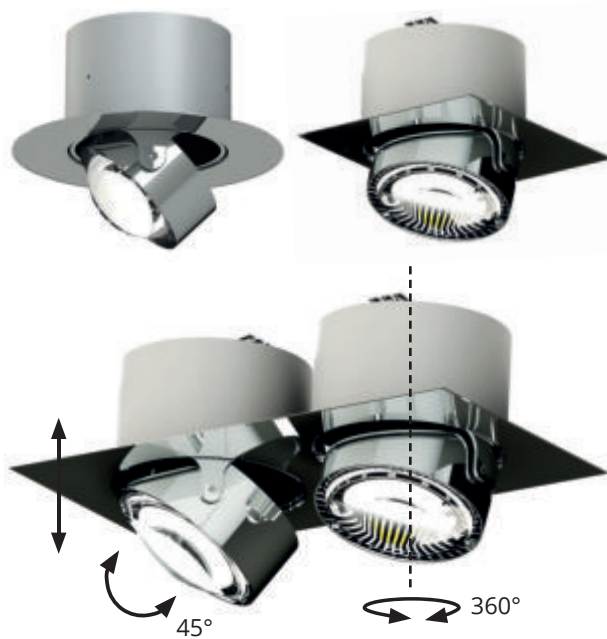

Puk Maxx Inside – ☉☉

Puk Maxx Inside LED G 2 x 12W, ~1.800lm, ~2.700k	Puk Maxx Inside G9 Fassung	L x B L x B in mm	Gehäuse body
7-73301	7-73301-H	368 x 200	chrome matt
7-73302	7-73302-H	368 x 200	chrome
7-73303	7-73303-H	368 x 200	nickel matt
7-73302-22	7-73302-H-22	368 x 200	white matt/chr.
7-73302-02	7-73302-H-02	368 x 200	black matt/chr.
7-73302-23	7-73302-H-23	368 x 200	anthracite matt/chr.

- ▶ Ohne Zubehör. Bestell-Artikelnummern für Linse, Glas, Farbfilter und die Konfigurationsempfehlung (2) auf der Einklappseite!
- ▶ Without accessories: Order item-no. for lens, glass, color filter and the recommended Configuration (2) are on the fold-in page!



G9 max. 33W, optional LED Retrofit
G9 max. 33W, LED Retrofit optional

Leuchtmittelempfehlung: LED max. 3W/300lm/2.700K/dimmbar G Art. Nr. 8-205
bulb recommendation: LED max. 3W/300Lm/2.700K/dimmable G Item No. 8-205

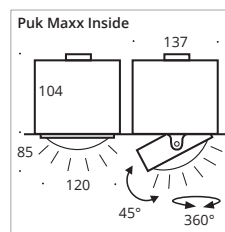

☐ Chrom Teile/
chrome parts

■ Gepulverte Teile/
powder-coating

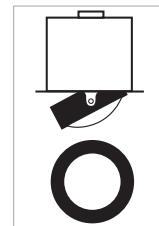
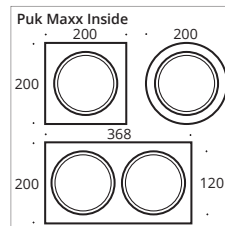



WANDLEUCHTEN

WALL LAMPS



Puk Mini Wall 115
Puk Maxx Wall 117



Puk Mini Wall »+« 119
Puk Maxx Wall »+« 121
Puk Meg Maxx Wall »+« 123



Puk Mini Hotel 125
Puk Maxx Hotel 127



Puk Mini Side Single 129
Puk Maxx Side Single 131



Puk Mini Side Twin 133
Puk Maxx Side Twin 135



Puk Mini Wing Single 137
Puk Maxx Wing Single 139



Puk Mini Wing Twin 141
Puk Maxx Wing Twin 143



Puk Maxx Next 145
Puk Meg Maxx Next 147



Puk Mini Flexlight Wall 149



Puk Mini Choice Wall 151



Puk Mini Choice Wall »+« 153



Focus 100 155
Focus 150 157



Allround Wall 161



Only Choice Wall 163



Only Choice Wall »+« 165



Lichtstange 167



Two Socket 169



Hotel Duo 171



Flexlight Wall 173



Glass- & Spotlight Wall 175





Puk Mini Wall \varnothing 80

Wandleuchte, Hochvolt Halogen, LED Retrofit oder LED Power, dimmbar.
Wall lamp, high voltage halogen, LED Retrofit or LED power, dimmable.

INDOOR



chrome

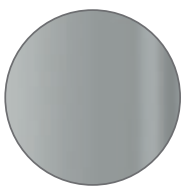

chrome matt

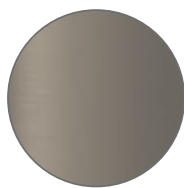

nickel matt

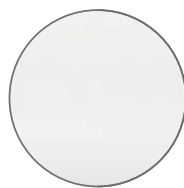

white matt

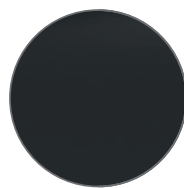

black matt

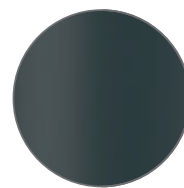

anthracite matt

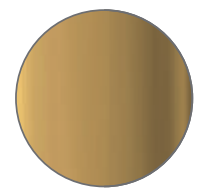

24c gold

Puk Mini Wall LED G 2 x 8W ~1.200lm ~2.700k	Puk Mini Wall LED G 2 x 4W ~600lm ~2.700k	Puk Mini Wall G9 Fassung	Wandab- stand wall spacing in mm	Gehäuse body
2-0811-LED	2-0811-4LED	2-0811	100	chrom matt
2-0812-LED	2-0812-4LED	2-0812	100	chrom
2-0813-LED	2-0813-4LED	2-0813	100	nickel matt
2-0812-LED-WE	2-0812-4LED-WE	2-0812-WE	100	weiß matt
2-0812-LED-BE	2-0812-4LED-BE	2-0812-BE	100	schwarz matt
2-0812-LED-23	2-0812-4LED-23	2-0812-23	100	anthracite matt
2-0816-LED	2-0816-4LED	2-0816	100	24 c. gold pl.

- ▶ Ohne Zubehör. Bestell-Artikelnummern für Linse, Glas, Farbfilter und die Konfigurationsempfehlung auf der Einklapppage!
- ▶ Without accessories: Order item-no. for lens, glass, color filter and the recommended Configuration are on the fold-in page!



Leuchtmittelangabe: LED Retrofit **G inkl.** ~3Watt ~300lm ~2.700K | G9 max. 33W ECO
lamp information: LED Retrofit **G incl.** ~3Watt ~300lm ~2.700K | G9 max. 33W ECO

Leuchtmittelempfehlung: LED max. 3W/300lm/2.700K/dimmbar **G** Art Nr. 8-205
bulb recommendation: LED max. 3W/300Lm/2.700K/dimmable **G** Item No. 8-205

- Chrom Teile/
chrome parts
- Gepulverte Teile/
powder-coating

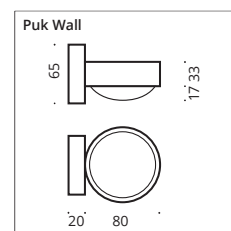





Puk Maxx Wall ø 120

Wandleuchte, LED Power, dimmbar.
Wall lamp, LED power, dimmable.

INDOOR



chrome

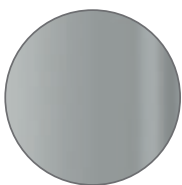

chrome matt



nickel matt

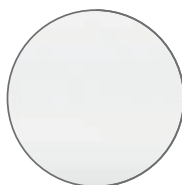

white matt

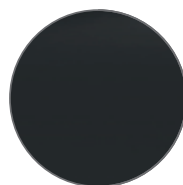

black matt

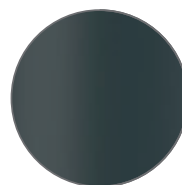

anthracite matt

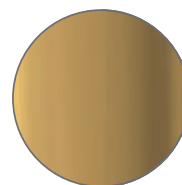

24c gold

Puk Maxx Wall LED G 2 x 12W ~1.800lm ~2.700k	Wandabstand x Höhe in mm wallspace x height in mm	Gehäuse body
2-30811	140 x 80	chrome matt
2-30812	140 x 80	chrome
2-30813	140 x 80	nickel matt
2-30812-WE	140 x 80	white matt
2-30812-BE	140 x 80	black matt
2-30812-23	140 x 80	anthracite matt
2-30816	140 x 80	24 c. gold pl.

- ▶ Ohne Zubehör. Bestell-Artikelnummern für Linse, Glas, Farbfilter und die Konfigurationsempfehlung auf der Einklappseite!
- ▶ Without accessories: Order item-no. for lens, glass, color filter and the recommended configuration are on the fold-in page!

Leuchtmittelangabe: LED **G** inkl. | lamp information: LED **G** incl.

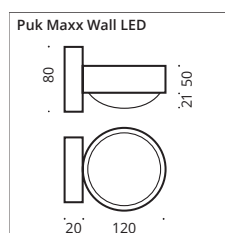





Puk Mini Wall »+« Ø 80

Wandleuchte, Hochvolt Halogen oder LED Power, dimmbar, Kopf **drehbar** mit Verstellstift.
Wall lamp, high voltage halogen or LED power, dimmable, head **rotatable** with adjusting pin.

INDOOR



chrome

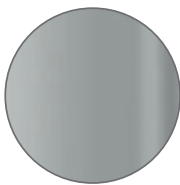

chrome matt



nickel matt

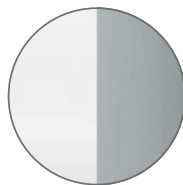

white matt/
chrome

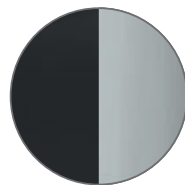

black matt/
chrome

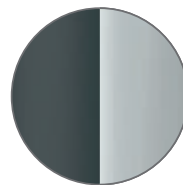

anthracite matt/
chrome

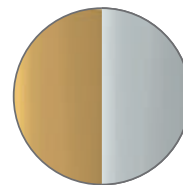

24c gold/
chrom

Puk Wall »+« LED G 2 x 8W ~1.200lm ~2.700k	Puk Wall »+« G9 Fassung	Wandabstand wall spacing in mm	Gehäuse body
2-0801-LED	2-0801	110	chrome matt
2-0802-LED	2-0802	110	chrome
2-0803-LED	2-0803	110	nickel matt
2-0802-LED-22	2-0802-22	110	white matt/chrome
2-0802-LED-02	2-0802-02	110	black matt/chrome
2-0802-LED-23	2-0802-23	110	anthracite matt/chr.
2-0806-LED	2-0806	110	24 ct gold plated/chr.

Chrom Teile/
chrome parts
 Gepulverte Teile/
powder-coating

► Ohne Zubehör. Bestell-Artikelnummern für Linse, Glas, Farbfilter und die Konfigurationsempfehlung auf der Einklappseite!

► Without accessories: Order item-no. for lens, glass, color filter and the recommended Configuration are on the fold-in page!

Leuchtmittelangabe: LED Retrofit **G inkl.** | G9 max. 33W ECO
lamp information: LED Retrofit **G incl.** | G9 max. 33W ECO

Leuchtmittelempfehlung: LED max. 3W/300lm/2.700K/dimmbar **G** Art Nr. 8-205
bulb recommendation: LED max. 3W/300Lm/2.700K/dimmable **G** Item No. 8-205

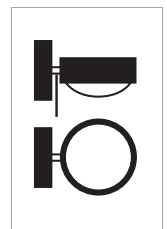
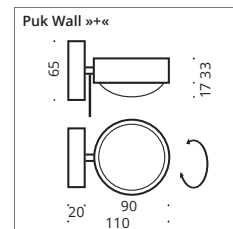





Puk Maxx Wall »+« Ø 120

Wandleuchte, Hochvolt Halogen oder LED Power, Kopf **drehbar** mit Verstellstift, dimmbar.
Wall lamp, high voltage halogen or LED power, head **rotatable** with adjusting pin, dimmable.

INDOOR



chrome

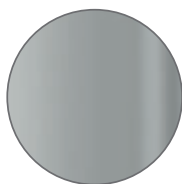

chrome matt



nickel matt

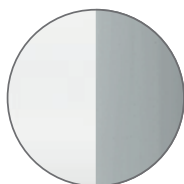

white matt/
chrome

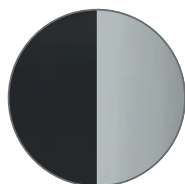

black matt/
chrome

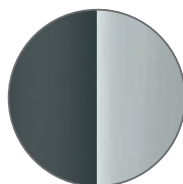

anthracite matt/
chrome

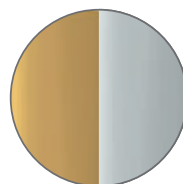

24c gold/
chrom

Puk Maxx Wall »+« LED G 2 x 12W ~1.800lm ~2.700k	Puk Maxx Wall »+« G9 Fassung	Wandabstand x Höhe wallspace x height in mm	Gehäuse body
2-30801	2-30801-H	150 x 80	chrome matt
2-30802	2-30802-H	150 x 80	chrome
2-30803	2-30803-H	150 x 80	nickel matt
2-30802-22	2-30802-H-22	150 x 80	white matt/chrome
2-30802-02	2-30802-H-02	150 x 80	black matt/chrome
2-30802-23	2-30802-H-23	150 x 80	anthracite matt/chrome
2-30806	2-30806-H	150 x 80	24 ct gold plated/chr.

▶ Ohne Zubehör. Bestell-Artikelnummern für Linse, Glas, Farbfilter und die Konfigurationsempfehlung auf der Einklappseite!



▶ Without accessories: Order item-no. for lens, glass, color filter and the recommended Configuration are on the fold-in page!

Leuchtmittelangabe: LED **G** inkl. | G9 max. 33W ECO, optional LED Retrofit
bulb information: LED **G** incl. | G9 max. 33W ECO, LED Retrofit optional

Leuchtmittelempfehlung: LED max. 3W/300lm/2.700K/dimmbar **G** Art Nr. 8-205
bulb recommendation: LED max. 3W/300Lm/2.700K/dimmable **G** Item No. 8-205

Puk Maxx Wall



Chrom Teile/
chrome parts

Gepulverte Teile/
powder-coating

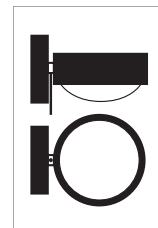
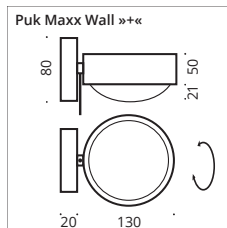





Puk Meg Maxx Wall »+« Ø 160

Wandleuchte, Hochvolt LED Power oder Hochvolt Halogen, Kopf **drehbar** mit Verstellstift, dimmbar.
Wall lamp, high LED power or high voltage halogen, head **rotatable** with adjusting pin, dimmable.

INDOOR



chrome

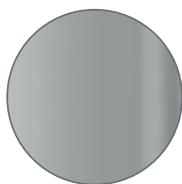

chrome matt



nickel matt

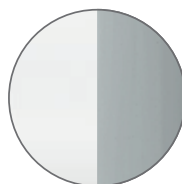

white matt/
chrome

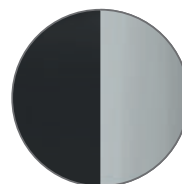

black matt/
chrome

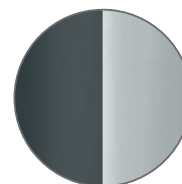

anthracite matt/
chrome

Puk Meg Maxx Wall »+« LED G 2 x 18W ~3.000lm, ~2.700k	Puk Meg Maxx Wall »+« G9 Fassung	Ø x Wand- abstand Ø x wall space in mm	Gehäuse body
2-40801	2-40801-H	160 x 185	chrome matt
2-40802	2-40802-H	160 x 185	chrome
2-40803	2-40803-H	160 x 185	nickel matt
2-40802-22	2-40802-H-22	160 x 185	white matt/chrome
2-40802-02	2-40802-H-02	160 x 185	black matt/chrome
2-40802-23	2-40802-H-23	160 x 185	anthracite matt/chr.

▶ Ohne Zubehör. Bestell-Artikelnummern für Linse, Glas, Farbfilter und die Konfigurationsempfehlung auf der Einklappseite!



▶ Without accessories: Order item-no. for lens, glass, color filter and the recommended Configuration are on the fold-in page!

Leuchtmittelangabe: LED **G** inkl. | G9 max. 33W ECO, optional LED Retrofit bulb information: LED **G** incl. | G9 max. 33W ECO, LED Retrofit optional

Leuchtmittelpfehlung: LED max. 3W/300lm/2.700K/dimmbar **G** Art Nr. 8-205
bulb recommendation: LED max. 3W/300Lm/2.700K/dimmable **G** Item No. 8-205

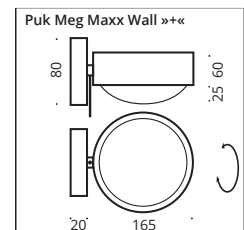

Chrom Teile/
chrome parts

Gepulverte Teile/
powder-coating

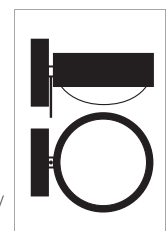





Puk Mini Hotel ø 80

Wandleuchte, Hochvolt Halogen oder LED Power, dimmbar, Arm schwenkbar, Köpfe drehbar mit Verstellstift. Ideal für die Anwendung als Bettleseleuchte.

Wall luminaires, high voltage halogen or LED power, dimmable, arm swivelling, heads rotatable with adjustment pin. Ideal for use as bedside reading lamp.

INDOOR

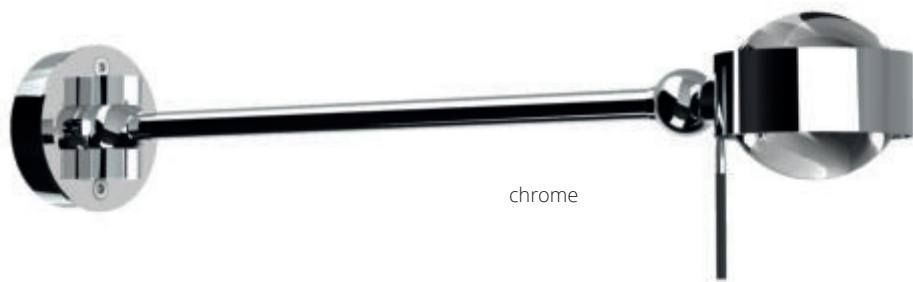

chrome

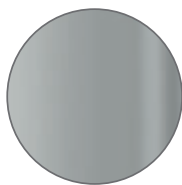

chrome matt

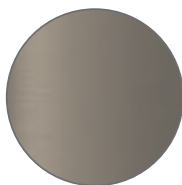

nickel matt

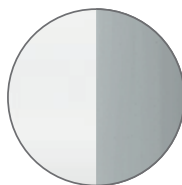

white matt/
chrome

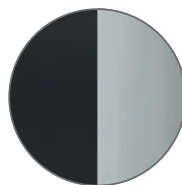

black matt/
chrome

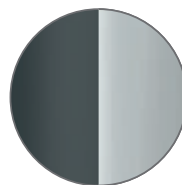

anthracite matt/
chrome

Puk Mini Hotel LED G 2 x 8W ~1.200lm ~2.700k	Puk Mini Hotel G9 Fassung	Armlänge arm length in mm	Gehäuse body
● 2-058201-LED	2-058201	200	chrome matt
● 2-058202-LED	2-058202	200	chrome
● 2-058203-LED	2-058203	200	nickel matt
● 2-058202-LED-22	2-058202-22	200	white matt/chrome
● 2-058202-LED-02	2-058202-02	200	black matt/chrome
● 2-058202-LED-23	2-058202-23	200	anthracite matt/chr.
● 2-058301-LED	2-058301	300	chrome matt
● 2-058302-LED	2-058302	300	chrome
● 2-058303-LED	2-058303	300	nickel matt
● 2-058302-LED-22	2-058302-22	300	white matt/chrome
● 2-058302-LED-02	2-058302-02	300	black matt/chrome
● 2-058302-LED-23	2-058302-23	300	anthracite matt/chr.

-K Schaltermontage optional rechts/links.
Switch mounting optional right/left.

Sonderlängen auf Anfrage. Special lengths on request.

- ▶ Ohne Zubehör. Bestell-Artikelnummern für Linse, Glas, Farbfilter und die Konfigurationsempfehlung auf der Einklappseite!
- ▶ Without accessories: Order item-no. for lens, glass, color filter and the recommended Configuration are on the fold-in page!

Leuchtmittelangabe: LED G inkl. | G9 max. 33W ECO, optional LED Retrofit
bulb information: LED G incl. | G9 max. 33W ECO, LED Retrofit optional

Leuchtmittelempfehlung: LED max. 3W/300lm/2.700K/dimmbar G Art Nr. 8-205
bulb recommendation: LED max. 3W/300Lm/2.700K/dimmable G Item No. 8-205



□ Chrom Teile/
chrome parts
■ Gepulverte Teile/
powder-coating

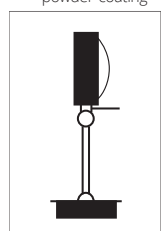
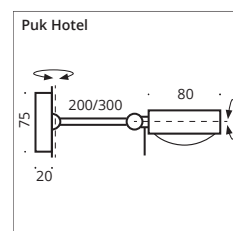





Puk Maxx Hotel ø 120

Wandleuchte, Hochvolt Halogen oder LED Power, dimmbar, Arm schwenkbar, Köpfe drehbar mit Verstellstift. Ideal für die Anwendung als Bettleseleuchte.

Wall luminaires, high voltage halogen or LED power, dimmable, arm swivelling, heads rotatable with adjustment pin. Ideal for use as bedside reading lamp.

INDOOR

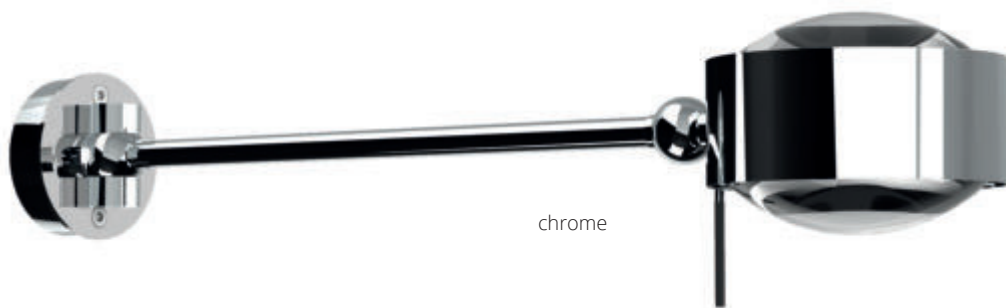

chrome

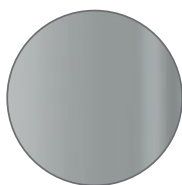

chrome matt



nickel matt

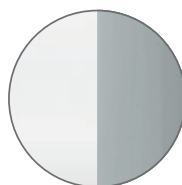

white matt/
chrome

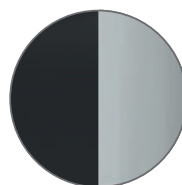

black matt/
chrome

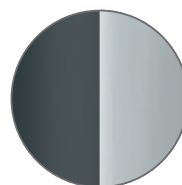

anthracite matt/
chrome

Puk Maxx Hotel LED G 2 x 12W ~1.800lm ~2.700k	Puk Maxx Hotel G9 Fassung	Armlänge arm length in mm	Gehäuse body
2-3058201-LED	2-3058201	200	chrome matt
2-3058202-LED	2-3058202	200	chrome
2-3058203-LED	2-3058203	200	nickel matt
2-3058202-LED-22	2-3058202-22	200	white matt/chrome
2-3058202-LED-02	2-3058202-02	200	black matt/chrome
2-3058202-LED-23	2-3058202-23	200	anthracite matt/chr.
2-3058301-LED	2-3058301	300	chrome matt
2-3058302-LED	2-3058302	300	chrome
2-3058303-LED	2-3058303	300	nickel matt
2-3058302-LED-22	2-3058302-22	300	white matt/chrome
2-3058302-LED-02	2-3058302-02	300	black matt/chrome
2-3058302-LED-23	2-3058302-23	300	anthracite matt/chr.

-K Schaltermontage optional rechts/links.
Switch mounting optional right/left.

Sonderlängen auf Anfrage. Special lengths on request.

- ▶ Ohne Zubehör. Bestell-Artikelnummern für Linse, Glas, Farbfilter und die Konfigurationsempfehlung auf der Einklappseite!
- ▶ Without accessories: Order item-no. for lens, glass, color filter and the recommended Configuration are on the fold-in page!

Leuchtmittelangabe: LED **G** inkl. | G9 max. 33W ECO, optional LED Retrofit
bulb information: LED **G** incl. | G9 max. 33W ECO, LED Retrofit optional

Leuchtmittlempfehlung: LED max. 3W/300lm/2.700K/dimmbar **G** Art Nr. 8-205
bulb recommendation: LED max. 3W/300Lm/2.700K/dimmable **G** Item No. 8-205



Chrom Teile/
chrome parts
 Gepulverte Teile/
powder-coating

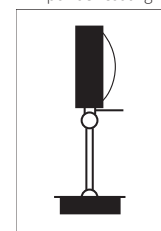
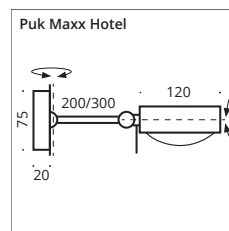



Puk Mini Side Single



Puk Mini Side Single ø 80

Wandleuchte, Hochvolt Halogen oder LED Power, dimmbar, Kopf drehbar mit Verstellstift. Mit drehbarem Arm (bis 350°).

Wall, ceiling luminaire, high voltage halogen or LED power, dimmable. Head rotatable with adjustment pin. With turnable arm (up to 350°).

INDOOR

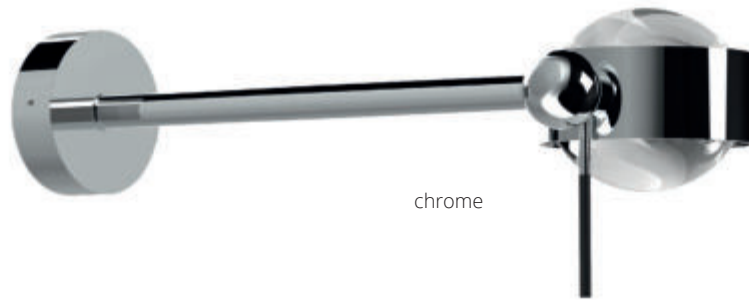

chrome

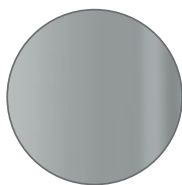

chrome matt

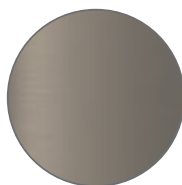

nickel matt

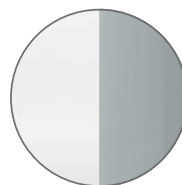

white matt/
chrome

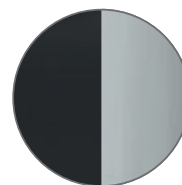

black matt/
chrome

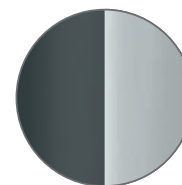

anthracite matt/
chrome

Puk Side Single LED G 2 x 8W ~1.200lm ~2.700k	Puk Side Single G9 Fassung	Armlänge arm length in mm	Gehäuse body
2-0821-LED	2-0821	100	chrome matt
2-0822-LED	2-0822	100	chrome
2-0823-LED	2-0823	100	nickel matt
2-0822-LED-22	2-0822-22	100	white matt/chr.
2-0822-LED-02	2-0822-02	100	black matt/chr.
2-0822-LED-23	2-0822-23	100	anthracite matt/chr.
2-0831-LED	2-0831	200	chrome matt
2-0832-LED	2-0832	200	chrome
2-0833-LED	2-0833	200	nickel matt
2-0832-LED-22	2-0832-22	200	white matt/chr.
2-0832-LED-02	2-0832-02	200	black matt/chr.
2-0832-LED-23	2-0832-23	200	anthracite matt/chr.
2-0861-LED	2-0861	300	chrome matt
2-08062-LED	2-08062	300	chrome
2-0863-LED	2-0863	300	nickel matt
2-08062-LED-22	2-08062-22	300	white matt/chr.
2-08062-LED-02	2-08062-02	300	black matt/chr.
2-08062-LED-23	2-08062-23	300	anthracite matt/chr.

▶ Ohne Zubehör. Bestell-Artikelnummern für Linse, Glas, Farbfilter und die Konfigurationsempfehlung auf der Einklappseite!



▶ Without accessories: Order item-no. for lens, glass, color filter and the recommended Configuration are on the fold-in page!

G9 max. 33W ECO, optional LED Retrofit
G9 max. 33W ECO, LED Retrofit optional

Leuchtmittelempfehlung: LED max. 3W/300lm/2.700K/dimmbar **G** Art Nr. 8-205
bulb recommendation: LED max. 3W/300Lm/2.700K/dimmable **G** Item No. 8-205

Chrom Teile/
chrome parts
 Gepulverte Teile/
powder-coating

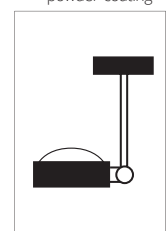
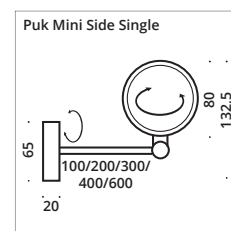





Puk Maxx Side Single \varnothing 120

Wandleuchte mit Arm, Hochvolt Halogen oder LED Power, Kopf drehbar. Mit drehbarem Arm (bis 350°).

Wall, ceiling luminaire, high voltage halogen or LED power, dimmable. Head rotatable with adjustment pin. With turnable arm (up to 350°).

INDOOR

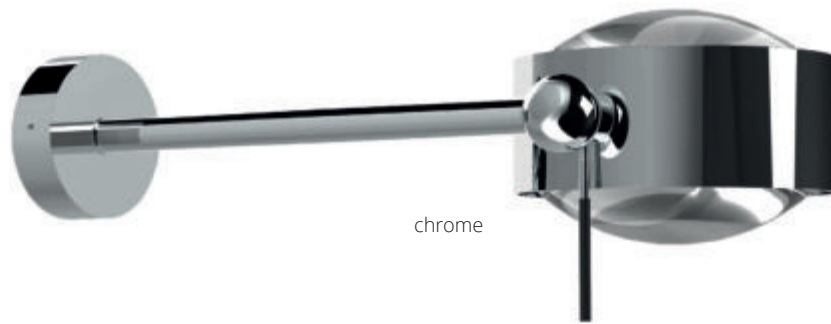

chrome

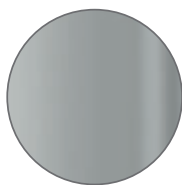

chrome matt

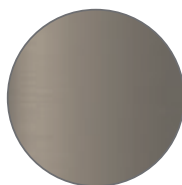

nickel matt

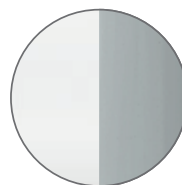

white matt/
chrome

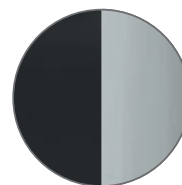

black matt/
chrome

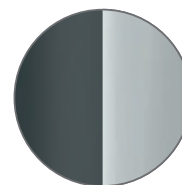

anthracite matt/
chrome

Puk Maxx Side Single LED G 2 x 12W ~1.800lm ~2.700k	Puk Maxx Side Single G9 Fassung	Armlänge arm length in mm	Gehäuse body
2-30821	2-30821-H	100	chrome matt
2-30822	2-30822-H	100	chrome
2-30823	2-30823-H	100	nickel matt
2-30822-22	2-30822-H-22	100	white matt/chr.
2-30822-02	2-30822-H-02	100	black matt/chr.
2-30822-23	2-30822-H-23	100	anthracite matt/chr.
2-30831	2-30831-H	200	chrome matt
2-30832	2-30832-H	200	chrome
2-30833	2-30833-H	200	nickel matt
2-30832-22	2-30832-H-22	200	white matt/chr.
2-30832-02	2-30832-H-02	200	black matt/chr.
2-30832-23	2-30832-H-23	200	anthracite matt/chr.
2-30861	2-30861-H	300	chrome matt
2-30862	2-30862-H	300	chrome
2-30863	2-30863-H	300	nickel matt
2-30862-22	2-30862-H-22	300	white matt/chr.
2-30862-02	2-30862-H-02	300	black matt/chr.
2-30862-23	2-30862-H-23	300	anthracite matt/chr.

► Ohne Zubehör. Bestell-Artikelnummern für Linse, Glas, Farbfilter und die Konfigurationsempfehlung auf der Einklappseite!



► Without accessories: Order item-no. for lens, glass, color filter and the recommended Configuration are on the fold-in page!

G9 max. 33W ECO, optional LED Retrofit
 G9 max. 33W ECO, LED Retrofit optional

Leuchtmittelempfehlung: LED max. 3W/300lm/2.700K/dimmbar **G** Art Nr. 8-205
 bulb recommendation: LED max. 3W/300Lm/2.700K/dimmable **G** Item No. 8-205

Chrom Teile/
chrome parts
 Gepulverte Teile/
powder-coating

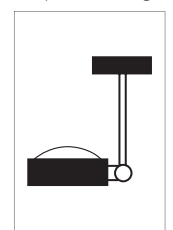
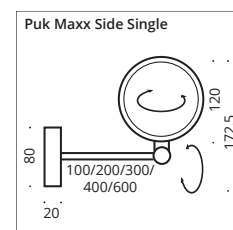



Puk Mini Side Twin



Puk Mini Side Twin \varnothing 80

Wandleuchte, Hochvolt Halogen oder LED Power, dimmbar, Köpfe drehbar mit Verstellstift. Mit drehbarem Arm (bis 350°).

Wall, ceiling luminaire, high voltage halogen or LED power, dimmable. Head rotatable with adjustment pin. Now with turable arm (350°).

INDOOR



chrome

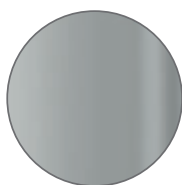

chrome matt



nickel matt

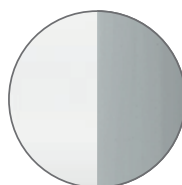

white matt/
chrome

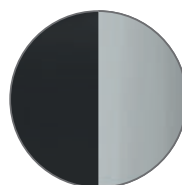

black matt/
chrome

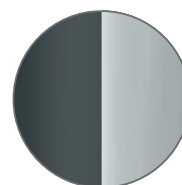

anthracite matt/
chrome

Puk Side Twin LED G 4 x 8W ~2.400lm ~2.700k	Puk Side Twin G9 Fassung	Armlänge arm length in mm	Gehäuse body
2-0841-LED	2-0841	100	chrome matt
2-0842-LED	2-0842	100	chrome
2-0843-LED	2-0843	100	nickel matt
2-0842-LED-22	2-0842-22	100	white matt/chr.
2-0842-LED-02	2-0842-02	100	black matt/chr.
2-0842-LED-23	2-0842-23	100	anthracite matt/chr.
2-0851-LED	2-0851	200	chrome matt
2-0852-LED	2-0852	200	chrome
2-0853-LED	2-0853	200	nickel matt
2-0852-LED-22	2-0852-22	200	white matt/chr.
2-0852-LED-02	2-0852-02	200	black matt/chr.
2-0852-LED-23	2-0852-23	200	anthracite matt/chr.

► Ohne Zubehör. Bestell-Artikelnummern für Linse, Glas, Farbfilter und die Konfigurationsempfehlung auf der Einklappseite!



► Without accessories: Order item-no. for lens, glass, color filter and the recommended Configuration are on the fold-in page!

Light bulb icon: G9 max. 33W ECO, optional LED Retrofit
Light bulb icon: G9 max. 33W ECO, LED Retrofit optional

Light bulb icon: Leuchtmittelempfehlung: LED max. 3W/300lm/2.700K/dimmbar Art Nr. 8-205
Light bulb icon: bulb recommendation: LED max. 3W/300Lm/2.700K/dimmable Item No. 8-205

Chrom Teile/
chrome parts
Gepulverte Teile/
powder-coating

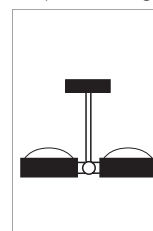
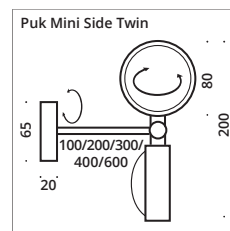





Puk Maxx Side Twin ø 120

Wandleuchte mit Arm, Hochvolt Halogen oder LED Power, Köpfe drehbar. Mit drehbarem Arm (bis 350°).

Wall, ceiling luminaire, high voltage halogen or LED power, dimmable. Head rotatable with adjustment pin. Now with turable arm (350°).

INDOOR



chrome

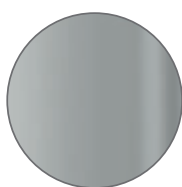

chrome matt



nickel matt

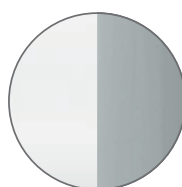

white matt/
chrome

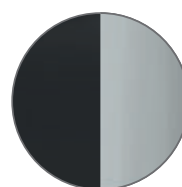

black matt/
chrome

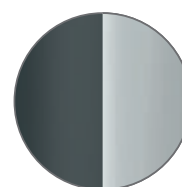

anthracite matt/
chrome

Puk Maxx Side Twin LED G 4 x 12W ~3.600lm ~2.700k	Puk Maxx Side Twin G9 Fassung	Armlänge arm length in mm	Gehäuse body
2-30841	2-30841-H	100	chrome matt
2-30842	2-30842-H	100	chrome
2-30843	2-30843-H	100	nickel matt
2-30842-22	2-30842-H-22	100	white matt/chr.
2-30842-02	2-30842-H-02	100	black matt/chr.
2-30842-23	2-30842-H-23	100	anthracite matt/chr.
2-30851	2-30851-H	200	chrome matt
2-30852	2-30852-H	200	chrome
2-30853	2-30853-H	200	nickel matt
2-30852-22	2-30852-H-22	200	white matt/chr.
2-30852-02	2-30852-H-02	200	black matt/chr.
2-30852-23	2-30852-H-23	200	anthracite matt/chr.

▶ Ohne Zubehör. Bestell-Artikelnummern für Linse, Glas, Farbfilter und die Konfigurationsempfehlung auf der Einklapppage!



▶ Without accessories: Order item-no. for lens, glass, color filter and the recommended Configuration are on the fold-in page!

G9 max. 33W ECO, optional LED Retrofit

G9 max. 33W ECO, LED Retrofit optional

Leuchtmittel Empfehlung: LED max. 3W/300lm/2.700K/dimmbar **G** Art Nr. 8-205
 bulb recommendation: LED max. 3W/300Lm/2.700K/dimmable **G** Item No. 8-205



ABC (s.S 6-7/s.p. 6-7)

Chrom Teile/
chrome parts
 Gepulverte Teile/
powder-coating

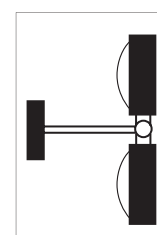
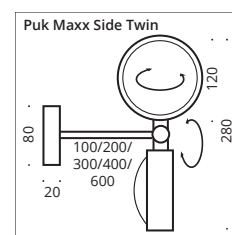



Puk Mini Wing Single



Puk Mini Wing Single \varnothing 80

Wandleuchte, Hochvolt Halogen oder LED Power, dimmbar, Kopf drehbar mit Verstellstift, Arm schwenkbar.

Wall luminaires, high voltage halogen or LED power, dimmable, arm swivelling, heads rotatable with adjustment pin.

INDOOR



chrome

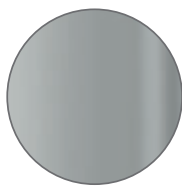

chrome matt

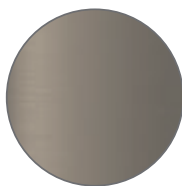

nickel matt

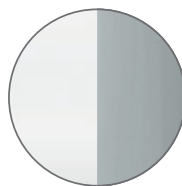

white matt/
chrome

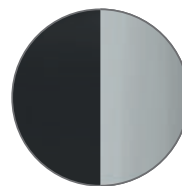

black matt/
chrome

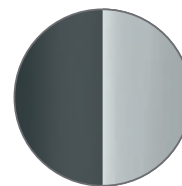

anthracite matt/
chrome

Puk Wing Single LED G 2 x 8W ~1.200lm ~2.700k	Puk Wing Single G9 Fassung L	Armlänge arm length in mm	Gehäuse body
● 2-08201-LED	2-08201	200	chrome matt
● 2-08202-LED	2-08202	200	chrome
● 2-08203-LED	2-08203	200	nickel matt
● 2-08202-LED-22	2-08202-22	200	white matt/chr.
● 2-08202-LED-02	2-08202-02	200	black matt/chr.
● 2-08202-LED-23	2-08202-23	200	anthracite matt/chr.
● 2-08301-LED	2-08301	300	chrome matt
● 2-08302-LED	2-08302	300	chrome
● 2-08303-LED	2-08303	300	nickel matt
● 2-08302-LED-22	2-08302-22	300	white matt/chr.
● 2-08302-LED-02	2-08302-02	300	black matt/chr.
● 2-08302-LED-23	2-08302-23	300	anthracite matt/chr.
● 2-08401-LED	2-08401	400	chrome matt
● 2-08402-LED	2-08402	400	chrome
● 2-08403-LED	2-08403	400	nickel matt
● 2-08402-LED-22	2-08402-22	400	white matt/chr.
● 2-08402-LED-02	2-08402-02	400	black matt/chr.
● 2-08402-LED-23	2-08402-23	400	anthracite matt/chr.

► Ohne Zubehör. Bestell-Artikelnummern für Linse, Glas, Farbfilter und die Konfigurationsempfehlung auf der Einklapppage!



► Without accessories: Order item-no. for lens, glass, color filter and the recommended Configuration are on the fold-in page!

L G9 max. 33W ECO, optional LED Retrofit
L G9 max. 33W ECO, LED Retrofit optional

L Leuchtmittelempfehlung: LED max. 3W/300lm/2.700K/dimmbar **G** Art Nr. 8-205
L bulb recommendation: LED max. 3W/300Lm/2.700K/dimmable **G** Item No. 8-205

□ Chrom Teile/
chrome parts
 ■ Gepulverte Teile/
powder-coating

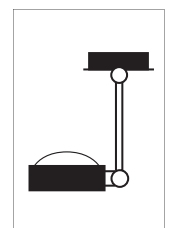
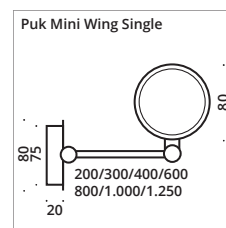



Puk Maxx Wing Single



Puk Maxx Wing Single ø 120

Wandleuchte, Hochvolt Halogen oder LED Power, dimmbar, Kopf drehbar mit Verstellstift, Arm schwenkbar.

Wall luminaires, high voltage halogen or LED power, dimmable, arm swivelling, heads rotatable with adjustment pin.

INDOOR



chrome

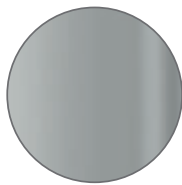

chrome matt

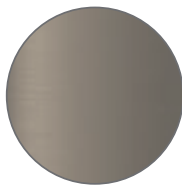

nickel matt

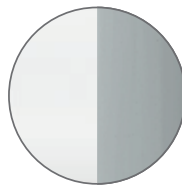

white matt/
chrome

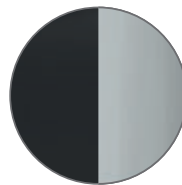

black matt/
chrome

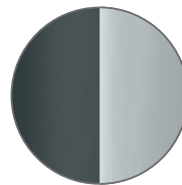

anthracite matt/
chrome

Puk Maxx Wing Single LED G 2 x 12W ~1.800lm ~2.700k	Puk Maxx Wing Single G9 Fassung	Armlänge arm length in mm	Gehäuse body
● 2-38201	2-38201-H	200	chrome matt
● 2-38202	2-38202-H	200	chrome
● 2-38203	2-38203-H	200	nickel matt
● 2-38202-22	2-38202-H-22	200	white matt/chr.
● 2-38202-02	2-38202-H-02	200	black matt/chr.
● 2-38202-23	2-38202-H-23	200	anthracite matt/chr.
● 2-38301	2-38301-H	300	chrome matt
● 2-38302	2-38302-H	300	chrome
● 2-38303	2-38303-H	300	nickel matt
● 2-38302-22	2-38302-H-22	300	white matt/chr.
● 2-38302-02	2-38302-H-02	300	black matt/chr.
● 2-38302-23	2-38302-H-23	300	anthracite matt/chr.

▶ Ohne Zubehör. Bestell-Artikelnummern für Linse, Glas, Farbfilter und die Konfigurationsempfehlung auf der Einklappseite!



▶ Without accessories: Order item-no. for lens, glass, color filter and the recommended Configuration are on the fold-in page!

💡 G9 max. 33W ECO, optional LED Retrofit
G9 max. 33W ECO, LED Retrofit optional

💡 Leuchtmittelempfehlung: LED max. 3W/300lm/2.700K/dimmbar **G** Art Nr. 8-205
bulb recommendation: LED max. 3W/300Lm/2.700K/dimmable **G** Item No. 8-205

☐ Chrom Teile/
chrome parts
■ Gepulverte Teile/
powder-coating

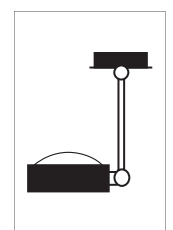
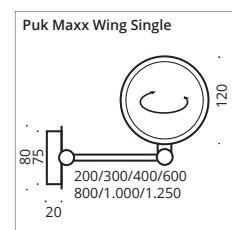



Puk Mini Wing Twin



Puk Mini Wing Twin \varnothing 80

Wandleuchte, Hochvolt Halogen oder LED Power, dimmbar, Kopf drehbar mit Verstellstift, Arm schwenkbar.

Wall luminaires, high voltage halogen or LED power, dimmable, arm swivelling, heads rotatable with adjustment pin.

INDOOR

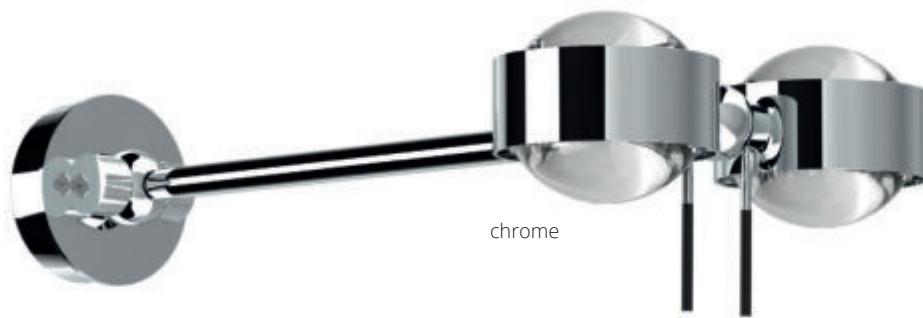

chrome

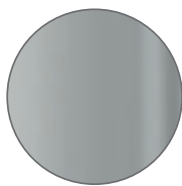

chrome matt

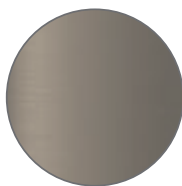

nickel matt

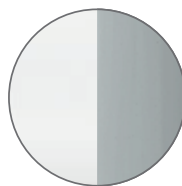

white matt/
chrome

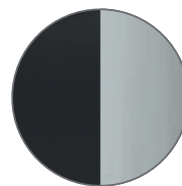

black matt/
chrome

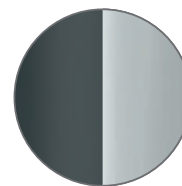

anthracite matt/
chrome

Puk Wing Twin LED G 4 x 8W ~2.400lm ~2.700k	Puk Wing Twin G9 Fassung	Armlänge arm length in mm	Gehäuse body
2-09201-LED	2-09201	200	chrome matt
2-09202-LED	2-09202	200	chrome
2-09203-LED	2-09203	200	nickel matt
2-09202-LED-22	2-09202-22	200	white matt/chr.
2-09202-LED-02	2-09202-02	200	black matt/chr.
2-09202-LED-23	2-09202-23	200	anthracite matt/chr.
2-09301-LED	2-09301	300	chrome matt
2-09302-LED	2-09302	300	chrome
2-09303-LED	2-09303	300	nickel matt
2-09302-LED-22	2-09302-22	300	white matt/chr.
2-09302-LED-02	2-09302-02	300	black matt/chr.
2-09302-LED-23	2-09302-23	300	anthracite matt/chr.
2-09401-LED	2-09401	400	chrome matt
2-09402-LED	2-09402	400	chrome
2-09403-LED	2-09403	400	nickel matt
2-09402-LED-22	2-09402-22	400	white matt/chr.
2-09402-LED-02	2-09402-02	400	black matt/chr.
2-09402-LED-23	2-09402-23	400	anthracite matt/chr.

► Ohne Zubehör. Bestell-Artikelnummern für Linse, Glas, Farbfilter und die Konfigurationsempfehlung auf der Einklappseite!

► Without accessories: Order item-no. for lens, glass, color filter and the recommended Configuration are on the fold-in page!

G9 max. 33W ECO, optional LED Retrofit
G9 max. 33W ECO, LED Retrofit optional

Leuchtmittelempfehlung: LED max. 3W/300lm/2.700K/dimmbar Art Nr. 8-205
bulb recommendation: LED max. 3W/300lm/2.700K/dimmable Item No. 8-205

Chrom Teile/
chrome parts
 Gepulverte Teile/
powder-coating

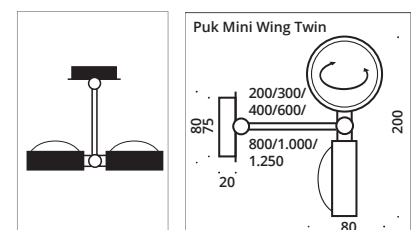





Puk Maxx Wing Twin ø 120

Wandleuchte, Hochvolt Halogen oder LED Power, dimmbar, Kopf drehbar mit Verstellstift, Arm schwenkbar.

Wall luminaires, high voltage halogen or LED power, dimmable, arm swivelling, heads rotatable with adjustment pin.

INDOOR



chrome

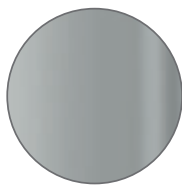

chrome matt

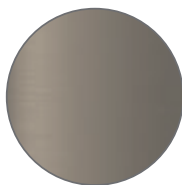

nickel matt

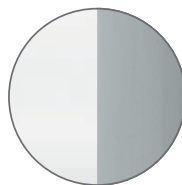

white matt/
chrome

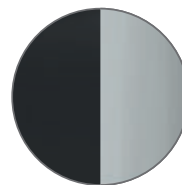

black matt/
chrome

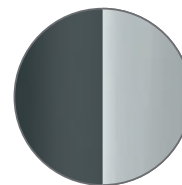

anthracite matt/
chrome

Puk Maxx Wing Twin LED G 4 x 12W ~3.600lm ~2.700k	Puk Maxx Wing Twin G9 Fassung L	Armlänge arm length in mm	Gehäuse body
2-39201	2-39201-H	200	chrome matt
2-39202	2-39202-H	200	chrome
2-39203	2-39203-H	200	nickel matt
2-39202-22	2-39202-H-22	200	white matt/chr.
2-39202-02	2-39202-H-02	200	black matt/chr.
2-39202-23	2-39202-H-23	200	anthracite matt/chr.
2-39301	2-39301-H	300	chrome matt
2-39302	2-39302-H	300	chrome
2-39303	2-39303-H	300	nickel matt
2-39302-22	2-39302-H-22	300	white matt/chr.
2-39302-02	2-39302-H-02	300	black matt/chr.
2-39302-23	2-39302-H-23	300	anthracite matt/chr.

▶ Ohne Zubehör. Bestell-Artikelnummern für Linse, Glas, Farbfilter und die Konfigurationsempfehlung auf der Einklapppage!



▶ Without accessories: Order item-no. for lens, glass, color filter and the recommended Configuration are on the fold-in page!

L G9 max. 33W ECO, optional LED Retrofit
L G9 max. 33W ECO, LED Retrofit optional

L Leuchtmittelempfehlung: LED max. 3W/300lm/2.700K/dimmbar **G** Art Nr. 8-205
L bulb recommendation: LED max. 3W/300Lm/2.700K/dimmable **G** Item No. 8-205

□ Chrom Teile/
chrome parts
■ Gepulverte Teile/
powder-coating

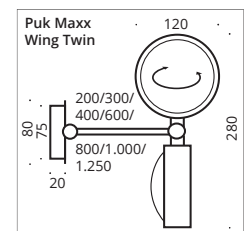
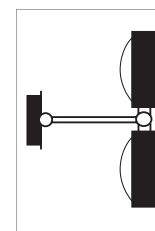





Puk Maxx Next ø 120

Deckenleuchte, Hochvolt LED Power oder Hochvolt Halogen, dimmbar. Diese Aufbauleuchte wurde für den Wand- und Deckeneinsatz konstruiert. Mit zwei kardanis aufeinander abgestimmten Gelenken, lassen sich die Leuchtenköpfe um über 360 Grad auf zwei Achsen in jede Richtung einstellen.

Ceiling lamp, high voltage LED power or high voltage halogen, dimmable. The shaped lamp is dimmable and has been designed for ceilings and walls. With its two coordinated gimbal joints the head can be turned in two axes for more than over 360° in each direction.

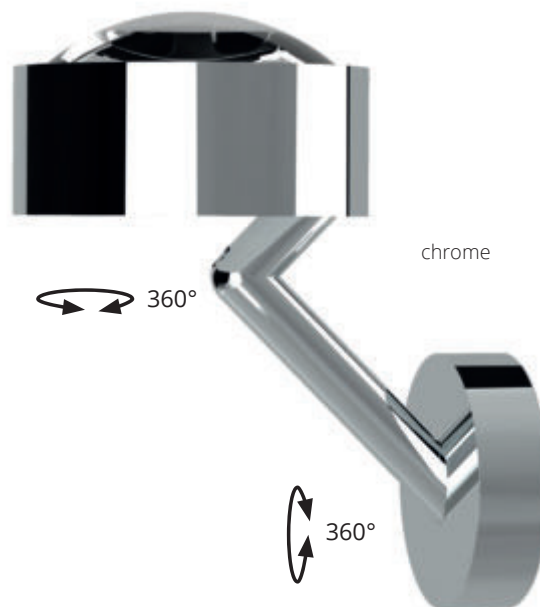
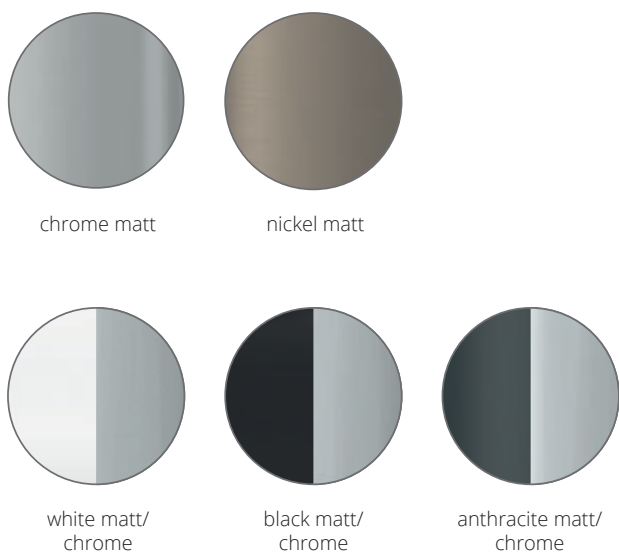

INDOOR

Puk Maxx Next LED G ~2.700k	Puk Maxx Next G9 Fassung	Kopf ø Head ø in mm	Gehäuse body
downlight 1 x 12W, ~900lm	downlight		
2-30721	2-30721-H	120	chrome matt
2-30722	2-30722-H	120	chrome
2-30723	2-30723-H	120	nickel matt
2-30722-22	2-30722-H-22	120	white matt/chr.
2-30722-02	2-30722-H-02	120	black matt/chr.
2-30722-23	2-30722-H-23	120	anthracite matt/chr.
up- & downlight 2 x 12W, ~1.800lm	up- & downlight		
2-30731	2-30731-H	120	chrome matt
2-30732	2-30732-H	120	chrome
2-30733	2-30733-H	120	nickel matt
2-30732-22	2-30732-H-22	120	white matt/chr.
2-30732-02	2-30732-H-02	120	black matt/chr.
2-30732-23	2-30732-H-23	120	anthracite matt/chr.

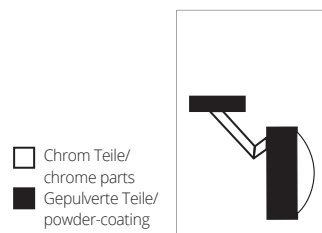

- ▶ Ohne Zubehör. Bestell-Artikelnummern für Linse, Glas, Farbfilter und die Konfigurationsempfehlung auf der Einklappseite!
- ▶ Without accessories: Order item-no. for lens, glass, color filter and the recommended Configuration are on the fold-in page!

G9 max. 33W ECO, optional LED Retrofit
G9 max. 33W ECO, LED Retrofit optional

Leuchtmittelempfehlung: LED max. 3W/300lm/2.700K/dimmbar Art Nr. 8-205
bulb recommendation: LED max. 3W/300Lm/2.700K/dimmable Item No. 8-205

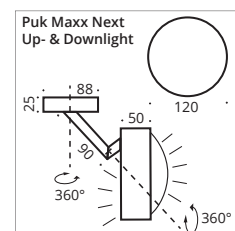
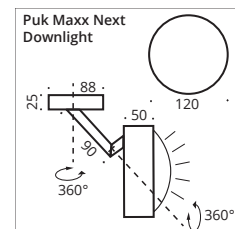





Puk Meg Maxx Next ø 160

Deckenleuchte, Hochvolt LED Power oder Hochvolt Halogen, dimmbar. Diese Aufbauleuchte wurde für den Wand- und Deckeneinsatz konstruiert, dimmbar. Mit zwei kardänisch aufeinander abgestimmten Gelenken, lassen sich die LED oder Halogen Leuchtenköpfe um über 360° drehen.

Ceiling lamp, high voltage LED power or high voltage halogen, dimmable. The shaped lamp is dimmable and has been designed for ceilings and walls. With its two coordinated gimbal-joints the LED or halogen lighted head can be turned for more than over 360°.

INDOOR

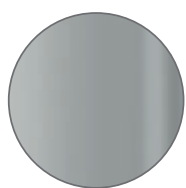

chrome matt



nickel matt

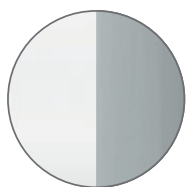

white matt/
chrome



black matt/
chrome

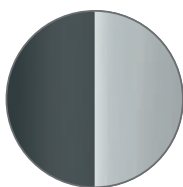

anthracite matt/
chrome

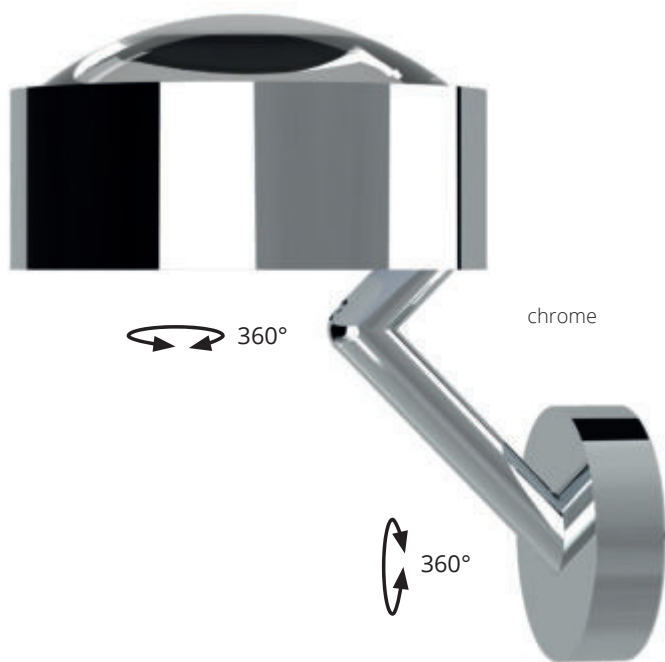

Puk Meg Maxx Next LED G ~2.700k	Puk Meg Maxx Next G9 Fassung	Kopf ø Head ø in mm	Gehäuse body
downlight 1 x 16W, ~1.200lm	downlight		
2-50721	2-50721-H	160	chrome matt
2-50722	2-50722-H	160	chrome
2-50723	2-50723-H	160	nickel matt
2-50722-22	2-50722-H-22	160	white matt/chr.
2-50722-02	2-50722-H-02	160	black matt/chr.
2-50722-23	2-50722-H-23	160	anthracite matt/chr.
up- & downlight 2 x 16W, ~2.400lm	up- & downlight		
2-50731	2-50731-H	160	chrome matt
2-50732	2-50732-H	160	chrome
2-50733	2-50733-H	160	nickel matt
2-50732-22	2-50732-H-22	160	white matt/chr.
2-50732-02	2-50732-H-02	160	black matt/chr.
2-50732-23	2-50732-H-23	160	anthracite matt/chr.

▶ Ohne Zubehör. Bestell-Artikelnummern für Linse, Glas, Farbfilter und die Konfigurationsempfehlung auf der Einklappseite!

▶ Without accessories: Order item-no. for lens, glass, color filter and the recommended Configuration are on the fold-in page!

G9 max. 33W ECO, optional LED Retrofit

G9 max. 33W ECO, LED Retrofit optional

Leuchtmittelempfehlung: LED max. 3W/300lm/2.700K/dimmbar

bulb recommendation: LED max. 3W/300Lm/2.700K/dimmable

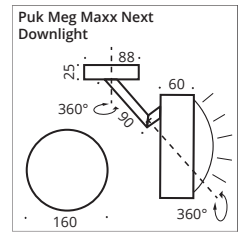
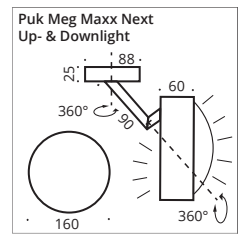
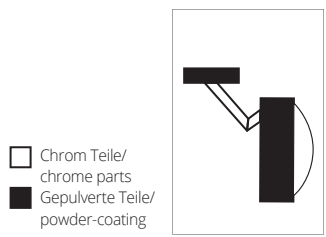



Puk Flexlight Double Wall



Puk Mini Flexlight Wall ø 80

Kombinieren Sie den Puk-Kopf mit Flexarm und Ihrer Wunschbasis, Gläser/Linsen und Farbfilter werden separat dazubestellt. Hochvolt Halogen oder LED.

Combine the Puk - head with flex arm and your desired base. Glasses/lenses and colour filters need to be ordered separately in addition. High voltage or LED.

INDOOR



Puk Flexlight Wall LED G 2 x 8W ~1.200lm ~2.700k	Puk Flexlight Wall G9 Fassung	Puk Flexlight Double Wall LED G 4 x 8W ~2.400lm ~2.700k	Puk Flexlight Double Wall G9 Fassung	Armlänge arm length in mm	Gehäuse body
3-4020114-LED	3-4020114	3-4120114-LED	3-4120114	200	chrome
3-4020214-LED	3-4020214	3-4120214-LED	3-4120214	200	nickel matt
3-4030114-LED	3-4030114	3-4130114-LED	3-4130114	300	chrome
3-4030214-LED	3-4030214	3-4130214-LED	3-4130214	300	nickel matt

▶ Ohne Zubehör. Bestell-Artikelnummern für Linse, Glas, Farbfilter und die Konfigurationsempfehlung auf der Einklappeseite!



▶ Without accessories: Order item-no. for lens, glass, color filter and the recommended Configuration are on the fold-in page!

G9 max. 33W, optional LED Retrofit
 G9 max. 33W, LED Retrofit optional

Leuchtmittelpfehlung: LED max. 3W/300lm/2.700K/dimmbar **G** Art Nr. 8-205
 bulb recommendation: LED max. 3W/300Lm/2.700K/dimmable **G** Item No. 8-205

ABC (s.S 6-7/s.p. 6-7)

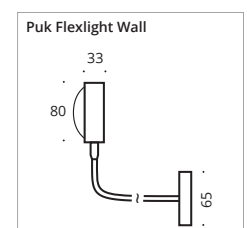



Puk Choice Mirror





Puk Mini Choice Mirror/Wall ø 80

Lichtbalken in verschiedenen Längen, bestückt mit Halogen oder LED Puk Köpfen. Zur Montage direkt an die Wand.

Light bar in various lengths for direct wall mounting. Equipped with Halogen or LED Puk Wall luminaires.



chrome

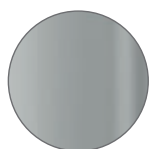

chrome matt



nickel matt

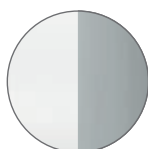

white matt/
chrome



black matt/
chrome

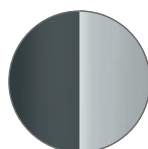

anthracite matt/
chrome

INDOOR

G9 Fassung

450 mm L 2 Köpfe/heads	800 mm L 3 Köpfe/heads	1.000 mm L 4 Köpfe/heads	1.200 mm L 4 Köpfe/heads	Gehäuse body
8-604021-H	8-608041-H	8-6010041-H	8-6012041-H	chrome matt chrome nickel matt white matt/chrome black matt/chrome anthracite matt/chr.
8-604022-H	8-608042-H	8-6010042-H	8-6012042-H	
8-604023-H	8-608043-H	8-6010043-H	8-6012043-H	
8-604022-H-22	8-608042-H-22	8-6010042-H-22	8-6012042-H-22	
8-604022-H-02	8-608042-H-02	8-6010042-H-02	8-6012042-H-02	
8-604022-H-23	8-608042-H-23	8-6010042-H-23	8-6012042-H-23	

- ▶ Ohne Zubehör. Bestell-Artikelnummern für Linse, Glas, Farbfilter und die Konfigurationsempfehlung auf der Einklappseite!
- ▶ Without accessories: Order item-no. for lens, glass, color filter and the recommended Configuration are on the fold-in page!



Farbig gepulverter Lichtbalken auf Anfrage. Color powdered metal rail on request.

G9 max. 33W ECO, optional LED Retrofit | G9 max. 33W ECO, LED Retrofit optional

Leuchtmittelempfehlung: LED max. 3W/300lm/2.700K/dimmbar **G** Art Nr. 8-205
bulb recommendation: LED max. 3W/300Lm/2.700K/dimmable **G** Item No. 8-205

LED

450 mm L 2 Köpfe/heads G	800 mm L 3 Köpfe/heads G	1.000 mm L 4 Köpfe/heads G	1.200 mm L 4 Köpfe/heads G	Gehäuse body
4 x 8W, ~2.400lm, ~2.700k	6 x 8W, ~3.600lm, ~2.700k	8 x 8W, ~4.800lm, ~2.700k	8 x 8W, ~4.800lm, ~2.700k	chrome matt chrome nickel matt white matt/chrome black matt/chrome anthracite matt/chr.
8-604021	8-608041	8-6010041	8-6012041	
8-604022	8-608042	8-6010042	8-6012042	
8-604023	8-608043	8-6010043	8-6012043	
8-604022-22	8-608042-22	8-6010042-22	8-6012042-22	
8-604022-02	8-608042-02	8-6010042-02	8-6012042-02	
8-604022-23	8-608042-23	8-6010042-23	8-6012042-23	

- ▶ Ohne Zubehör. Bestell-Artikelnummern für Linse, Glas, Farbfilter und die Konfigurationsempfehlung auf der Einklappseite!
- ▶ Without accessories: Order item-no. for lens, glass, color filter and the recommended Configuration are on the fold-in page!



Farbig gepulverter Lichtbalken auf Anfrage. Color powdered metal rail on request.

Sonderanfertigung:
Art-Nr. 8-600 Kürzung auf Maß
Item No. 8-600 Customized lengths

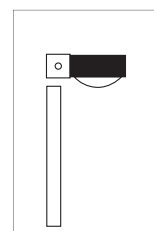
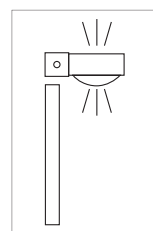
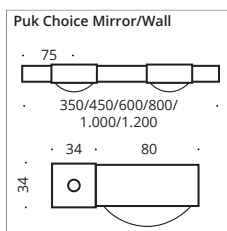

□ Chrom Teile/
chrome parts
■ Gepulverte Teile/
powder-coating





Puk Mini Choice Mirror/Wall »+« Ø 80

Lichtbalken in verschiedenen Längen, bestückt mit Halogen oder LED Puk Wall Köpfen. Zur Montage mit Abstandhalter-Röhrchen, um eine direktere Spiegelbeleuchtung zu ermöglichen. Einseitig mit LED-Stripes illuminiertes Metall Profil.

Light bars in various lengths, equipped with halogen or LED Puk Wall heads. For mounting with spacer tubes to allow direct mirror lighting. Metal profile illuminated on one side with LED stripes.



chrome

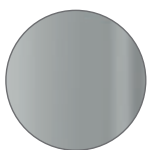

chrome matt



nickel matt



white matt/
chrome

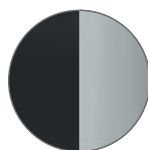

black matt/
chrome

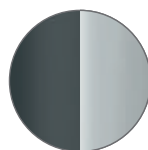

anthracite matt/
chrome

G9 Fassung

450 mm L 2 Köpfe/heads LED 9W	800 mm L 3 Köpfe/heads LED 13,5W	1.000 mm L 4 Köpfe/heads LED 22,5W	1.200 mm L 4 Köpfe/heads LED 22,5W	Gehäuse body
8-604021-H/+ 8-604022-H/+ 8-604023-H/+ 8-604022-H/+22 8-604022-H/+02 8-604022-H/+23	8-608041-H/+ 8-608042-H/+ 8-608043-H/+ 8-608042-H/+22 8-608042-H/+02 8-608042-H/+23	8-6010041-H/+ 8-6010042-H/+ 8-6010043-H/+ 8-6010042-H/+22 8-6010042-H/+02 8-6010042-H/+23	8-6012041-H/+ 8-6012042-H/+ 8-6012043-H/+ 8-6012042-H/+22 8-6012042-H/+02 8-6012042-H/+23	chrome matt chrome nickel matt white matt/chrome black matt/chrome anthracite matt/chr.

- ▶ Ohne Zubehör. Bestell-Artikelnummern für Linse, Glas, Farbfilter und die Konfigurationsempfehlung auf der Einklappseite!
- ▶ Without accessories: Order item-no. for lens, glass, color filter and the recommended Configuration are on the fold-in page!



Farbig gepulverter Lichtbalken auf Anfrage. Color powdered metal rail on request.

G9 max. 33W ECO, optional LED Retrofit | G9 max. 33W ECO, LED Retrofit optional

Leuchtmittelempfehlung: LED max. 3W/300lm/2.700K/dimmbar **G** Art Nr. 8-205
bulb recommendation: LED max. 3W/300Lm/2.700K/dimmable **G** Item No. 8-205

LED

450 mm L 2 Köpfe/heads G 4 x 8W, ~2.400lm, ~2.700k LED 9W	800 mm L 3 Köpfe/heads G 6 x 8W, ~3.600lm, ~2.700k LED 13,5W	1.000 mm L 4 Köpfe/heads G 8 x 8W, ~4.800lm, ~2.700k LED 22,5W	1.200 mm L 4 Köpfe/heads G 8 x 8W, ~4.800lm, ~2.700k LED 22,5W	Gehäuse body
8-604021/+ 8-604022/+ 8-604023/+ 8-604022/+22 8-604022/+02 8-604022/+23	8-608041/+ 8-608042/+ 8-608043/+ 8-608042/+22 8-608042/+02 8-608042/+23	8-6010041/+ 8-6010042/+ 8-6010043/+ 8-6010042/+22 8-6010042/+02 8-6010042/+23	8-6012041/+ 8-6012042/+ 8-6012043/+ 8-6012042/+22 8-6012042/+02 8-6012042/+23	chrome matt chrome nickel matt white matt/chrome black matt/chrome anthracite matt/chr.

- ▶ Ohne Zubehör. Bestell-Artikelnummern für Linse, Glas, Farbfilter und die Konfigurationsempfehlung auf der Einklappseite!
- ▶ Without accessories: Order item-no. for lens, glass, color filter and the recommended Configuration are on the fold-in page!



Farbig gepulverter Lichtbalken auf Anfrage. Color powdered metal rail on request.

Sonderanfertigung:

Art-Nr. 8-600 Kürzung auf Maß

Item No. 8-600 Customized lengths

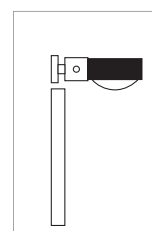
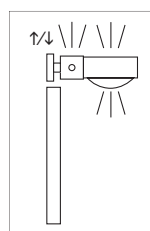
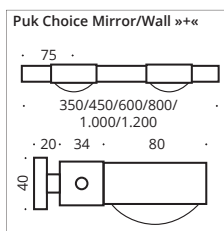

□ Chrom Teile/
chrome parts
■ Gepulverte Teile/
powder-coating

INDOOR





Focus 100

100 mm breite Wandleuchte in chrom oder nickelmatt, wahlweise in LED- oder Hochvolt Halogen Ausführung, alle dimmbar.

100 mm wide wall lamp in chrome or nickel matt, available in LED or high voltage halogen design, all dimmable.

INDOOR



chrome

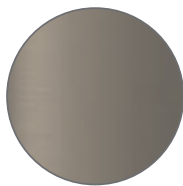

nickel matt

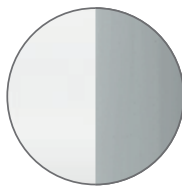

white matt/
chrome

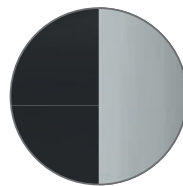

black matt/
chrome

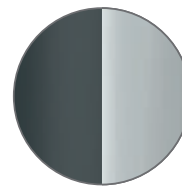

anthracite matt/
chrome

LED	G9 Fassung	Gehäuse body
2 x 8W ~1.200lm ~2.700k		
2-101001-LED	2-101001	nickel matt
2-101002-LED	2-101002	chrome
2-101002-LED-22	2-101002-22	white matt/chrome
2-101002-LED-02	2-101002-02	black matt/chrome
2-101002-LED-23	2-101002-23	anthracite matt/chrome

▶ Ohne Zubehör. Bestell-Artikelnummern für Linse, Glas und Farbfilter auf Seite 159!
▶ Without accessories: Order item-no. for lens, glass and color filter are on page 159!

G9 max. 33W ECO, optional LED Retrofit
 G9 max. 33W ECO, LED Retrofit optional

Leuchtmittelempfehlung: LED max. 3W/300lm/2.700K/dimmbar Art Nr. 8-205
 bulb recommendation: LED max. 3W/300Lm/2.700K/dimmable Item No. 8-205

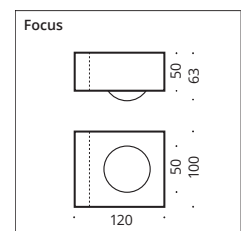





Focus 150

150 mm breite Wandleuchte in chrom oder nickelmatt, wahlweise in LED- oder Hochvolt Halogen Ausführung, alle dimmbar.

150 mm wide wall lamp in chrome or nickel matt, available in LED or high voltage halogen design, all dimmable.

INDOOR



chrome

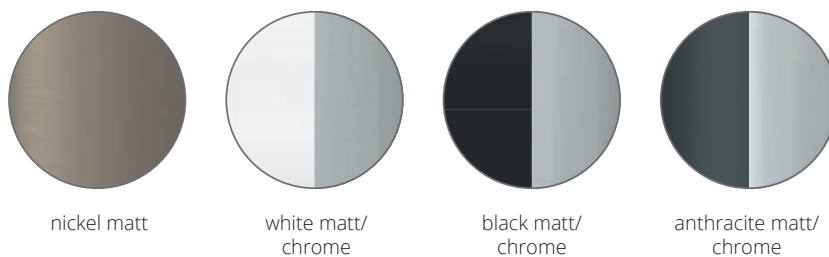

nickel matt

white matt/
chrome

black matt/
chrome

anthracite matt/
chrome

LED	G9 Fassung	Gehäuse body
G ~2.700k		
2-101501-LED 2 x 8W ~1.200lm	2-101501 1 x LS	nickel matt
2-101502-LED 2 x 8W ~1.200lm	2-101502 1 x LS	chrome
2-101502-LED-22 2 x 8W ~1.200lm	2-101502-22 1 x LS	white matt/chrome
2-101502-LED-02 2 x 8W ~1.200lm	2-101502-02 1 x LS	black matt/chrome
2-101502-LED-23 2 x 8W ~1.200lm	2-101502-23 1 x LS	anthracite matt/chrome
2-101503-LED 4 x 4W ~1.200lm	2-101503 2 x LS	nickel matt
2-101504-LED 4 x 4W ~1.200lm	2-101504 2 x LS	chrome
2-101504-LED-22 4 x 4W ~1.200lm	2-101504-22 2 x LS	white matt/chrome
2-101504-LED-02 4 x 4W ~1.200lm	2-101504-02 2 x LS	black matt/chrome
2-101504-LED-23 4 x 4W ~1.200lm	2-101504-23 2 x LS	anthracite matt/chrome
	2-101505 3 x LS	nickel matt
	2-101506 3 x LS	chrome
	2-101506-22 3 x LS	white matt/chrome
	2-101506-02 3 x LS	black matt/chrome
	2-101506-23 3 x LS	anthracite matt/chrome

▶ Ohne Zubehör. Bestell-Artikelnummern für Linse, Glas und Farbfilter auf Seite 159!
▶ Without accessories: Order item-no. for lens, glass and color filter are on page 159!

G9 max. 33W ECO, optional LED Retrofit
 G9 max. 33W ECO, LED Retrofit optional

Leuchtmittelempfehlung: LED max. 3W/300lm/2.700K/dimmbar **G** Art Nr. 8-205
 bulb recommendation: LED max. 3W/300Lm/2.700K/dimmable **G** Item No. 8-205

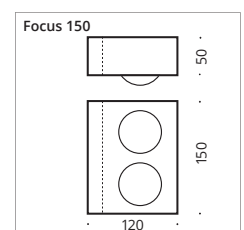





Focus Equipment

Linsen, Gläser, Farbfilter und Spiegelhalter frei zu kombinieren.

Lenses, glasses, colour filters and mirror holders can be freely combined.

INDOOR



Art. Nr. item no.	Einsatz insert	Beschreibung description
2-625	Alurefektor, aluminium baffle	Lichtstopp, empfohlen unter Glas Lightstop, recommended under glass
2-626	Linse, lens	klar, clear
2-626-s	Linse, lens	einseitig mattiert, frosted on one side
2-627	Glas, glass	beidseitig mattiert, passt nicht unter Linse frosted on both sides, doesn't fit under lens
2-628 2-629 2-630 2-633 2-634	Farbfilter, color filter	rot, red magenta, magenta gelb, yellow blau, blue grün, green
2-1201	Spiegelhalter	Klemmmontage am Spiegel, Spring mounting on mirror

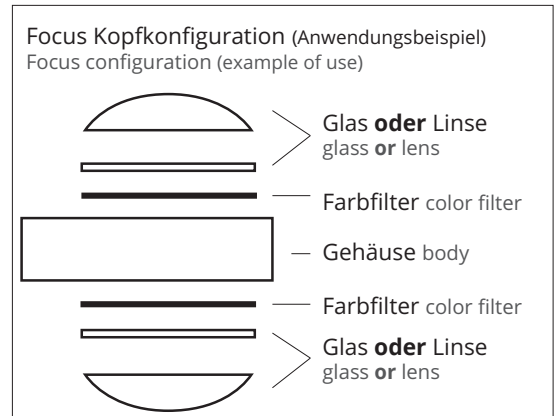

rot, red

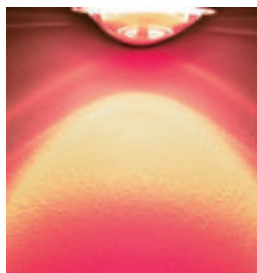

magenta, magenta

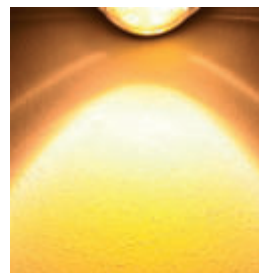

gelb, yellow



blau, blue

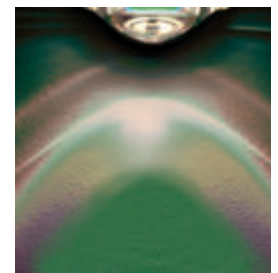

grün, green





Allround ø 120/160/240

Diese Aufbauleuchte wurde für den Wand- und Deckeneinsatz konstruiert, dimmbar. Mit zwei kardanisch aufeinander abgestimmten Gelenken, lassen sich die LED Leuchtenköpfe um über 360 Grad drehen. Mit drei Leuchtenkopfdurchmessern (ø120mm/8W/920lm, ø160mm/12W/1300lm, ø240mm/16W/1600lm, durchgängig 2700k), sind die Leuchten für viele Anwendungen im Privat- oder Objektbereich planbar.

This surface-mounted luminaire was designed for wall and ceiling use, dimmable. With two gimbal-mounted joints, the LED luminaire heads can be rotated through more than 360 degrees. With three luminaire head diameters (ø120mm/8W/920lm, ø160mm/12W/1300lm, ø240mm/16W/1600lm, 2700k throughout all models), the luminaires can be integrated for many applications in the residential and project sector.

INDOOR

Allround in Bewegung (Wandbefestigung) Allround in motion (wall mounting)



Allround in Bewegung (Deckenbefestigung) Allround in motion (ceiling mounting)



chrome

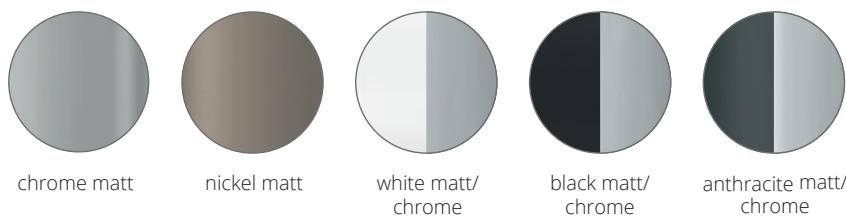

Allround 120 mm ø	Allround 160 mm ø	Allround 240 mm ø	Gehäuse body
LED: G 8 Watt, ~2.700k ~920 lm	LED: G 12 Watt, ~2.700k ~1.300 lm	LED: G 16 Watt, ~2.700k ~1.600 lm	
● 7-2201211	7-2201611	7-2202411	chrome matt
● 7-2201212	7-2201612	7-2202412	chrome
● 7-2201213	7-2201613	7-2202413	nickel matt
● 7-2201212-22	7-2201612-22	7-2202412-22	white matt/chrome
● 7-2201212-02	7-2201612-02	7-2202412-02	black matt/chrome
● 7-2201212-23	7-2201612-23	7-2202412-23	anthracite matt/chr.

- Chrom Teile/
chrome parts
- Gepulverte Teile/
powder-coating

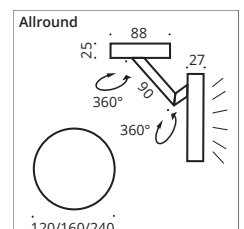
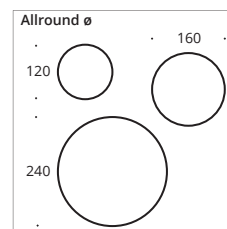
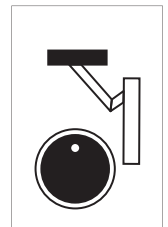





Only Choice Wall

Geradlinige LED Leuchte für die Direktmontage mit Prismen-
diffusor. Für den Objekt- und Privatbereich der Officeanwen-
dung.

Linear LED luminaire for direct mounting with prismatic dif-
fuser. For project and residential use.

INDOOR

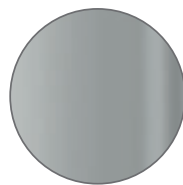

chrome matt

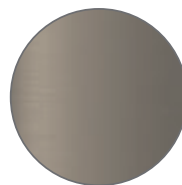

nickel matt

chrome



Only Choice Direktmontage

350 mm L	600 mm L	800 mm L	1.250 mm L	Gehäuse body
LED: G 9W, ~720lm, ~3.000k	LED: G 13,5W, ~1080lm, ~3.000k	LED: G 22,5W, ~1800lm, ~3.000k	LED: G 36W, ~2880lm, ~3.000k	
8-601351	8-601651	8-601951	8-6011251	chrome matt
8-601352	8-601652	8-601952	8-6011252	chrome
8-601353	8-601653	8-601953	8-6011253	nickel matt

Farbig gepulverter Lichtbalken auf Anfrage. Color powdered metal rail on request.

Bitte hinter die Art.-Nr. den Buchstaben (D-F) der gewünschten Decken- oder
Wandvariante hängen. Durch Versetzen der Endkappen ist jede Variante montierbar.
Please attach the character (D-F) to the item no. of the ceiling or wall variant you have
chosen. With turning the endpieces the lamp can be mounted in every possibility D-F.

C (s.S 6-7/s.p. 6-7)

Sonderanfertigung:
Art-Nr. 8-600 Kürzung auf Maß
Item No. 8-600 Customized lengths

Montagevarianten:

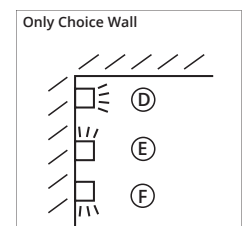
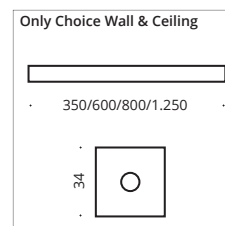





Only Choice Wall »+«

Geradlinige LED Leuchte für die Direktmontage mit Prismen-
diffusor. Für den Objekt- und Privatbereich der Officeanwen-
dung.

Linear LED luminaire for direct mounting with prismatic dif-
fuser. For project and residential use.

INDOOR

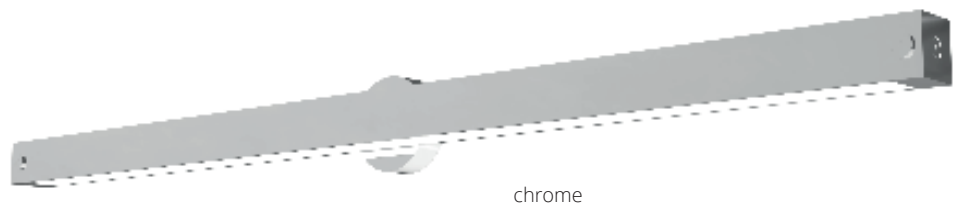

chrome

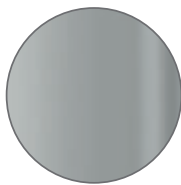

chrome matt

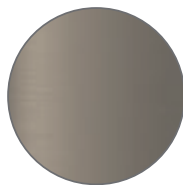

nickel matt

Only Choice »+« Rohr montierbar auf Abstand

350 mm L	600 mm L	800 mm L	1.250 mm L	Gehäuse body
LED: G 9W, ~720lm, ~3.000k	LED: G 13,5W, ~1080lm, ~3.000k	LED: G 22,5W, ~1800lm, ~3.000k	LED: G 36W, ~2880lm, ~3.000k	
8-602351	8-602651	8-602951	8-6021251	chr. matt
8-602352	8-602652	8-602952	8-6021252	chrome
8-602353	8-602653	8-602953	8-6021253	nick. matt

Farbig gepulverter Lichtbalkenauf Anfrage. Color powdered metal rail on request.

Bitte hinter die Art.-Nr. den Buchstaben (K-M) der gewünschten Wandvariante hängen.
Durch Versetzen der Endkappen ist jede Variante montierbar.

Please attach the character (K-M) to the item no. of the wall variant you have chosen.
With turning the endpieces the lamp can be mounted in every possibility K-M.



Sonderanfertigung:

Art-Nr. 8-600 Kürzung auf Maß

Item No. 8-600 Customized lengths

Montagevarianten:

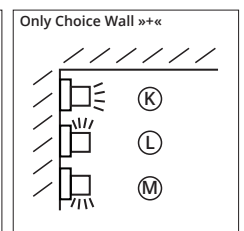
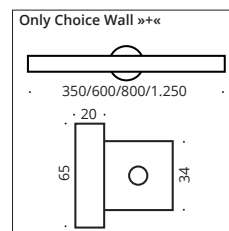



Lichtstange



Lichtstange

Erhältlich als Wandleuchte, mit LED-Röhre 1-sockelig in opal, optional mit Kippschalter, Wandabstand 70 mm. Als Lichtstange mit Klemmbefestigung zur Montage am Spiegel, mit transparentem Kabel, Schalter und Stecker, Leuchtmittel LED (8W).

Available as wall luminaire with LED tube 1-socket in opal. Optionally with flip switch, wall distance 70 mm. As a light bar with clip fastening for mounting on the mirror, with transparent cable, switch and plug. Light source LED (8W).

INDOOR

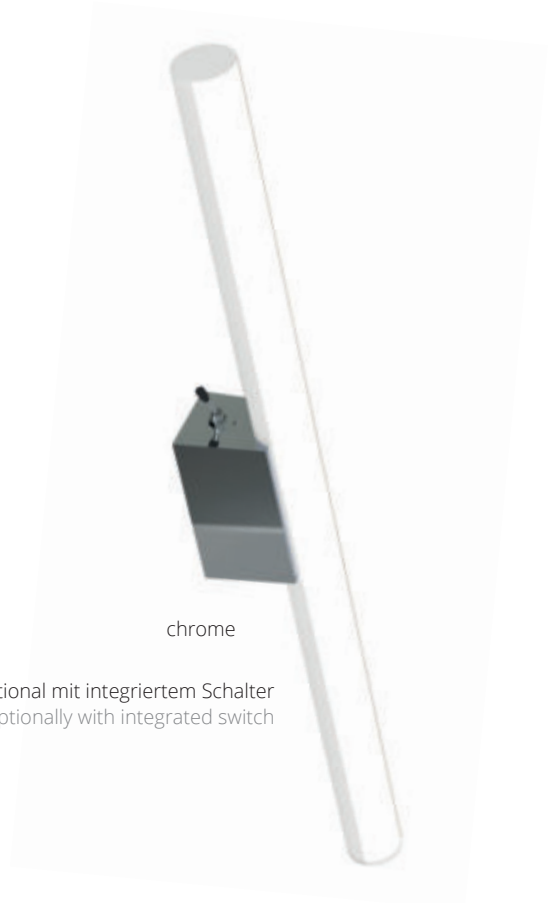
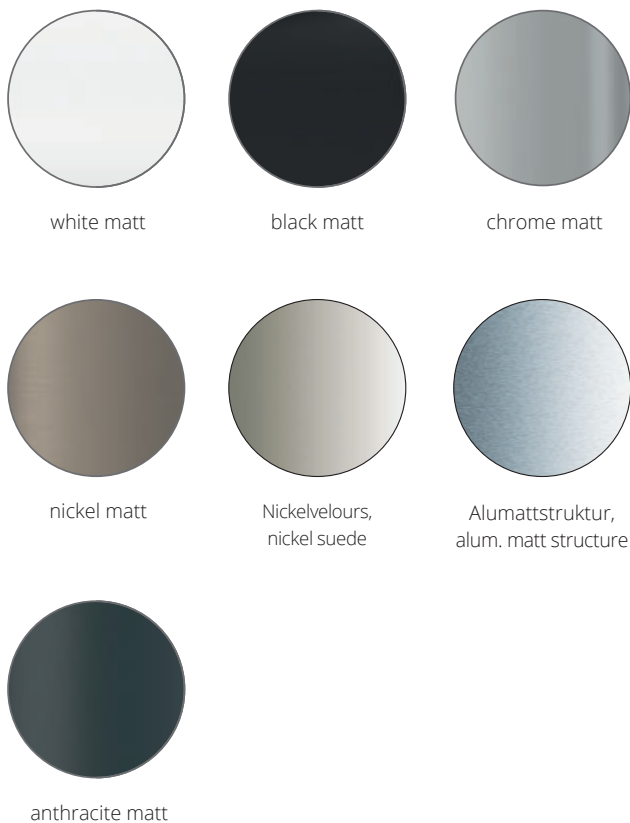

LED	LED	Ausführung design
S14D Sockel ohne Leuchtmittel without lamp	G 8W ~700lm, ~2.700k	
● 2-0302	2-0302-LED	chrome
● 2-0302-WE	2-0302-LED-WE	white matt
● 2-0302-BE	2-0302-LED-BE	black matt
● 2-0301	2-0301-LED	chrome matt
● 2-0309	2-0309-LED	nickel matt
● 2-0303	2-0303-LED	nickel suede
● 2-0304	2-0304-LED	alum. matt texture
● 2-0302-23	2-0302-LED-23	anthracite matt

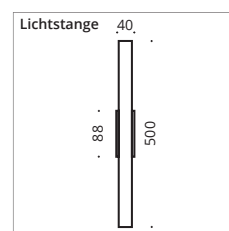

CE LED C IP20 C (s.S 6-7/s.p. 6-7)

Für einen integr. Schalter hängen Sie bitte ein -K hinter die Art.-Nr.
Please attach -K behind the item-no. for an integrated switch.



Two Socket Base



Two Socket

Gerade richtig ist die extra lange Wandleuchte für den Spiegeleinsatz und zur Ausleuchtung von Bildern.

Just right is the extra long wall lamp for mirror use and for illuminating pictures.

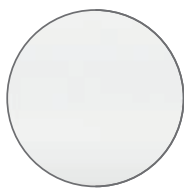

white matt

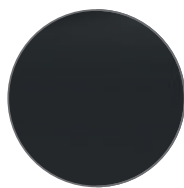

black matt

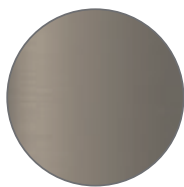

nickel matt

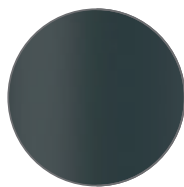

anthracite matt



Two Socket chrome



Two Socket Base chrome

INDOOR

Modell model	LED S14D Socket ohne Leuchtmittel without lamp	LED G 16W, ~1.450lm, ~3.000k	Ausführung design	Beschreibung specification
<ul style="list-style-type: none"> ● Two Socket ● ● ● ● 	<ul style="list-style-type: none"> 2-0402 2-0409 2-0402-22 2-0402-02 2-0402-23 	<ul style="list-style-type: none"> 2-0402-LED 2-0409-LED 2-0402-LED-22 2-0402-LED-02 2-0402-LED-23 	<ul style="list-style-type: none"> chrome nickel matt white matt black matt anthracite matt 	<ul style="list-style-type: none"> Wandleuchte, 2-sockelig, maximal 120 Watt Wall lamp, 2 bases, max.120 watts
<ul style="list-style-type: none"> ● Two Socket Base ● ● ● ● 	<ul style="list-style-type: none"> 2-0422 2-0429 2-0422-22 2-0422-02 2-0422-23 	<ul style="list-style-type: none"> 2-0422-LED 2-0429-LED 2-0422-LED-22 2-0422-LED-02 2-0422-LED-23 	<ul style="list-style-type: none"> chrome nickel matt white matt black matt anthracite matt 	<ul style="list-style-type: none"> Wandleuchte mit Grundplatte, 2-sockelig, max. 120 Watt Wall lamp with base plate, 2 bases, max.120 watts

Für einen integr. Schalter hängen Sie bitte ein -K hinter die Art.-Nr.
Please attach -K behind the item-no. for an integrated switch.

Two Socket: Two Socket Base: C (s.S 6-7/s.p. 6-7)

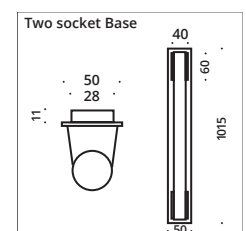





Hotel Duo

Wandleuchte mit Doppelfunktion. Der feste Arm mit farbigem Schirm bietet angenehmes, indirektes Licht. Der Spot mit Flexarm und Rio-Kopf bringt das Licht dahin, wo man es benötigt, z. B. als Leseleuchte am Bett.

Wall lamp with a dual function. The fixed arm combined with a colored shade provides indirect pleasant light. The flexible arm with a Rio Head can be adjusted wherever the light is needed. E.g. as a bedside lamp.

Artikelnr. Beispiel für abgebildete Leuchte. Example of item-no. for the lamp pictured.

24-170201 + SI-100R = 24-170201-SI-100R

Hotel Duo

Schirm E14
Spot GU10

Gehäuse
body

24-170201- + Schirm s. unten
+ shade s. below

nickel matt

Für einen integr. Schalter hängen Sie bitte ein -K hinter die Art.-Nr.
Please attach -K behind the item-no. for an integrated switch.

Leuchtmittelangabe E14

E14 max 20W; opt. LED

Leuchtmittlempfehlung

Art. Nr. 8-524

LED ~6W ~470lm ~2.700k

Leuchtmittelangabe GU10

GU10 max 35W; opt. LED

Leuchtmittlempfehlung

Art. Nr. 8-211

LED ~4W ~230lm ~2.700k

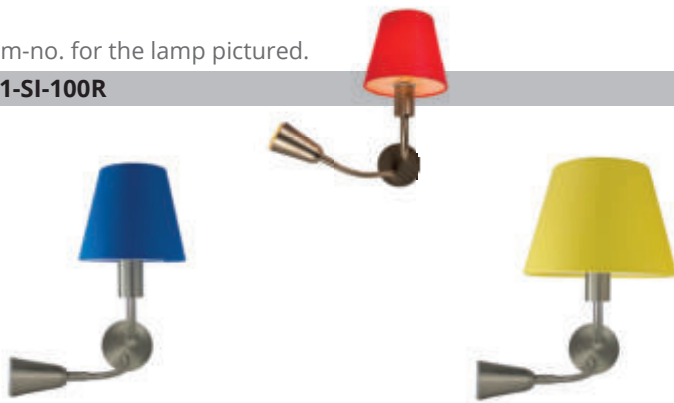

Schirmfarben für Silk (Chinz) Shade colors for Silk (Chinz)

- SI-100DB
- SI-100RO
- SI-100HB
- SI-100GB
- SI-100TK
- SI-100GR
- SI-100O
- SI-100V
- SI-100S
- SI-100W
- SI-100R
- SI-100GU
- SI-100BR
- SI-100OL

Schirmfarben für Speed (Chinz) Shade colors for Speed (Chinz)

- SP-100DB
- SP-100RO
- SP-100HB
- SP-100GB
- SP-100TK
- SP-100GR
- SP-100O
- SP-100V
- SP-100S
- SP-100W
- SP-100R
- SP-100GU
- SP-100BR
- SP-100OL



Schirmfarben für Brick (Chinz) Shade colors for Brick (Chinz)

- BR-100DB
- BR-100RO
- BR-100HB
- BR-100GB
- BR-100TK
- BR-100GR
- BR-100O
- BR-100V
- BR-100S
- BR-100W
- BR-100R
- BR-100GU
- BR-100BR
- BR-100OL

Schirmfarben für Game (Chinz) Shade colors for Game (Chinz)

- GA-100DB
- GA-100RO
- GA-100HB
- GA-100GB
- GA-100TK
- GA-100GR
- GA-100O
- GA-100V
- GA-100S
- GA-100W
- GA-100R
- GA-100GU
- GA-100BR
- GA-100OL

Schirmfarben für Wheel (Chinz) Shade colors for Wheel (Chinz)

- WE-100DB
- WE-100RO
- WE-100HB
- WE-100GB
- WE-100TK
- WE-100GR
- WE-100O
- WE-100V
- WE-100S
- WE-100W
- WE-100R
- WE-100GU
- WE-100BR
- WE-100OL

Sonderanfertigungen möglich:

Ab 10 Stück ist die Fertigung von Sonderfarben möglich oder z. B.:

- innen gold- oder silber kaschierte Schirme
 - Lackschirme
 - Seidenschirme
- Die Schirme werden per Hand gefertigt. Dadurch sind bestimmte individuelle Wünsche realisierbar.

Customized Shades are possible:

From 10 lamps up special requirements are available:

- golden or silver concealed shades
 - lacquer shades
 - silk shades
- All shades are handmade. Individual requirements can be realized.

BC (s.S 6-7/s.p. 6-7)

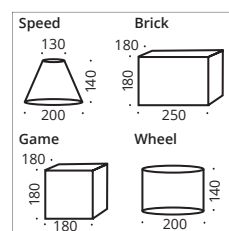
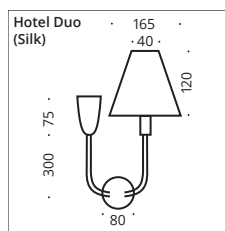

INDOOR





Flexlight Wall & Double Wall



Iglo

India

Pisa

Rio



Silk Double Wall

INDOOR

Iglo Wall	India Wall	Pisa Wall	Silk Wall	Rio Wall	Armlänge arm length in mm	Ausführung design
G9 ohne Leuchtmittel without lamp	G9 ohne Leuchtmittel without lamp	G9 ohne Leuchtmittel without lamp	E14 ohne Leuchtmittel without lamp	GU10 ohne Leuchtmittel without lamp		
3-4020101	3-4020102	3-4020103	3-4020105	3-4020117	200	chrome
3-4020201	3-4020202	3-4020203	3-4020205	3-4020217	200	nickel matt
3-4030101	3-4030102	3-4030103	3-4030105	3-4030117	300	chrome
3-4030201	3-4030202	3-4030203	3-4030205	3-4030217	300	nickel matt
3-4040101	3-4040102	3-4040103	3-4040105	3-4040117	400	chrome
3-4040201	3-4040202	3-4040203	3-4040205	3-4040217	400	nickel matt

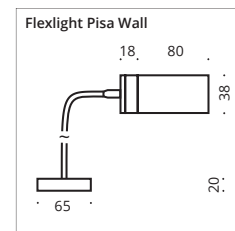

Iglo Double Wall	India Double Wall	Pisa Double Wall	Silk Double Wall	Rio Double Wall	Armlänge arm length in mm	Ausführung design
G9 ohne Leuchtmittel without lamp	G9 ohne Leuchtmittel without lamp	G9 ohne Leuchtmittel without lamp	E14 ohne Leuchtmittel without lamp	GU10 ohne Leuchtmittel without lamp		
3-4120101	3-4120102	3-4120103	3-4120105	3-4120117	200	chrome
3-4120201	3-4120202	3-4120203	3-4120205	3-4120217	200	nickel matt
3-4130101	3-4130102	3-4130103	3-4130105	3-4130117	300	chrome
3-4130201	3-4130202	3-4130203	3-4130205	3-4130217	300	nickel matt
3-4140101	3-4140102	3-4140103	3-4140105	3-4140117	400	chrome
3-4140201	3-4140202	3-4140203	3-4140205	3-4140217	400	nickel matt

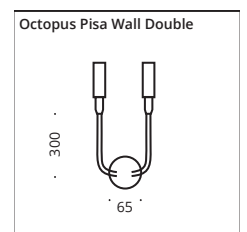

<ul style="list-style-type: none"> G9 max. 33W ECO, optional LED Retrofit G9 max. 33W ECO, LED Retrofit optional 	Leuchtmittlempfehlung: LED max. 3W/300lm/2.700K/dimmbar G Art Nr. 8-205 bulb recommendation: LED max. 3W/300Lm/2.700K/dimmable G Item No. 8-205
<ul style="list-style-type: none"> E14 max. 20W, optional LED Retrofit E14 max. 20W, LED Retrofit optional 	Leuchtmittlempfehlung: LED max. 6W/470lm/2.700K G Art. Nr. 8-524 bulb recommendation: LED max. 6W/470Lm/2.700K G Item No. 8-524
<ul style="list-style-type: none"> GU10 max. 35W, optional LED Retrofit GU10 max. 35W, LED Retrofit optional 	Leuchtmittlempfehlung: LED max. 4W/230lm/2.700K G Art. Nr. 8-211 bulb recommendation: LED max. 4W/230Lm/2.700K G Item No. 8-211

Umbau zum Spiegeleinbau, conversion for mirror mounting
 180° Reflektor optional für Glas Pisa, 180° baffle optional for glass Pisa
 "Touch me" Dimmer, "Touch me" dimmer
 Kippschalereinbau, dip switch fitting
 Weitere Schirm-Farben für die Silk finden Sie auf der Einklappseite. You can find more colors for the silk shades on the fold in page.

Art.-Nr. 9-3002 chrom (chrome), Art.-Nr. 9-3009 nickelmatt (nickel matt)
 Art.-Nr. 9-204
 Art.-Nr. -D
 Art.-Nr. -K



Glasslight Wall Pisa Double



Glass- & Spotlight Wall

INDOOR



Iglo



Pisa



Pisa Double IP44



India



Rio



Pisa Double



Bulb

Iglo G9 ohne Leuchtmittel without lamp	India G9 ohne Leuchtmittel without lamp	Pisa G9 ohne Leuchtmittel without lamp	Rio GU10 ohne Leuchtmittel without lamp	Ausführung design
2-400101 2-400201	2-400102 2-400202	2-400103 2-400203	2-400117 2-400217	chrome nickel matt



Pisa Double G9 ohne Leuchtmittel without lamp	Pisa Double IP44 G9 ohne Leuchtmittel without lamp	Bulb G9 ohne Leuchtmittel without lamp	Ausführung design
2-400130 2-400230	2-400130 IP44 2-400230 IP44	2-400132 2-400232	chrome nickel matt

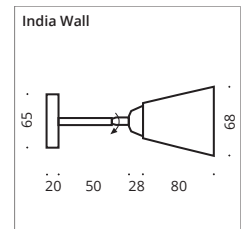
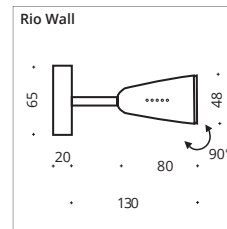

G9 max. 33W ECO, optional LED Retrofit G9 max. 33W ECO, LED Retrofit optional	Leuchtmittelempfehlung: LED max. 3W/300lm/2.700K/dimmbar G Art. Nr. 8-205 bulb recommendation: LED max. 3W/300lm/2.700K/dimmable G Item No. 8-205
GU10 max. 35W, optional LED Retrofit GU10 max. 35W, LED Retrofit optional	Leuchtmittelempfehlung: LED max. 4W/230lm/2.700K G Art. Nr. 8-211 bulb recommendation: LED max. 4W/230lm/2.700K G Item No. 8-211

Umbau zum Spiegeleinbau, conversion for mirror mounting Art.-Nr. 9-3002 chrom (chrome), 9-3009 nickelmatt (nickel matt)
 180° Reflektor optional für Glas Pisa, 180° baffle optional for glass Pisa Art.-Nr. 9-204
 "Touch me" Dimmer, "Touch me" dimmer Art.-Nr. -D
 Kippschalereinbau, dip switch fitting Art.-Nr. -K



STECKERLEUCHTEN

PLUG LAMPS



Puk Mini Fexlight Plug 179



Glass- & Spotlight Flex 181



Glass- & Spotlight Plug 183



Puk Mini Flexlight Plug



Puk Mini Flexlight Plug

Die praktische Plugleuchte mit Pukkopf ist überall dort einsetzbar, wo eine Steckdose ist. Die Gläser/Linsen und Farbfilter werden separat dazubestellt.

The convenient plug light with Puk head can be used wherever there is a power socket. Glasses/Lenses and color filters for separate order.

INDOOR

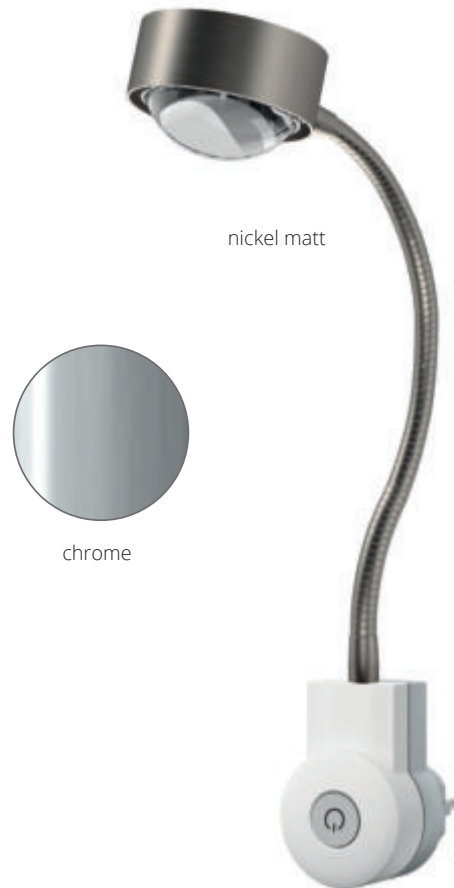

Puk Flexlight LED 2 x 8W ~1.200lm ~2.700k	Puk Flexlight G9 Fassung	Armlänge arm length in mm	Gehäuse body
3-3220114-LED	3-3220114	200	chrome
3-3220214-LED	3-3220214	200	nickel matt
3-3230114-LED	3-3230114	300	chrome
3-3230214-LED	3-3230214	300	nickel matt
3-3240114-LED	3-3240114	400	chrome
3-3240214-LED	3-3240214	400	nickel matt

▶ Ohne Zubehör. Bestell-Artikelnummern für Linse, Glas, Farbfilter und die Konfigurationsempfehlung auf der Einklapppseite!

▶ Without accessories: Order item-no. for lens, glass, color filter and the recommended Configuration are on the fold-in page!

G9 max. 33W ECO, optional LED Retrofit
 G9 max. 33W ECO, LED Retrofit optional

Leuchtmittelpfehlung: LED max. 3W/300lm/2.700K/dimmbar Art Nr. 8-205
 bulb recommendation: LED max. 3W/300lm/2.700K/dimmable Item No. 8-205

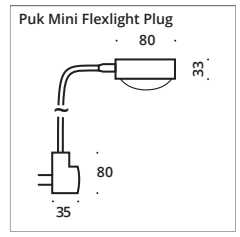





Flexlight Plug

INDOOR



Iglo



India



Pisa



Rio



Silk

	Iglo G9 ohne Leuchtmittel without lamp	India G9 ohne Leuchtmittel without lamp	Pisa G9 ohne Leuchtmittel without lamp	Silk E14 ohne Leuchtmittel without lamp	Rio GU10 ohne Leuchtmittel without lamp	Armlänge arm length in mm	Ausführung design
●	3-3220101	3-3220102	3-3220103	3-3220105	3-3220117	200	chrome
●	3-3220201	3-3220202	3-3220203	3-3220205	3-3220217	200	nickel matt
●	3-3230101	3-3230102	3-3230103	3-3230105	3-3230117	300	chrome
●	3-3230201	3-3230202	3-3230203	3-3230205	3-3230217	300	nickel matt
●	3-3240101	3-3240102	3-3240103	3-3240105	3-3240117	400	chrome
●	3-3240201	3-3240202	3-3240203	3-3240205	3-3240217	400	nickel matt

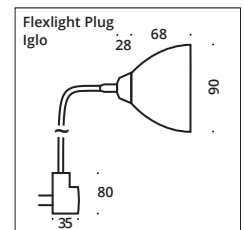

C (s.S 6-7/s.p. 6-7)

G9 max. 33W ECO, optional LED Retrofit G9 max. 33W ECO, LED Retrofit optional	Leuchtmittlempfehlung: LED max. 3W/300lm/2.700K/dimmbar Art. Nr. 8-205 bulb recommendation: LED max. 3W/300Lm/2.700K/dimmable Item No. 8-205
E14 max. 20W, optional LED Retrofit E14 max. 20W, LED Retrofit optional	Leuchtmittlempfehlung: LED max. 6W/470lm/2.700K Art. Nr. 8-524 bulb recommendation: LED max. 6W/470Lm/2.700K Item No. 8-524
GU10 max. 35W, optional LED Retrofit GU10 max. 35W, LED Retrofit optional	Leuchtmittlempfehlung: LED max. 4W/230lm/2.700K Art. Nr. 8-211 bulb recommendation: LED max. 4W/230Lm/2.700K Item No. 8-211

180° Reflektor optional für Glas Pisa, 180° baffle optional for glass Pisa Art.-Nr. 9-204

Weitere Schirm-Farben für die Silk finden Sie auf der Einklappseite. You can find more colors for the silk shades on the fold-in page.





Glass- & Spotlight Plug

INDOOR



Pisa



Rio



Bulb

Pisa	Rio	Bulb	Ausführung design
G9 ohne Leuchtmittel without lamp	GU10 ohne Leuchtmittel without lamp	G9 ohne Leuchtmittel without lamp	
2-320103 2-320203	2-320117 2-320217	2-320132 2-320232	chrome nickel matt
			C (s.S 6-7/s.p. 6-7)

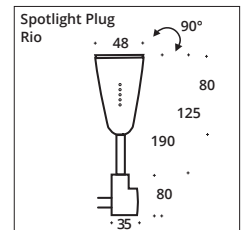

G9 max. 33W ECO, optional LED Retrofit
 G9 max. 33W ECO, LED Retrofit optional

Leuchtmittlempfehlung: LED max. 3W/300lm/2.700K/dimmbar Art Nr. 8-205
 bulb recommendation: LED max. 3W/300Lm/2.700K/dimmable Item No. 8-205

GU10 max. 35W, optional LED Retrofit
 GU10 max. 35W, LED Retrofit optional

Leuchtmittlempfehlung: LED max. 4W/230lm/2.700K
 bulb recommendation: LED max. 4W/230Lm/2.700K Art. Nr. 8-211
 Item No. 8-211

180° Reflektor optional für Glas Pisa, 180° baffle optional for glass Pisa Art.-Nr. 9-204



Puk Maxx Long Double

PENDELLEUCHTEN

PENDULAR LAMPS



Puk Mini Long One 187
Puk Maxx Long One 189
Puk Meg Maxx Long One 191



Puk Mini Long Double 187
Puk Maxx Long Double 189



Puk Mini Drop 193
Puk Maxx Drop 195
Puk Meg Maxx Drop 197



Puk Mini Quartett 199
Puk Maxx Quartett 201



Puk Mini Sixtett 199
Puk Maxx Sixtett 201



Puk Mini Choice Long One 203
Puk Maxx Choice Long One 205



Puk Mini Choice Drop 207
Puk Maxx Choice Drop 209



Puk Mini Crown S 211
Puk Maxx Crown S 211



Puk Mini Crown M 213
Puk Maxx Crown M 213



Puk Mini Crown L 215
Puk Maxx Crown L 215



Puk Mini Crown XL 217
Puk Maxx Crown XL 217



Puk Mini Line S 219
Puk Maxx Line S 219



Puk Mini Line M 221
Puk Maxx Line M 221



Puk Mini Line L 223
Puk Maxi Line L 223



Sun Swing 225



Choice Sun Swing 227



Foxx Swing 229



Pela 231
Pela Quadro 231



Pela Choice 233
Pela Quadro Choice 233



Look at me 235
Look at me Trio 235



Look at me Choice 237



Puk Mini Long Double



Puk Mini Long One & Long Double \varnothing 80

Pendelleuchte, Hochvolt Halogen oder LED Power, dimmbar. Pendellänge ca. 1.300 mm, Standard-Textilkabel in anthrazit.

Pendant luminaire, high voltage halogen or LED power, with one or two heads, dimmable. Pendant length approx. 1,300 mm. Textile cable in anthracite as standard.

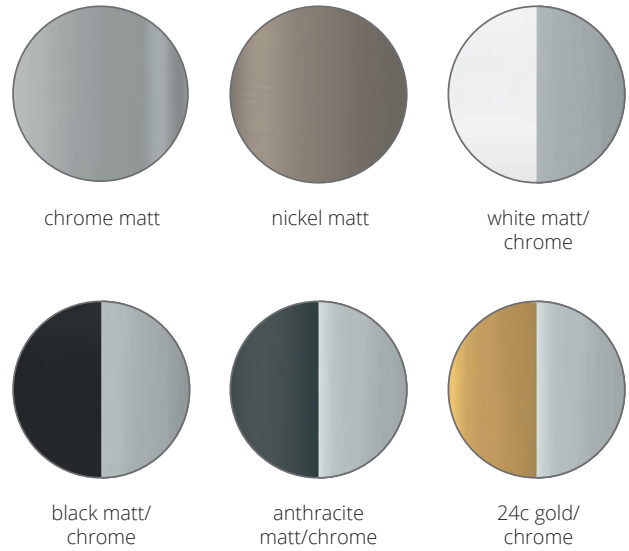

INDOOR

Puk Mini Long LED G ~2.700k, 1/4 x 8W	Puk Mini Long G9 Fassung	B x Pendellänge mm w x pendular length mm	Gehäuse body
One ~600lm downlight	One downlight		
5-08001-1-LED	5-08001-1	80 x 1.300	chrome matt
5-08002-1-LED	5-08002-1	80 x 1.300	chrome
5-08003-1-LED	5-08003-1	80 x 1.300	nickel matt
5-08002-1-LED-22	5-08002-1-22	80 x 1.300	white matt/ chrome
5-08002-1-LED-02	5-08002-1-02	80 x 1.300	black matt/ chrome
5-08002-1-LED-23	5-08002-1-23	80 x 1.300	anthracite/ chrome
5-08006-1-LED	5-08006-1	80 x 1.300	24 carat gold plated/chr.
Double ~2.400lm up- & downlight	Double up- & downlight		
5-08001-2-LED	5-08001-2	200 x 1.300	chrome matt
5-08002-2-LED	5-08002-2	200 x 1.300	chrome
5-08003-2-LED	5-08003-2	200 x 1.300	nickel matt
5-08002-2-LED-22	5-08002-2-22	200 x 1.300	white matt/ chrome
5-08002-2-LED-02	5-08002-2-02	200 x 1.300	black matt/ chrome
5-08002-2-LED-23	5-08002-2-23	200 x 1.300	anthracite/ chrome
5-08006-2-LED	5-08006-2	200 x 1.300	24 carat gold plated/chr.



Optional Kabelvarianten. Optional cable.



Chrom Teile/ chrome parts
 Gepulverte Teile/ powder-coating

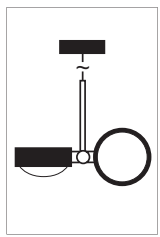
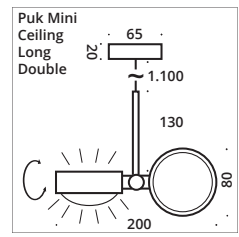
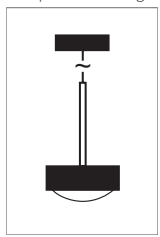
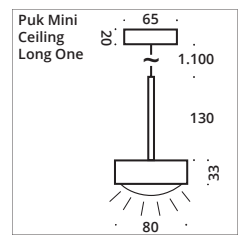

5-07951 Kabelverlängerung lfd. Meter cable extension per meter

▶ Ohne Zubehör. Bestell-Artikelnummern für Linse, Glas, Farbfilter und die Konfigurationsempfehlung auf der Einklappseite!

▶ Without accessories: Order item-no. for lens, glass, color filter and the recommended Configuration are on the fold-in page!

G9 max. 33W, optional LED Retrofit
 G9 max. 33W, LED Retrofit optional

Leuchtmittelempfehlung: LED max. 3W/300lm/2.700K/dimmbar **G** Art Nr. 8-205
 bulb recommendation: LED max. 3W/300lm/2.700K/dimmable **G** Item No. 8-205

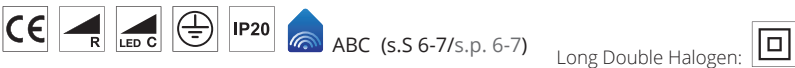

Long Double Halogen:





Puk Maxx Long One & Long Double \varnothing 120

Pendelleuchte, Hochvolt Halogen oder LED Power, mit ein oder zwei Köpfen dimmbar. Pendellänge ca. 1.300 mm, Standard-Textilkabel in anthrazit.

Pendant luminaire, high voltage halogen or LED power, with one or two heads, dimmable. Pendant length approx. 1,300 mm. Textile cable in anthracite as standard.



chrome

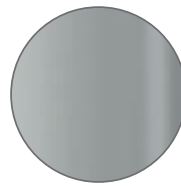

chrome matt

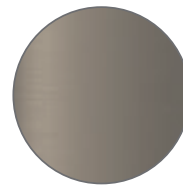

nickel matt

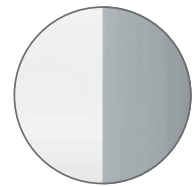

white matt/
chrome

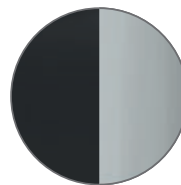

black matt/
chrome

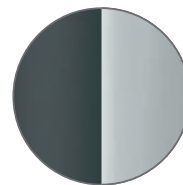

anthracite matt/
chrome

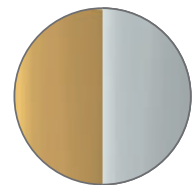

24c gold/
chrome

INDOOR

Puk Maxx LED G ~2.700k 1/4 x 12W	Puk Maxx G9 Fassung	B x Pendel- länge in mm w x pendular length in mm	Gehäuse body
Long One ~900lm, downlight	Long One up- & downlight		
5-38001	5-38001-H	120 x 1.300	chrome matt
5-38002	5-38002-H	120 x 1.300	chrome
5-38003	5-38003-H	120 x 1.300	nickel matt
5-38002-22	5-38002-H-22	120 x 1.300	white matt/chrome
5-38002-02	5-38002-H-02	120 x 1.300	black matt/chrome
5-38002-23	5-38002-H-23	120 x 1.300	anthracite/chrome
5-38006	5-38006-H	120 x 1.300	24 carat gold plated/chr.
Long Double ~3.600lm	Long Double		
5-38021	5-38021-H	280 x 1.300	chrome matt
5-38022	5-38022-H	280 x 1.300	chrome
5-38023	5-38023-H	280 x 1.300	nickel matt
5-38022-22	5-38022-H-22	280 x 1.300	white matt/chrome
5-38022-02	5-38022-H-02	280 x 1.300	black matt/chrome
5-38022-23	5-38022-H-23	280 x 1.300	anthracite/chrome
5-38026	5-38026-H	280 x 1.300	24 carat gold plated/chr.

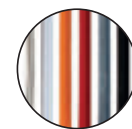

Optional Kabelvarianten.
Optional cable.



Chrom Teile/
chrome parts
 Gepulverte Teile/
powder-coating

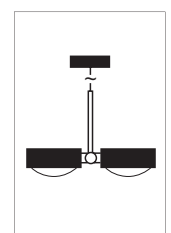
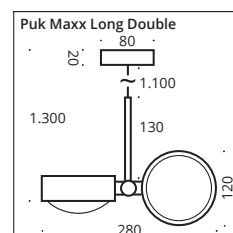
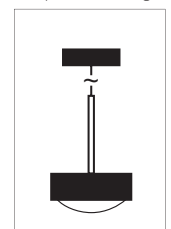
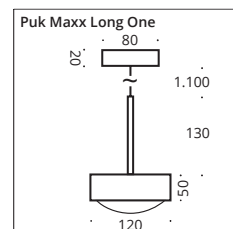

5-07951 Kabelverlängerung lfd. Meter cable extension per meter

▶ Ohne Zubehör. Bestell-Artikelnummern für Linse, Glas, Farbfilter und die Konfigurationsempfehlung auf der Einklappseite!



▶ Without accessories: Order item-no. for lens, glass, color filter and the recommended Configuration are on the fold-in page!

G9 max. 33W, optional LED Retrofit

G9 max. 33W, LED Retrofit optional

Leuchtmittelempfehlung: LED max. 3W/300lm/2.700K/dimmbar **G** Art Nr. 8-205
bulb recommendation: LED max. 3W/300Lm/2.700K/dimmable **G** Item No. 8-205



ABC (s.S 6-7/s.p. 6-7)





Puk Meg Maxx Long One ø 160

Pendelleuchte, Hochvolt Halogen oder LED Power, dimmbar, mit Metallabdeckung »up«. »Down« optional bestückbar mit Linse oder Glas. Pendellänge ca. 1.300 mm, Standard-Textilkabel in anthrazit.

Pendant luminaire, high voltage halogen or LED power, dimmable. with metal cover "up". "Down" can be optionally equipped with lens or glass. Pendant length approx. 1,300 mm. Textile cable in anthracite as standard.

INDOOR

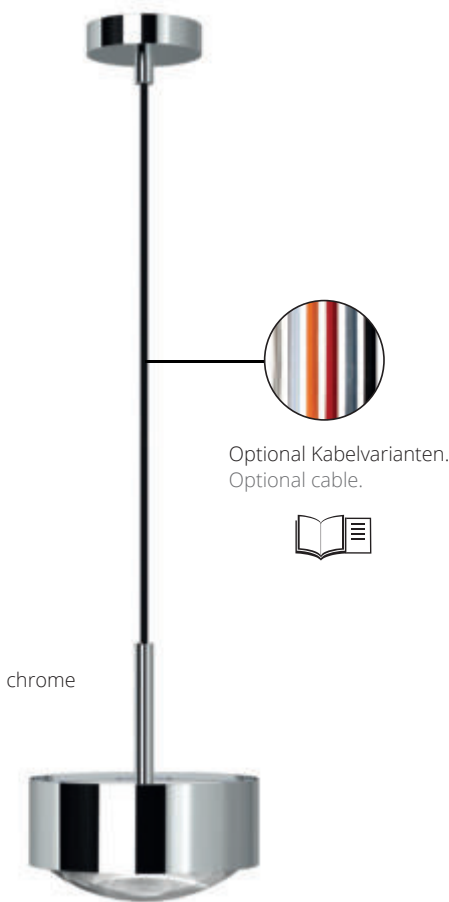
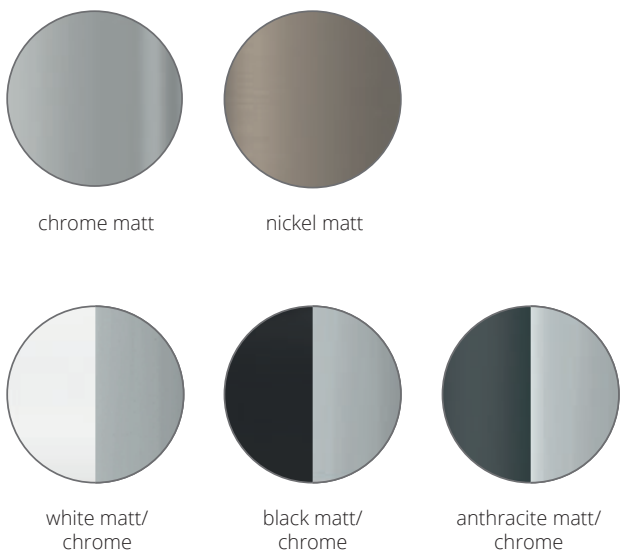

Puk Meg Maxx Long One LED	Puk Meg Maxx Long One G9 Fassung	Kopf ø head ø in mm	Gehäuse body
LED: G 16W ~2.400lm ~2.700k			
5-50001	5-50001-H	160	chrome matt
5-50002	5-50002-H	160	chrome
5-50003	5-50003-H	160	nickel matt
5-50002-22	5-50002-H-22	160	white matt/chr.
5-50002-02	5-50002-H-02	160	black matt/chr.
5-50002-23	5-50002-H-23	160	anthracite matt/chr.

5-07951 Kabelverlängerung 1 m, Cable extension 1 m

▶ Ohne Zubehör. Bestell-Artikelnummern für Linse, Glas, Farbfilter und die Konfigurationsempfehlung auf der Einklappseite!



▶ Without accessories: Order item-no. for lens, glass, color filter and the recommended Configuration are on the fold-in page!

G9 max. 33W, optional LED Retrofit

G9 max. 33W, LED Retrofit optional

Leuchtmittelpfehlung: LED max. 3W/300lm/2.700K/dimmbar **G** Art Nr. 8-205
 bulb recommendation: LED max. 3W/300Lm/2.700K/dimmable **G** Item No. 8-205



Chrom Teile/
chrome parts
 Gepulverte Teile/
powder-coating

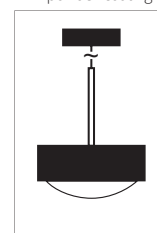
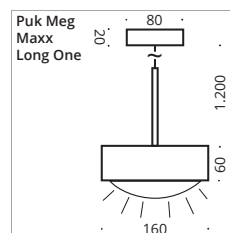



Puk Mini Drop Trio



Puk Mini Drop ø 80

Pendelleuchte mit einem oder drei Köpfen. Erhältlich in LED oder Halogen. Pendellänge ca. 1.300 mm, Standard-Textilkabel in anthrazit.

Pendant luminaire with one or 3 heads. Available in high-voltage halogen or LED. Pendant length approx. 1,300 mm. Textile cable in anthracite as standard.

Puk Mini Drop Solo

Puk Drop LED G 2 x 8W, ~600lm ~2.700k	Puk Drop G9 Fassung	Kopf ø Head ø in mm	Gehäuse body
5-06001	5-06001-H	80	chrome matt
5-06002	5-06002-H	80	chrome
5-06003	5-06003-H	80	nickel matt
5-06002-22	5-06002-H-22	80	white matt/chr.
5-06002-02	5-06002-H-02	80	black matt/chr.
5-06002-23	5-06002-H-23	80	anthracite matt/chr.
5-07951 Kabelverlängerung 1 m, cable extension 1 m			
▶ Ohne Zubehör. Bestell-Artikelnummern für Linse, Glas, Farbfilter und die Konfigurationsempfehlung auf der Einklappseite!			
▶ Without accessories: Order item-no. for lens, glass, color filter and the recommended Configuration are on the fold-in page!			
G9 max. 33W, optional LED Retrofit			
G9 max. 33W, LED Retrofit optional			
LME: LED max. 3W/300lm/2.700K/dimmbar G Art Nr. 8-205			
bulb recom.: LED max. 3W/300Lm/2.700K/dimmable G Item No. 8-205			

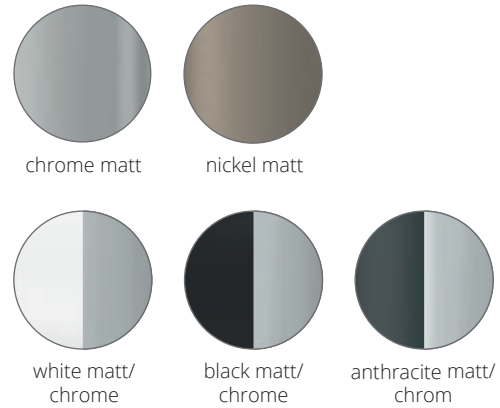

Puk Mini Drop Trio

Puk Drop LED G 6x 8W, ~1.800lm ~2.700k	Puk Drop G9 Fassung	Baldachin ø Baldachin ø in mm	Gehäuse body
5-060031	5-060031-H	200	chrome matt
5-060032	5-060032-H	200	chrome
5-060033	5-060033-H	200	nickel matt
5-060032-22	5-060032-H-22	200	white matt/chr.
5-060032-02	5-060032-H-02	200	black matt/chr.
5-060032-23	5-060032-H-23	200	anthracite matt/chr.
5-07953 Kabelverlängerung 3 x 1 m, cable extension 3 x 1 m			
▶ Ohne Zubehör. Bestell-Artikelnummern für Linse, Glas, Farbfilter und die Konfigurationsempfehlung auf der Einklappseite!			
▶ Without accessories: Order item-no. for lens, glass, color filter and the recommended Configuration are on the fold-in page!			
G9 max. 33W, optional LED Retrofit			
G9 max. 33W, LED Retrofit optional			
LME: LED max. 3W/300lm/2.700K/dimmbar G Art Nr. 8-205			
bulb recom.: LED max. 3W/300Lm/2.700K/dimmable G Item No. 8-205			

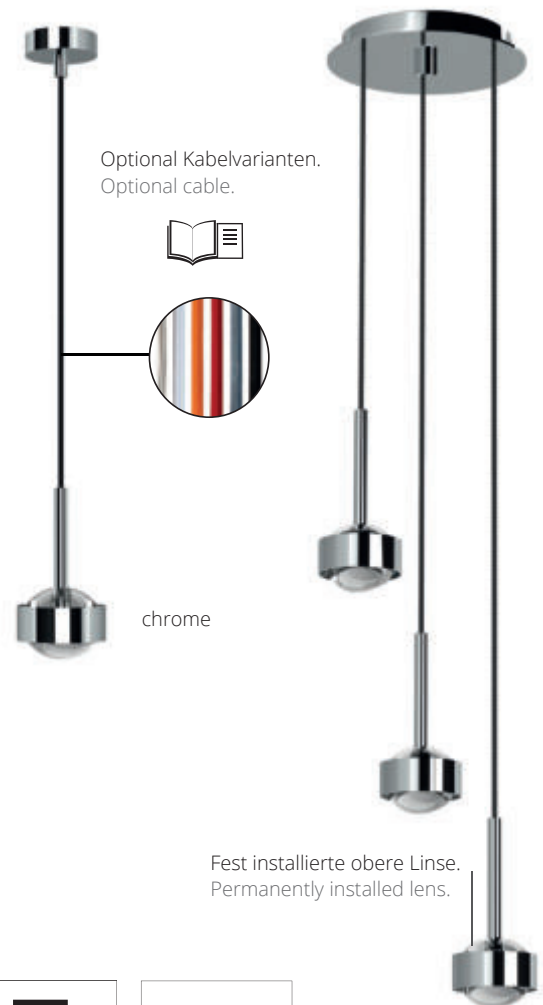

ABCD (s.S 6-7/s.p. 6-7)

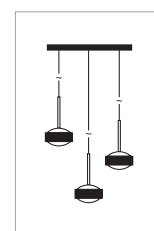
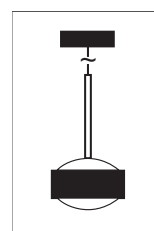
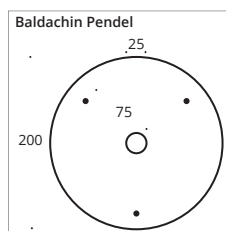
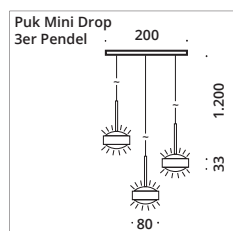
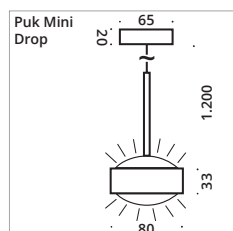

Chrom Teile/chrome parts
 Gepulverte Teile/powder-coating

INDOOR





Puk Maxx Drop ø 120

Pendelleuchte mit einem oder drei Köpfen. Erhältlich in LED oder Halogen. Pendellänge ca. 1.300 mm, Standard-Textilkabel in anthrazit.

Pendant luminaire with one or 3 heads. Available in high-voltage halogen or LED. Pendant length approx. 1,300 mm. Textile cable in anthracite as standard.

INDOOR

Puk Maxx Drop Solo

Puk Maxx Drop LED G 2 x 12W, ~1.800lm ~2.700k	Puk Maxx Drop G9 Fassung	Kopf ø Head ø in mm	Gehäuse body
5-36001	5-36001-H	120	chrome matt
5-36002	5-36002-H	120	chrome
5-36003	5-36003-H	120	nickel matt
5-36002-22	5-36002-H-22	120	white matt/chr.
5-36002-02	5-36002-H-02	120	black matt/chr.
5-36002-23	5-36002-H-23	120	anthracite matt/chr.

5-07951 Kabelverlängerung 1 m, cable extension 1 m

▶ Ohne Zubehör. Bestell-Artikelnummern für Linse, Glas, Farbfilter und die Konfigurationsempfehlung auf der Einklappseite!

▶ Without accessories: Order item-no. for lens, glass, color filter and the recommended Configuration are on the fold-in page!

G9 max. 33W, optional LED Retrofit
 G9 max. 33W, LED Retrofit optional

LME: LED max. 3W/300lm/2.700K/dimmbar **G** Art Nr. 8-205
 bulb recom.: LED max. 3W/300Lm/2.700K/dimmable **G** Item No. 8-205

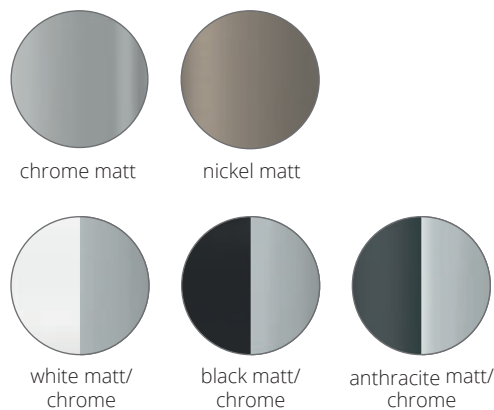

Puk Maxx Drop Trio

Puk Maxx Drop LED G 6 x 12W, ~5.400lm, ~2.700k	Puk Maxx Drop G9 Fassung	Baldachin ø Baldachin ø in mm	Gehäuse body
5-360031	5-360031-H	200	chrome matt
5-360032	5-360032-H	200	chrome
5-360033	5-360033-H	200	nickel matt
5-360032-22	5-360032-H-22	200	white matt/chr.
5-360032-02	5-360032-H-02	200	black matt/chr.
5-360032-23	5-360032-H-23	200	anthracite matt/chr.

5-07953 Kabelverlängerung 3 x 1 m, cable extension 3 x 1 m

▶ Ohne Zubehör. Bestell-Artikelnummern für Linse, Glas, Farbfilter und die Konfigurationsempfehlung auf der Einklappseite!

▶ Without accessories: Order item-no. for lens, glass, color filter and the recommended Configuration are on the fold-in page!

G9 max. 33W, optional LED Retrofit
 G9 max. 33W, LED Retrofit optional

LME: LED max. 3W/300lm/2.700K/dimmbar **G** Art Nr. 8-205
 bulb recom.: LED max. 3W/300Lm/2.700K/dimmable **G** Item No. 8-205



ABCD (s.S 6-7/s.p. 6-7)

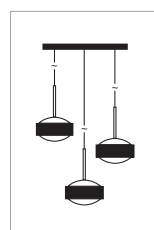
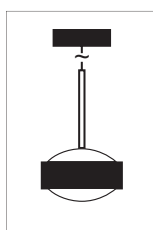
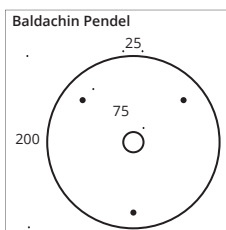
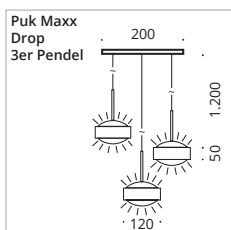
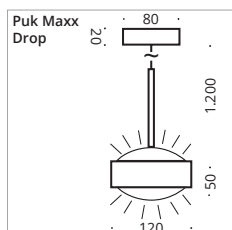

Chrom Teile/chrome parts
 Gepulverte Teile/powder-coating



Puk Meg Maxx Drop Trio



Puk Meg Maxx Drop ø 160

Pendelleuchte mit einem oder drei Köpfen. Erhältlich in LED oder mit G9 Fassung für den Einsatz von LED Retrofit oder Halogen. Pendellänge ca. 1.300 mm, Standard-Textilkabel in anthrazit.

Pendant luminaire with one or 3 heads. Available in LED or with G9 socket for the use of LED retrofit or halogen luminaires. Pendant length approx. 1,300 mm. Textile cable in anthracite as standard.

INDOOR

Puk Meg Maxx Drop Solo

Puk Meg Maxx Drop LED G 2 x 16W ~2.400lm ~2.700k	Puk Meg Maxx Drop G9 Fassung	Kopf ø Head ø in mm	Gehäuse body
5-56001	5-56001-H	160	chrome matt
5-56002	5-56002-H	160	chrome
5-56003	5-56003-H	160	nickel matt
5-56002-22	5-56002-H-22	160	white matt/chr.
5-56002-02	5-56002-H-02	160	black matt/chr.
5-56002-23	5-56002-H-23	160	anthracite/chr.
5-07951 Kabelverlängerung 1 m, cable extension 1 m			

▶ Ohne Zubehör. Bestell-Artikelnummern für Linse, Glas, Farbfilter und die Konfigurationsempfehlung auf der Einklappseite!
 ▶ Without accessories: Order item-no. for lens, glass, color filter and the recommended Configuration are on the fold-in page!

G9 max. 33W, optional LED Retrofit
 G9 max. 33W, LED Retrofit optional
 LME: LED max. 3W/300lm/2.700K/dimmbar Art Nr. 8-205
 bulb recom.: LED max. 3W/300Lm/2.700K/dimmable Item No. 8-205

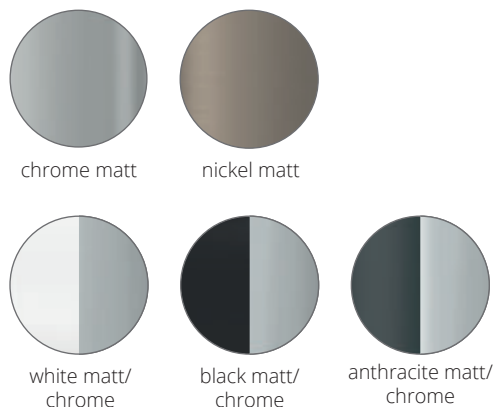

Puk Meg Maxx Drop Trio

Puk Meg Maxx Drop LED G 6 x 16W ~7.200lm ~2.700k	Puk Meg Maxx Drop G9 Fassung	Baldachin ø Baldachin ø in mm	Gehäuse body
5-560031	5-560031-H	200	chrome matt
5-560032	5-560032-H	200	chrome
5-560033	5-560033-H	200	nickel matt
5-560032-22	5-560032-H-22	200	white matt/chr.
5-560032-02	5-560032-H-02	200	black matt/chr.
5-560032-23	5-560032-H-23	200	anthracite/chr.
5-07953 Kabelverlängerung 3 x 1 m, cable extension 3 x 1 m			

▶ Ohne Zubehör. Bestell-Artikelnummern für Linse, Glas, Farbfilter und die Konfigurationsempfehlung auf der Einklappseite!
 ▶ Without accessories: Order item-no. for lens, glass, color filter and the recommended Configuration are on the fold-in page!

G9 max. 33W, optional LED Retrofit
 G9 max. 33W, LED Retrofit optional
 LME: LED max. 3W/300lm/2.700K/dimmbar Art Nr. 8-205
 bulb recom.: LED max. 3W/300Lm/2.700K/dimmable Item No. 8-205



CE R LED C IP20 ABCD (s.S 6-7/s.p. 6-7)

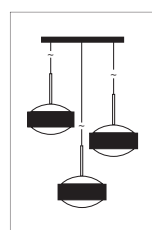
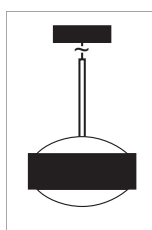
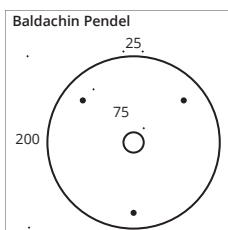
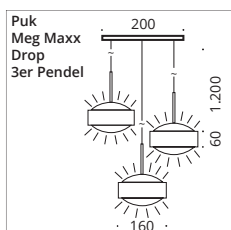
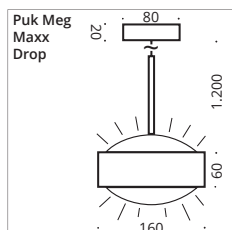

□ Chrom Teile/chrome parts
 ■ Gepulverte Teile/powder-coating





Puk Mini Quartett & Puk Sixtett ø 80

Pendelleuchte, Hochvolt Halogen oder LED Power, dimmbar. Pendellänge ca. 1.300 mm, Standard-Textilkabel in anthrazit.

Pendant luminaire in high voltage halogen or LED Power, dimmable. Pendant length approx. 1,300 mm. Textile cable in anthracite as standard.

INDOOR



chrome

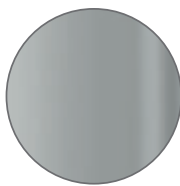

chrome matt

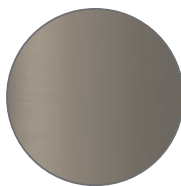

nickel matt

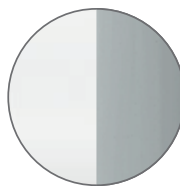

white matt/
chrome

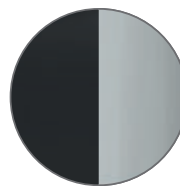

black matt/
chrome

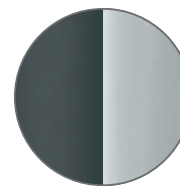

anthracite matt/
chrome

Puk Mini LED G ~2.700k	Puk Mini G9 Fassung	L x Pendellänge l x pendular length in mm	Gehäuse body
Quartett 8 x 8W, ~4.800lm	Quartett		
5-07801-4-LED	5-07801-4	805 x 2.000	chrome matt
5-07802-4-LED	5-07802-4	805 x 2.000	chrome
5-07803-4-LED	5-07803-4	805 x 2.000	nickel matt
5-07802-4-LED-22	5-07802-4-22	805 x 2.000	white matt/chr.
5-07802-4-LED-02	5-07802-4-02	805 x 2.000	black matt/chr.
5-07802-4-LED-23	5-07802-4-23	805 x 2.000	anthracite matt/chr.
Sixtett 12 x 8W, ~7.200lm	Sixtett		
5-071201-6-LED	5-071201-6	1.260 x 2.000	chrome matt
5-071202-6-LED	5-071202-6	1.260 x 2.000	chrome
5-071203-6-LED	5-071203-6	1.260 x 2.000	nickel matt
5-071202-6-LED-22	5-071202-6-22	1.260 x 2.000	white matt/chr.
5-071202-6-LED-02	5-071202-6-02	1.260 x 2.000	black matt/chr.
5-071202-6-LED-23	5-071202-6-23	1.260 x 2.000	anthracite matt/chr.



Optional Kabelvarianten.
Optional cable.



► Ohne Zubehör. Bestell-Artikelnummern für Linse, Glas, Farbfilter und die Konfigurationsempfehlung auf der Einklappseite!

► Without accessories: Order item-no. for lens, glass, color filter and the recommended Configuration are on the fold-in page!



G9 max. 33W, optional LED Retrofit
 G9 max. 33W, LED Retrofit optional

Leuchtmittelempfehlung: LED max. 3W/300lm/2.700K/dimmbar **G** Art Nr. 8-205
 bulb recommendation: LED max. 3W/300Lm/2.700K/dimmable **G** Item No. 8-205

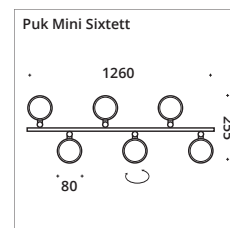
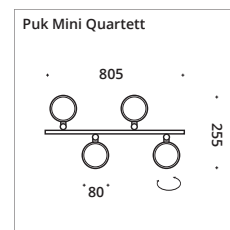

Chrom Teile/
chrome parts
 Gepulverte Teile/
powder-coating

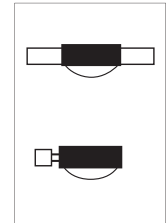





Puk Maxx Quartett & Sixtett ø 120

Pendelleuchte mit drehbaren Köpfen, Hochvolt Halogen oder LED Power. Pendellänge ca. 1.300 mm, Standard-Textilkabel in anthrazit.

Pendant luminaires in high voltage halogen or LED Power, dimmable. Pendant length approx. 1,300 mm. Textile cable in anthracite as standard.

INDOOR



chrome

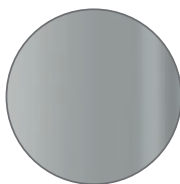

chrome matt

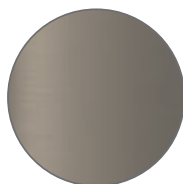

nickel matt

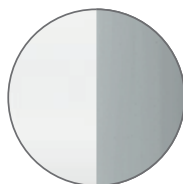

white matt/
chrome

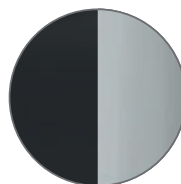

black matt/
chrome

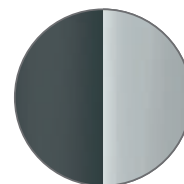

anthracite matt/
chrome

Puk Maxx LED ~2.700k	Puk Maxx G9 Fassung	Pendellänge x L pendular length x l in mm	Gehäuse body
Quartett 8 x 12W, ~7.200lm			
<ul style="list-style-type: none"> 5-37801-4 5-37802-4 5-37803-4 5-37802-4-22 5-37802-4-02 5-37802-4-23 	Quartett 5-37801-4-H 5-37802-4-H 5-37803-4-H 5-37802-4-H-22 5-37802-4-H-02 5-37802-4-H-23	2.000 x 805 2.000 x 805 2.000 x 805 2.000 x 805 2.000 x 805 2.000 x 805	chrome matt chrome nickel matt white matt/chr. black matt/chr. anthracite matt/chr.
Sixtett 12 x 12W, ~10.800lm			
<ul style="list-style-type: none"> 5-371201-6 5-371202-6 5-371203-6 5-371202-6-22 5-371202-6-02 5-371202-6-23 	Sixtett 5-371201-6-H 5-371202-6-H 5-371203-6-H 5-371202-6-H-22 5-371202-6-H-02 5-371202-6-H-23	2.000 x 1.260 2.000 x 1.260 2.000 x 1.260 2.000 x 1.260 2.000 x 1.260 2.000 x 1.260	chrome matt chrome nickel matt white matt/chr. black matt/chr. anthracite matt/chr.



Optional Kabelvarianten.
Optional cable.



▶ Ohne Zubehör. Bestell-Artikelnummern für Linse, Glas, Farbfilter und die Konfigurationsempfehlung auf der Einklappseite!



▶ Without accessories: Order item-no. for lens, glass, color filter and the recommended Configuration are on the fold-in page!

G9 max. 33W, optional LED Retrofit

G9 max. 33W, LED Retrofit optional

Leuchtmittelempfehlung: LED max. 3W/300lm/2.700K/dimmbar Art Nr. 8-205
bulb recommendation: LED max. 3W/300Lm/2.700K/dimmable Item No. 8-205

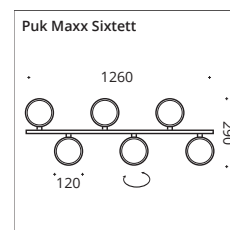
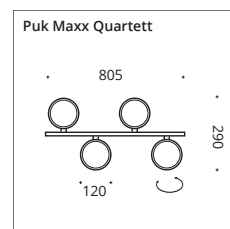

Chrom Teile/
chrome parts
 Gepulverte Teile/
powder-coating

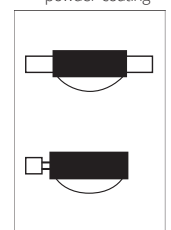





Puk Mini Choice Long One ø 80

Der Lichtbalken ist bestückt mit Puk Mini Long One Pendelleuchten in Hochvolt Halogen oder LED. Zur Direktmontage an der Decke. Pendellänge ca. 1.300 mm, Standard-Textilkabel in anthrazit.

The light bar is equipped with Puk Mini Long One pendant luminaires in high voltage halogen or LED. For direct mounting on the ceiling. Pendant length approx. 1,300 mm. Textile cable in anthracite as standard.

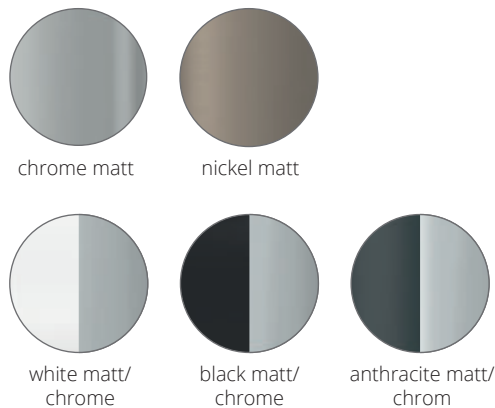

INDOOR

G9 Fassung

450 mm L 2 Köpfe/heads	850 mm L 3 Köpfe/heads	1.050 mm L 4 Köpfe/heads	1.250 mm L 4 Köpfe/heads	Gehäuse body
8-6054021-H	8-6058031-H	8-60510041-H	8-60512041-H	chrome matt
8-6054022-H	8-6058032-H	8-60510042-H	8-60512042-H	chrome
8-6054023-H	8-6058033-H	8-60510043-H	8-60512043-H	nickel matt
8-6054022-H-22	8-6058032-H-22	8-60510042-H-22	8-60512042-H-22	white matt/chr.
8-6054022-H-02	8-6058032-H-02	8-60510042-H-02	8-60512042-H-02	black matt/chr.
8-6054022-H-23	8-6058032-H-23	8-60510042-H-23	8-60512042-H-23	anthracite matt/chr.

Farbig gepulverter Lichtbalken auf Anfrage. Color powdered metal rail on request.

- ▶ Ohne Zubehör. Bestell-Artikelnummern für Linse, Glas, Farbfilter und die Konfigurationsempfehlung auf der Einklappseite!
- ▶ Without accessories: Order item-no. for lens, glass, color filter and the recommended Configuration are on the fold-in page!



- 💡 G9 max. 33W, optional LED Retrofit
- 💡 G9 max. 33W, LED Retrofit optional

- 💡 Leuchtmittlempfehlung: LED max. 3W/300lm/2.700K/dimmbar **G** Art Nr. 8-205
- 💡 bulb recommendation: LED max. 3W/300Lm/2.700K/dimmable **G** Item No. 8-205

LED

450 mm L 2 Köpfe/heads G 2 x 8W, ~1.200lm, ~2.700k	850 mm L 3 Köpfe/heads G 3 x 8W, ~1.800lm, ~2.700k	1.050 mm L 4 Köpfe/heads G 4 x 8W, ~2.400lm, ~2.700k	1.250 mm L 4 Köpfe/heads G 4 x 8W, ~2.400lm, ~2.700k	Gehäuse body
8-6054021	8-6058031	8-60510041	8-60512041	chrome matt
8-6054022	8-6058032	8-60510042	8-60512042	chrome
8-6054023	8-6058033	8-60510043	8-60512043	nickel matt
8-6054022-22	8-6058032-22	8-60510042-22	8-60512042-22	white matt/chr.
8-6054022-02	8-6058032-02	8-60510042-02	8-60512042-02	black matt/chr.
8-6054022-23	8-6058032-23	8-60510042-23	8-60512042-23	anthracite matt/chr.

Farbig gepulverter Lichtbalken auf Anfrage. Color powdered metal rail on request.

- ▶ Ohne Zubehör. Bestell-Artikelnummern für Linse, Glas, Farbfilter und die Konfigurationsempfehlung auf der Einklappseite!
- ▶ Without accessories: Order item-no. for lens, glass, color filter and the recommended Configuration are on the fold-in page!



Sonderanfertigung:

Art-Nr. 8-600 Kürzung auf Maß
Item No. 8-600 Customized lengths

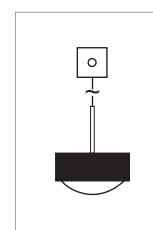
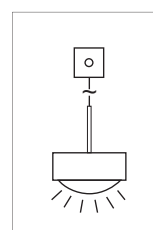
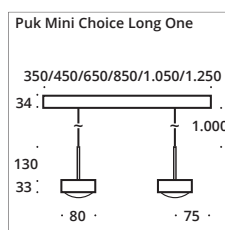

☐ Chrom Teile/
chrome parts
■ Gepulverte Teile/
powder-coating



Puk Maxx Choice Long One



Puk Maxx Choice Long One ø 120

Der Lichtbalken ist bestückt mit Puk Maxx Long One Pendelleuchten in Hochvolt Halogen oder LED. Zur Direktmontage an der Decke. Pendellänge ca. 1.300 mm, Standard-Textilkabel in anthrazit.

The light bar is equipped with Puk Maxx Long One pendant luminaires in high voltage halogen or LED. For direct mounting on the ceiling. Pendant length approx. 1,300 mm. Textile cable in anthracite as standard.

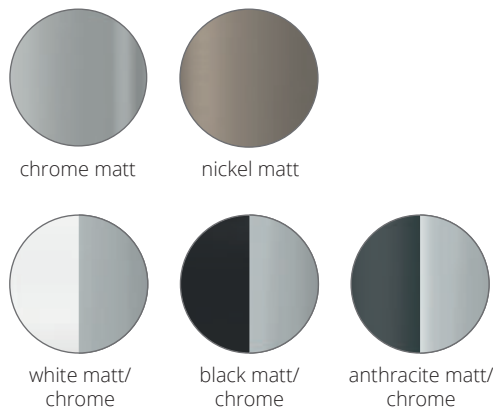

INDOOR

G9 Fassung

450 mm L 2 Köpfe/heads	850 mm L 3 Köpfe/heads	1.050 mm L 4 Köpfe/heads	1.250 mm L 4 Köpfe/heads	Gehäuse body
8-6854021-H	8-6858031-H	8-68510041-H	8-68512041-H	chrome matt
8-6854022-H	8-6858032-H	8-68510042-H	8-68512042-H	chrome
8-6854023-H	8-6858033-H	8-68510043-H	8-68512043-H	nickel matt
8-6854022-H-22	8-6858032-H-22	8-68510042-H-22	8-68512042-H-22	white matt/chr.
8-6854022-H-02	8-6858032-H-02	8-68510042-H-02	8-68512042-H-02	black matt/chr.
8-6854022-H-23	8-6858032-H-23	8-68510042-H-23	8-68512042-H-23	anthracite matt/chr.

Farbig gepulverter Lichtbalken auf Anfrage. Color powdered metal rail on request.

- ▶ Ohne Zubehör. Bestell-Artikelnummern für Linse, Glas, Farbfilter und die Konfigurationsempfehlung auf der Einklappseite!
- ▶ Without accessories: Order item-no. for lens, glass, color filter and the recommended Configuration are on the fold-in page!

G9 max. 33W, optional LED Retrofit
 G9 max. 33W, LED Retrofit optional

Leuchtmittelempfehlung: LED max. 3W/300lm/2.700K/dimmbar **G** Art Nr. 8-205
 bulb recommendation: LED max. 3W/300lm/2.700K/dimmable **G** Item No. 8-205

LED

450 mm L 2 Köpfe/heads G 2 x 12W, ~1.800lm, ~2.700k	850 mm L 3 Köpfe/heads G 3 x 12W, ~2.700lm, ~2.700k	1.050 mm L 4 Köpfe/heads G 4 x 12W, ~3.600lm, ~2.700k	1.250 mm L 4 Köpfe/heads G 4 x 12W, ~3.600lm, ~2.700k	Gehäuse body
8-6854021	8-6858031	8-68510041	8-68512041	chrome matt
8-6854022	8-6858032	8-68510042	8-68512042	chrome
8-6854023	8-6858033	8-68510043	8-68512043	nickel matt
8-6854022-22	8-6858032-22	8-68510042-22	8-68512042-22	white matt/chr.
8-6854022-02	8-6858032-02	8-68510042-02	8-68512042-02	black matt/chr.
8-6854022-23	8-6858032-23	8-68510042-23	8-68512042-23	anthracite matt/chr.

Farbig gepulverter Lichtbalken auf Anfrage. Color powdered metal rail on request.

- ▶ Ohne Zubehör. Bestell-Artikelnummern für Linse, Glas, Farbfilter und die Konfigurationsempfehlung auf der Einklappseite!
- ▶ Without accessories: Order item-no. for lens, glass, color filter and the recommended Configuration are on the fold-in page!

Sonderanfertigung:

Art-Nr. 8-600 Kürzung auf Maß
 Item No. 8-600 Customized lengths

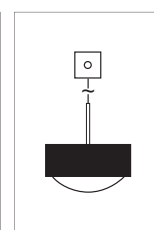
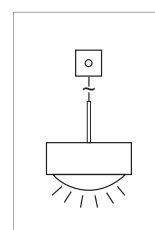
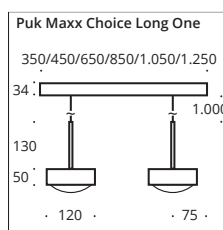

□ Chrom Teile/
chrome parts
 ■ Gepulverte Teile/
powder-coating





Puk Mini Choice Drop ø 80

Der Lichtbalken ist bestückt mit Puk Mini Drop Pendelleuchten in Hochvolt Halogen oder LED. Zur Direktmontage an der Decke. Pendellänge ca. 1.300 mm, Standard-Textilkabel in anthrazit.

The light bar is equipped with Puk Mini Drop pendant luminaires in high voltage halogen or LED. For direct mounting on the ceiling. Pendant length approx. 1,300 mm. Textile cable in anthracite as standard.

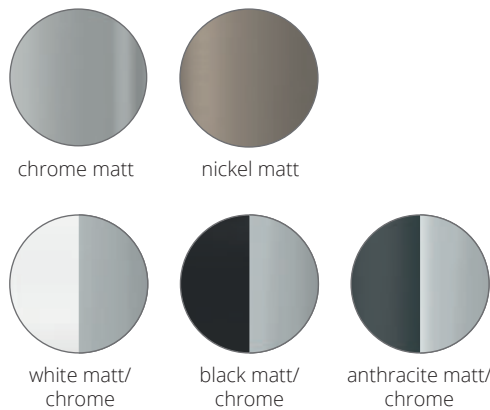

INDOOR

G9 Fassung

450 mm L 2 Köpfe/heads	850 mm L 3 Köpfe/heads	1.050 mm L 4 Köpfe/heads	1.250 mm L 4 Köpfe/heads	Gehäuse body
8-6074021-H	8-6078031-H	8-60710041-H	8-60712041-H	chrome matt
8-6074022-H	8-6078032-H	8-60710042-H	8-60712042-H	chrome
8-6074023-H	8-6078033-H	8-60710043-H	8-60712043-H	nickel matt
8-6074022-H-22	8-6078032-H-22	8-60710042-H-22	8-60712042-H-22	white matt/chr.
8-6074022-H-02	8-6078032-H-02	8-60710042-H-02	8-60712042-H-02	black matt/chr.
8-6074022-H-23	8-6078032-H-23	8-60710042-H-23	8-60712042-H-23	anthracite matt/chr.

Farbig gepulverter Lichtbalken auf Anfrage. Color powdered metal rail on request.

- ▶ Ohne Zubehör. Bestell-Artikelnummern für Linse, Glas, Farbfilter und die Konfigurationsempfehlung auf der Einklappseite!
- ▶ Without accessories: Order item-no. for lens, glass, color filter and the recommended Configuration are on the fold-in page!

G9 max. 33W, optional LED Retrofit
 G9 max. 33W, LED Retrofit optional

Leuchtmittelempfehlung: LED max. 3W/300lm/2.700K/dimmbar **G** Art Nr. 8-205
 bulb recommendation: LED max. 3W/300lm/2.700K/dimmable **G** Item No. 8-205

LED

450 mm L 2 Köpfe/heads G	850 mm L 3 Köpfe/heads G	1.050 mm L 4 Köpfe/heads G	1.250 mm L 4 Köpfe/heads G	Gehäuse body
4 x 8W, ~2.400lm, ~2.700k	6 x 8W, ~3.600lm, ~2.700k	8 x 8W, ~4.800lm, ~2.700k	8 x 8W, ~4.800lm, ~2.700k	
8-6074021	8-6078031	8-60710041	8-60712041	chrome matt
8-6074022	8-6078032	8-60710042	8-60712042	chrome
8-6074023	8-6078033	8-60710043	8-60712043	nickel matt
8-6074022-22	8-6078032-22	8-60710042-22	8-60712042-22	white matt/chr.
8-6074022-02	8-6078032-02	8-60710042-02	8-60712042-02	black matt/chr.
8-6074022-23	8-6078032-23	8-60710042-23	8-60712042-23	anthracite matt/chr.

Farbig gepulverter Lichtbalken auf Anfrage. Color powdered metal rail on request.

- ▶ Ohne Zubehör. Bestell-Artikelnummern für Linse, Glas, Farbfilter und die Konfigurationsempfehlung auf der Einklappseite!
- ▶ Without accessories: Order item-no. for lens, glass, color filter and the recommended Configuration are on the fold-in page!

Sonderanfertigung:

Art-Nr. 8-600 Kürzung auf Maß
 Item No. 8-600 Customized lengths

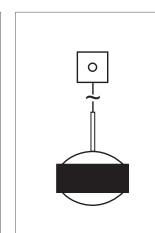
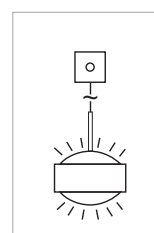
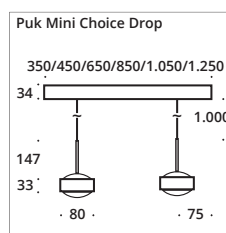

□ Chrom Teile/
chrome parts
■ Gepulverte Teile/
powder-coating





Puk Maxx Choice Drop \varnothing 120

Der Lichtbalken ist bestückt mit Puk Maxx Drop Pendelleuchten in Hochvolt Halogen oder LED. Zur Direktmontage an der Decke. Pendellänge ca. 1.300 mm, Standard-Textilkabel in anthrazit.

The light bar is equipped with Puk Maxx Drop pendant luminaires in high voltage halogen or LED. For direct mounting on the ceiling. Pendant length approx. 1,300 mm. Textile cable in anthracite as standard.

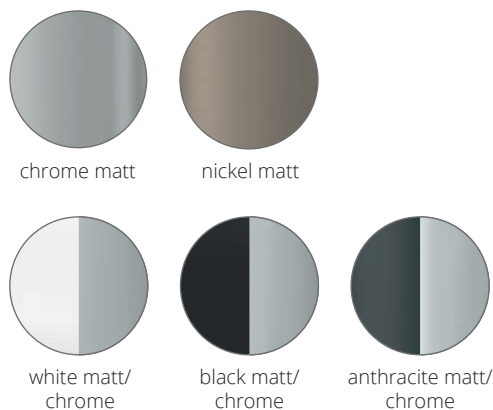

INDOOR

G9 Fassung

450 mm L 2 Köpfe/heads	850 mm L 3 Köpfe/heads	1.050 mm L 4 Köpfe/heads	1.250 mm L 4 Köpfe/heads	Gehäuse body
8-6874021-H	8-6878031-H	8-68710041-H	8-68712041-H	chrome matt
8-6874022-H	8-6878032-H	8-68710042-H	8-68712042-H	chrome
8-6874023-H	8-6878033-H	8-68710043-H	8-68712043-H	nickel matt
8-6874022-H-22	8-6878032-H-22	8-68710042-H-22	8-68712042-H-22	white matt/chr.
8-6874022-H-02	8-6878032-H-02	8-68710042-H-02	8-68712042-H-02	black matt/chr.
8-6874022-H-23	8-6878032-H-23	8-68710042-H-23	8-68712042-H-23	anthracite matt/chr.

Farbig gepulverter Lichtbalken auf Anfrage. Color powdered metal rail on request.

- ▶ Ohne Zubehör. Bestell-Artikelnummern für Linse, Glas, Farbfilter und die Konfigurationsempfehlung auf der Einklappseite!
- ▶ Without accessories: Order item-no. for lens, glass, color filter and the recommended Configuration are on the fold-in page!

G9 max. 33W, optional LED Retrofit
G9 max. 33W, LED Retrofit optional

Leuchtmittelempfehlung: LED max. 3W/300lm/2.700K/dimmbar **G** Art Nr. 8-205
bulb recommendation: LED max. 3W/300lm/2.700K/dimmable **G** Item No. 8-205

LED

450 mm L 2 Köpfe/heads G	850 mm L 3 Köpfe/heads G	1.050 mm L 4 Köpfe/heads G	1.250 mm L 4 Köpfe/heads G	Gehäuse body
4 x 12W, ~3.600lm, ~2.700k	6 x 12W, ~5.400lm, ~2.700k	8 x 12W, ~7.200lm, ~2.700k	8 x 12W, ~7.200lm, ~2.700k	
8-6874021	8-6878031	8-68710041	8-68712041	chrome matt
8-6874022	8-6878032	8-68710042	8-68712042	chrome
8-6874023	8-6878033	8-68710043	8-68712043	nickel matt
8-6874022-22	8-6878032-22	8-68710042-22	8-68712042-22	white matt/chr.
8-6874022-02	8-6878032-02	8-68710042-02	8-68712042-02	black matt/chr.
8-6874022-23	8-6878032-23	8-68710042-23	8-68712042-23	anthracite matt/chr.

Farbig gepulverter Lichtbalken auf Anfrage. Color powdered metal rail on request.

- ▶ Ohne Zubehör. Bestell-Artikelnummern für Linse, Glas, Farbfilter und die Konfigurationsempfehlung auf der Einklappseite!
- ▶ Without accessories: Order item-no. for lens, glass, color filter and the recommended Configuration are on the fold-in page!

Sonderanfertigung:

Art-Nr. 8-600 Kürzung auf Maß
Item No. 8-600 Customized lengths

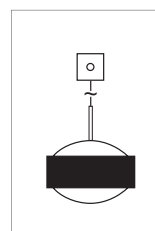
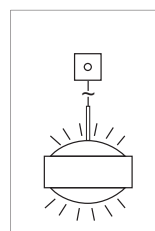
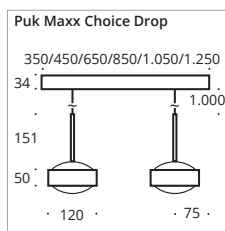

□ Chrom Teile/
chrome parts
■ Gepulverte Teile/
powder-coating





Puk Crown S ø 80/120

Die Puk Serie als exklusive Ringleuchte. Die Bestückung ist variierbar mit den Puk Mini und Puk Maxx Köpfen. In schlichtem eleganten Design mit LED oder Halogen bestückt, wird eine harmonische Raumausleuchtung geschaffen. Die Ringgröße S, mit drei Leuchtenköpfen, sorgt für eine optimale Beleuchtung kleinerer Tische oder Raumecken. Pendellänge ca. 1.300 mm, Standard-Textilkabel in anthrazit.

The Puk series as an exclusive ring luminaire. The fitting is variable with the Puk Mini and Puk Maxx heads. In a simple elegant design, equipped with LED or high-voltage halogen, a harmonious room illumination is created. The ring size S, with three luminaire heads, provides optimal lighting for tables or small room corners. Pendant length approx. 1300 mm, with textile cable in anthracite as standard.

INDOOR

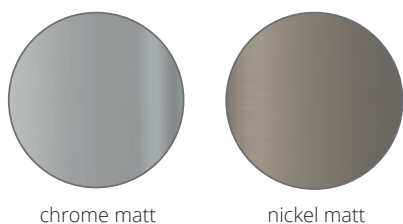

G9 Fassung

Puk Mini Crown G9 Fassung	Puk Maxx Crown G9 Fassung	Gehäuse body
S 400/560	S 400/560	
● 8-050341-H	● 8-350341-H	chrome matt
● 8-050342-H	● 8-350342-H	chrome
● 8-050343-H	● 8-350343-H	nickel matt

▶ Ohne Zubehör. Bestell-Artikelnummern für Linse, Glas, Farbfilter und die Konfigurationsempfehlung auf der Einklappseite!

▶ Without accessories: Order item-no. for lens, glass, color filter and the recommended Configuration are on the fold-in page!

💡 G9 max. 33W, optional LED Retrofit

💡 G9 max. 33W, LED Retrofit optional

💡 LME: LED max. 3W/300lm/2.700K/dimmbar Art Nr. 8-205

💡 bulb recom.: LED max. 3W/300Lm/2.700K/dimmable Item No. 8-205

LED

Puk Mini Crown LED	Puk Maxx Crown LED	Gehäuse body
6 x 8 W ~3.600lm ~2.700k	6 x 12 W ~5.400lm ~2.700k	
S 400/560	S 400/560	
● 8-050341-LED	● 8-350341-LED	chrome matt
● 8-050342-LED	● 8-350342-LED	chrome
● 8-050343-LED	● 8-350343-LED	nickel matt

▶ Ohne Zubehör. Bestell-Artikelnummern für Linse, Glas, Farbfilter und die Konfigurationsempfehlung auf der Einklappseite!

▶ Without accessories: Order item-no. for lens, glass, color filter and the recommended Configuration are on the fold-in page!

Sondergrößen auf Maß siehe Seite 330 – 339.

For special requirements, please look at page 330 – 339.

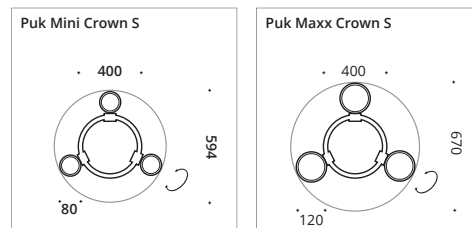

Kabellänge für Abhängung 2.000 mm (kürzbar)
Cable length for suspension 2.000 mm (can be shortened)



CD (s.S 6-7/s.p. 6-7)





Puk Crown M ø 80/120

Die Puk Serie als exklusive Ringleuchte. Die Bestückung ist variierbar mit den Puk Mini und Puk Maxx Köpfen. In schlichtem eleganten Design mit LED oder Halogen bestückt, wird eine harmonische Raumausleuchtung geschaffen. Die Ringgröße M, mit vier Leuchtenköpfen, sorgt für eine optimale Beleuchtung von Esstischen oder partiellen Raumbereichen. Pendellänge ca. 1.300 mm, Standard-Textilkabel in anthrazit.

The Puk series as an exclusive ring luminaire. In a simple elegant design, equipped with LED or high-voltage halogen, a harmonious room illumination is created. The fitting is variable with the Puk Mini and Puk Maxx heads. The ring size M, with 4 luminaire heads, provides optimal lighting for dining tables or partial room areas. Pendant length approx. 1300 mm, with textile cable in anthracite as standard.

INDOOR

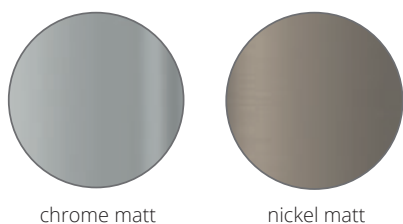

G9 Fassung

Puk Mini Crown G9 Fassung	Puk Maxx Crown G9 Fassung	Gehäuse body
M 700/860	M 700/860	
● 8-050471-H	8-350471-H	chrome matt
● 8-050472-H	8-350472-H	chrome
● 8-050473-H	8-350473-H	nickel matt

▶ Ohne Zubehör. Bestell-Artikelnummern für Linse, Glas, Farbfilter und die Konfigurationsempfehlung auf der Einklappseite!

▶ Without accessories: Order item-no. for lens, glass, color filter and the recommended Configuration are on the fold-in page!

💡 G9 max. 33W, optional LED Retrofit

💡 G9 max. 33W, LED Retrofit optional

💡 LME: LED max. 3W/300lm/2.700K/dimmbar Art Nr. 8-205
bulb recom.: LED max. 3W/300Lm/2.700K/dimmable Item No. 8-205

LED

Puk Mini Crown LED	Puk Maxx Crown LED	Gehäuse body
8 x 8 W ~4.800lm ~2.700k	8 x 12 W ~7.200lm ~2.700k	
M 700/860	M 700/860	
● 8-050471-LED	8-350471-LED	chrome matt
● 8-050472-LED	8-350472-LED	chrome
● 8-050473-LED	8-350473-LED	nickel matt

▶ Ohne Zubehör. Bestell-Artikelnummern für Linse, Glas, Farbfilter und die Konfigurationsempfehlung auf der Einklappseite!

▶ Without accessories: Order item-no. for lens, glass, color filter and the recommended Configuration are on the fold-in page!

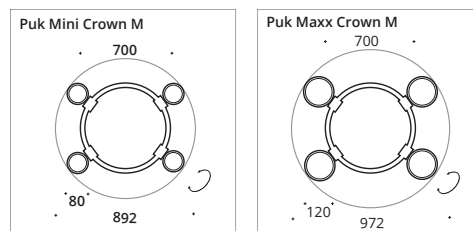

Kabellänge für Abhängung 2.000 mm (kürzbar)
Cable length for suspension 2.000 mm (can be shortened)

Sondergrößen auf Maß siehe Seite 330 – 339.
For special requirements, please look at page 330 – 339.







Puk Crown L ø 80/120

Die Puk Serie als exklusive Ringleuchte. Die Bestückung ist variabel mit den Puk Mini und Puk Maxx Köpfen. In schlichtem eleganten Design mit LED oder Halogen bestückt, wird eine harmonische Raumausleuchtung geschaffen. Die Ringgröße L, mit sechs Leuchtenköpfen, sorgt für eine optimale Beleuchtung großer Tische oder ganzer Räume. Pendellänge ca. 1.300 mm, Standard-Textilkabel in anthrazit.

The Puk series as an exclusive ring luminaire. The fitting is variable with the Puk Mini and Puk Maxx heads. In a simple elegant design, equipped with LED or high-voltage halogen, a harmonious room illumination is created. The ring size L, with 6 luminaire heads, provides optimal lighting for large tables or entire rooms. Pendant length approx. 1300 mm, with textile cable in anthracite as standard.

INDOOR

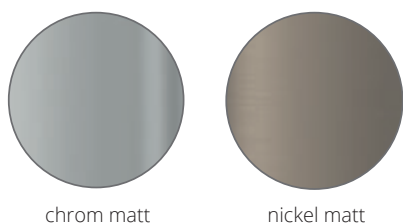

G9 Fassung

Puk Mini Crown G9 Fassung	Puk Maxx Crown G9 Fassung	Gehäuse body
L 1100/1260	L 1100/1260	
● 8-0506111-H	8-3506111-H	chrome matt
● 8-0506112-H	8-3506112-H	chrome
● 8-0506113-H	8-3506113-H	nickel matt

- ▶ Ohne Zubehör. Bestell-Artikelnummern für Linse, Glas, Farbfilter und die Konfigurationsempfehlung auf der Einklappseite!
- ▶ Without accessories: Order item-no. for lens, glass, color filter and the recommended Configuration are on the fold-in page!

- 💡 G9 max. 33W, optional LED Retrofit
- 💡 G9 max. 33W, LED Retrofit optional
- 💡 LME: LED max. 3W/300lm/2.700K/dimmbar **G** Art Nr. 8-205
- 💡 bulb recom.: LED max. 3W/300lm/2.700K/dimmable **G** Item No. 8-205

LED

Puk Mini Crown LED G	Puk Maxx Crown LED G	Gehäuse body
12 x 8 W ~7.200lm ~2.700k	12 x 12 W ~10.800lm ~2.700k	
L 1100/1260	L 1100/1260	
● 8-0506111-LED	8-3506111-LED	chrome matt
● 8-0506112-LED	8-3506112-LED	chrome
● 8-0506113-LED	8-3506113-LED	nickel matt

- ▶ Ohne Zubehör. Bestell-Artikelnummern für Linse, Glas, Farbfilter und die Konfigurationsempfehlung auf der Einklappseite!
- ▶ Without accessories: Order item-no. for lens, glass, color filter and the recommended Configuration are on the fold-in page!

Sondergrößen auf Maß siehe Seite 330 – 339.
For special requirements, please look at page 330 – 339.

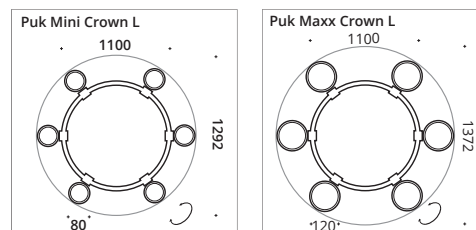

Kabellänge für Abhängung 5.000 mm (kürzbar)
Cable length for suspension 5.000 mm (can be shortened)





Puk Maxx Crown XL



Puk Crown XL ø 80/120

Die Puk Serie als exklusive Ringleuchte. Die Bestückung ist variierbar mit den Puk Mini und Puk Maxx Köpfen. Alle drei Ringe zusammengefügt zur Puk Crown XL mit insgesamt 13 Leuchtenköpfen ist diese Leuchte ideal für die Beleuchtung hoher Räume oder Hallen. Standard-Textilkabel in anthrazit.

The Puk series as an exclusive ring luminaire. The fitting is variable with the Puk Mini and Puk Maxx heads. All three rings combined to form the Puk Crown XL, with a total of 13 luminaire heads, this luminaire is ideal for lighting high rooms or entrance halls. With textile cable in anthracite as standard.

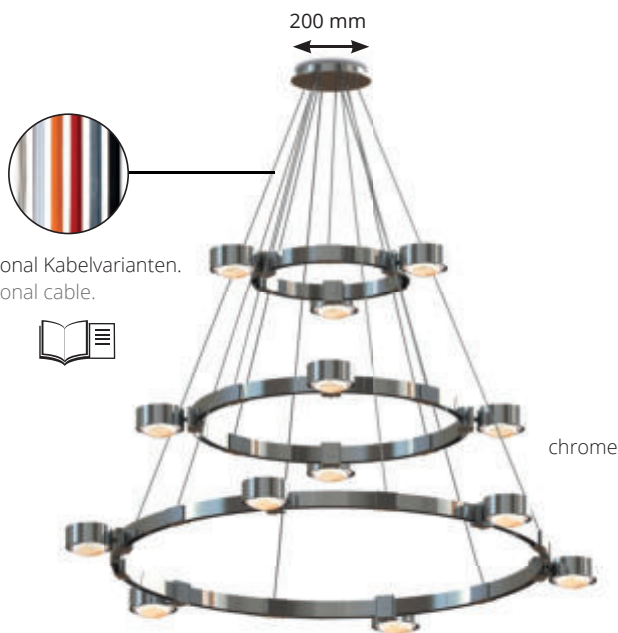
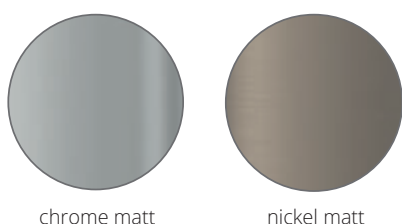

G9 Fassung S+M+L

Puk Mini Crown G9 Fassung	Puk Maxx Crown G9 Fassung	Gehäuse body
XL 1100/1260	XL 1100/1260	
● 8-0513111-H	● 8-3513111-H	chrome matt
● 8-0513112-H	● 8-3513112-H	chrome
● 8-0513113-H	● 8-3513113-H	nickel matt

- ▶ Ohne Zubehör. Bestell-Artikelnummern für Linse, Glas, Farbfilter und die Konfigurationsempfehlung auf der Einklappseite!
- ▶ Without accessories: Order item-no. for lens, glass, color filter and the recommended Configuration are on the fold-in page!



● G9 max. 33W, optional LED Retrofit
 ⚡ G9 max. 33W, LED Retrofit optional

● Leuchtmittelempfehlung: LED max. 3W/300lm/2.700K/dimmbar **G** Art Nr. 8-205
 ⚡ bulb recommendation: LED max. 3W/300Lm/2.700K/dimmable **G** Item No. 8-205

LED S+M+L

Puk Mini Crown LED G	Puk Maxx Crown LED G	Gehäuse body
26 x 8 W ~15.600lm ~2.700k	26 x 12 W ~23.400lm ~2.700k	
XL 1100/1260	XL 1100/1260	
● 8-0513111-LED	● 8-3513111-LED	chrome matt
● 8-0513112-LED	● 8-3513112-LED	chrome
● 8-0513113-LED	● 8-3513113-LED	nickel matt

- ▶ Ohne Zubehör. Bestell-Artikelnummern für Linse, Glas, Farbfilter und die Konfigurationsempfehlung auf der Einklappseite!
- ▶ Without accessories: Order item-no. for lens, glass, color filter and the recommended Configuration are on the fold-in page!

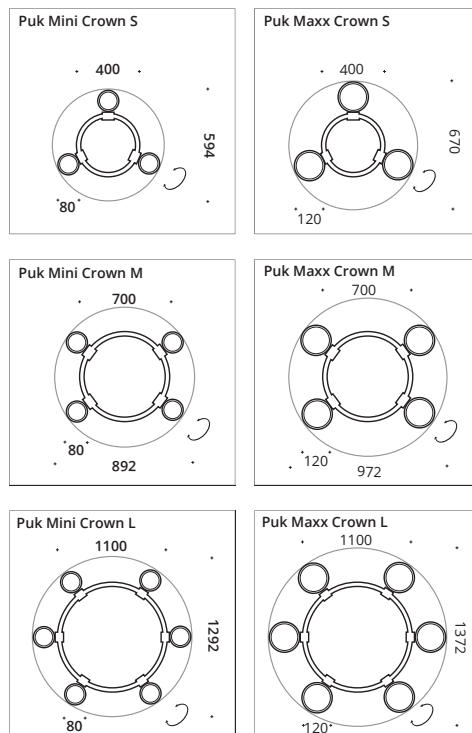

Kabellänge für Abhängung 5.000 mm (kürzbar)
 Cable length for suspension 5.000 mm (can be shortened)

Sondergrößen auf Maß siehe Seite 330 – 339.

For special requirements, please look at page 330 – 339.







Puk Line S ø 80/120

Puk Pendelleuchte mit Seilabhängung und parallelen Leuchtenköpfen. Die Schienen werden mit den Puk Mini oder Puk Maxx Größen bestückt. Hierbei sind beide Varianten mit LED und Halogen möglich. Die Größe S bietet Licht für kleine Tische oder partiell im Raum. Pendellänge ca. 1.300 mm, Standard-Textilkabel in anthrazit.

Pendant luminaire with wire suspension and parallel heads. The tracks are equipped with Puk Mini or Puk Maxx luminaire heads. Both versions are available with LED or high-voltage halogen. Size S provides light for small tables and partial room areas. Pendant length approx. 1300 mm, with textile cable in anthracite as standard.

INDOOR

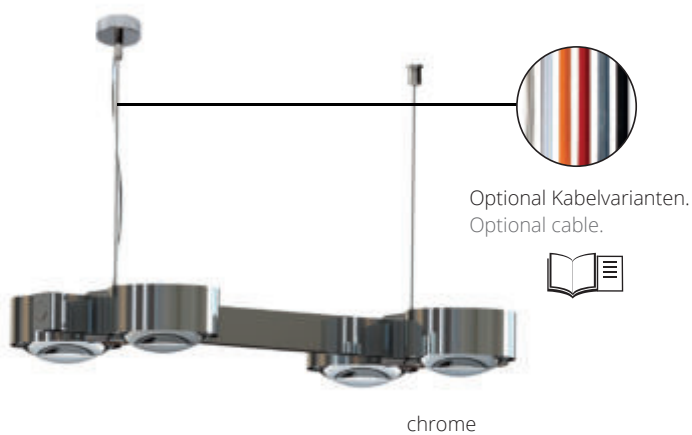
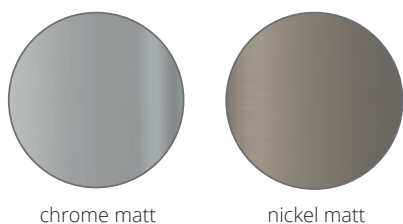

G9 Fassung

Puk Mini Line G9 Fassung	Puk Maxx Line G9 Fassung	Gehäuse body
S 800	S 800	
8-020461-H	8-320461-H	chrome matt
8-020462-H	8-320462-H	chrome
8-020463-H	8-320463-H	nickel matt

- ▶ Ohne Zubehör. Bestell-Artikelnummern für Linse, Glas, Farbfilter und die Konfigurationsempfehlung auf der Einklappseite!
- ▶ Without accessories: Order item-no. for lens, glass, color filter and the recommended Configuration are on the fold-in page!



G9 max. 33W, optional LED Retrofit
 G9 max. 33W, LED Retrofit optional

Leuchtmittelempfehlung: LED max. 3W/300lm/2.700K/dimmbar **G** Art Nr. 8-205
 bulb recommendation: LED max. 3W/300Lm/2.700K/dimmable **G** Item No. 8-205

LED

Puk Mini Line LED G	Puk Maxx Line LED G	Gehäuse body
8 x 8 W ~4.800lm ~2.700k	8 x 12 W ~7.200lm ~2.700k	
S 800	S 800	
8-020461-LED	8-320461-LED	chrome matt
8-020462-LED	8-320462-LED	chrome
8-020463-LED	8-320463-LED	nickel matt

- ▶ Ohne Zubehör. Bestell-Artikelnummern für Linse, Glas, Farbfilter und die Konfigurationsempfehlung auf der Einklappseite!
- ▶ Without accessories: Order item-no. for lens, glass, color filter and the recommended Configuration are on the fold-in page!

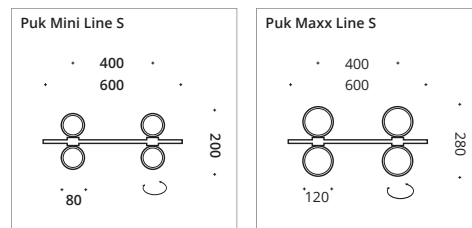

Kabellänge für Abhängung 2.000 mm (kürzbar)
 Cable length for suspension 2.000 mm (can be shortened)

Sondergrößen auf Maß siehe Seite 310 – 319.
 For special requirements, please look at page 310 – 319.







Puk Line M \varnothing 80/120

Puk Pendelleuchte mit Seilabhängung und parallelen Leuchtenköpfen. Die Schienen werden mit den Puk Mini oder Puk Maxx Größen bestückt. Hierbei sind beide Varianten mit LED und Halogen möglich. Die Größe M bietet Licht für Esstische oder Bereiche im Raum. Pendellänge ca. 1.300 mm, Standard-Textilkabel in anthrazit.

Pendant luminaire with wire suspension and parallel heads. The tracks are equipped with Puk Mini or Puk Maxx luminaire heads. Both versions are available with LED or high-voltage halogen. Size M provides light for dining tables or areas in the room that need to be partially illuminated. Pendant length approx. 1300 mm, with textile cable in anthracite as standard.

INDOOR

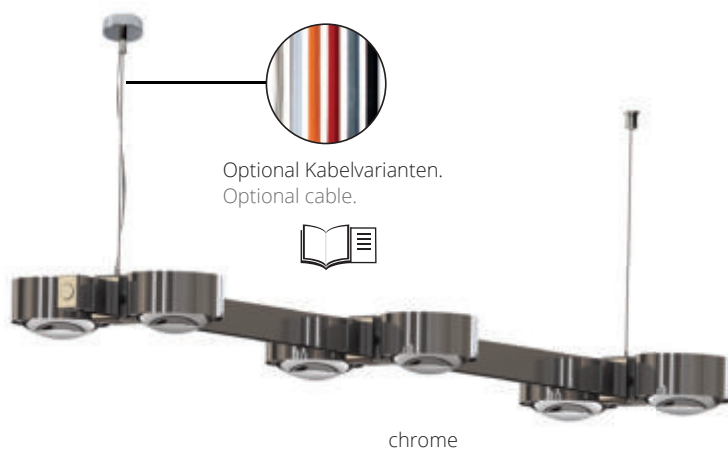
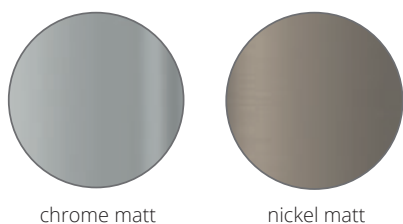

chrome

G9 Fassung

Puk Mini Line G9 Fassung	Puk Maxx Line G9 Fassung	Gehäuse body
M 1200	M 1200	
● 8-0206121-H	8-3206121-H	chrome matt
● 8-0206122-H	8-3206122-H	chrome
● 8-0206123-H	8-3206123-H	nickel matt

▶ Ohne Zubehör. Bestell-Artikelnummern für Linse, Glas, Farbfilter und die Konfigurationsempfehlung auf der Einklappseite!

▶ Without accessories: Order item-no. for lens, glass, color filter and the recommended Configuration are on the fold-in page!

💡 G9 max. 33W, optional LED Retrofit

💡 G9 max. 33W, LED Retrofit optional

💡 Leuchtmittlempfehlung: LED max. 3W/300lm/2.700K/dimmbar **G** Art Nr. 8-205

💡 bulb recommendation: LED max. 3W/300Lm/2.700K/dimmable **G** Item No. 8-205

LED

Puk Mini Line LED G	Puk Maxx Line LED G	Gehäuse body
12 x 8 W ~7.200lm ~2.700k	12 x 12 W ~10.800lm ~2.700k	
M 1200	M 1200	
● 8-0206121-LED	8-3206121-LED	chrome matt
● 8-0206122-LED	8-3206122-LED	chrome
● 8-0206123-LED	8-3206123-LED	nickel matt

▶ Ohne Zubehör. Bestell-Artikelnummern für Linse, Glas, Farbfilter und die Konfigurationsempfehlung auf der Einklappseite!

▶ Without accessories: Order item-no. for lens, glass, color filter and the recommended Configuration are on the fold-in page!

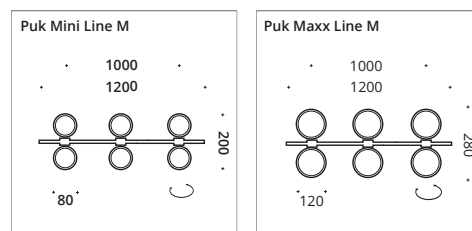

Kabellänge für Abhängung 2.000 mm (kürzbar)
Cable length for suspension 2.000 mm (can be shortened)

Sondergrößen auf Maß siehe Seite 310 – 319.
For special requirements, please look at page 310 – 319.







Puk Line L \varnothing 80/120

Puk Pendelleuchte mit Seilabhängung und parallelen Leuchtenköpfen. Die Schienen werden mit den Puk Mini oder Puk Maxx Größen bestückt. Hierbei sind beide Varianten mit LED und Halogen möglich. Die Größe L bietet Licht für große Tische oder ganze Räume. Pendellänge ca. 1.300 mm, Standard-Textilkabel in anthrazit.

Pendant luminaire with wire suspension and parallel heads. The tracks are equipped with Puk Mini or Puk Maxx luminaire heads. Both versions are available with LED or high-voltage halogen. Size L provides light for large tables or entire rooms. . Pendant length approx. 1300 mm, with textile cable in anthracite as standard.

INDOOR

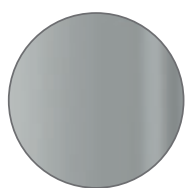

chrome matt



nickel matt

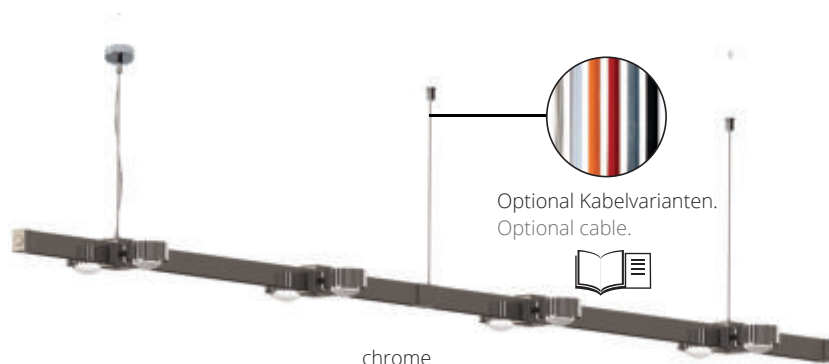

chrome



Optional Kabelvarianten.
Optional cable.



G9 Fassung

Puk Mini Line G9 Fassung	Puk Maxx Line G9 Fassung	Gehäuse body
L 2400	L 2400	
● 8-0208241-H	8-3208241-H	chrome matt
● 8-0208242-H	8-3208242-H	chrome
● 8-0208243-H	8-3208243-H	nickel matt

▶ Ohne Zubehör. Bestell-Artikelnummern für Linse, Glas, Farbfilter und die Konfigurationsempfehlung auf der Einklappseite!
▶ Without accessories: Order item-no. for lens, glass, color filter and the recommended Configuration are on the fold-in page!

● G9 max. 33W, optional LED Retrofit
● G9 max. 33W, LED Retrofit optional

● Leuchtmittelempfehlung: LED max. 3W/300lm/2.700K/dimmbar **G** Art Nr. 8-205
● bulb recommendation: LED max. 3W/300Lm/2.700K/dimmable **G** Item No. 8-205



LED

Puk Mini Line LED G	Puk Maxx Line LED G	Gehäuse body
16 x 8 W ~9.600lm ~2.700k	16 x 12 W ~14.400lm ~2.700k	
L 2400	L 2400	
● 8-0208241-LED	8-3208241-LED	chrome matt
● 8-0208242-LED	8-3208242-LED	chrome
● 8-0208243-LED	8-3208243-LED	nickel matt

▶ Ohne Zubehör. Bestell-Artikelnummern für Linse, Glas, Farbfilter und die Konfigurationsempfehlung auf der Einklappseite!
▶ Without accessories: Order item-no. for lens, glass, color filter and the recommended Configuration are on the fold-in page!

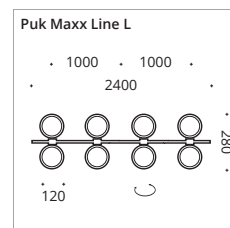
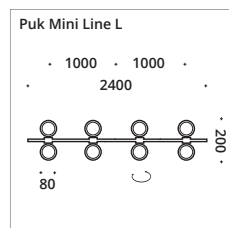

Kabellänge für Abhängung 2.000 mm (kürzbar)
Cable length for suspension 2.000 mm (can be shortened)

Sondergrößen auf Maß siehe Seite 310 – 319.
For special requirements, please look at page 310 – 319.







Sun Swing ø 90/130/210

Der Leuchtenkopf der LED Pendelleuchte Sun Swing Ceiling lässt sich in alle Richtungen über ein Kugelgelenk schwenken. Sie ist in den Durchmessern 90/130/210 mm als Up- oder Downlight erhältlich. Ob direkt oder indirekt, lässt sich das Licht dorthin lenken, wo es benötigt wird. Pendellänge ca. 1.300 mm, Standard-Textilkabel in anthrazit.

The luminaire head of the Sun Ceiling LED luminaires can be swivelled in all directions via a ball joint. It is available in the diameters 90/130/210 mm as uplight or downlight. Whether direct or indirect, the light can be directed to where it is needed. Pendant length approx. 1300 mm, with textile cable in anthracite as standard.

INDOOR

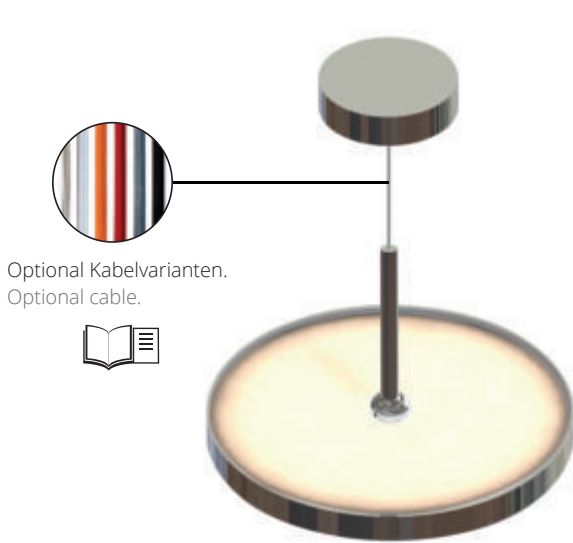

Optional Kabelvarianten.
Optional cable.

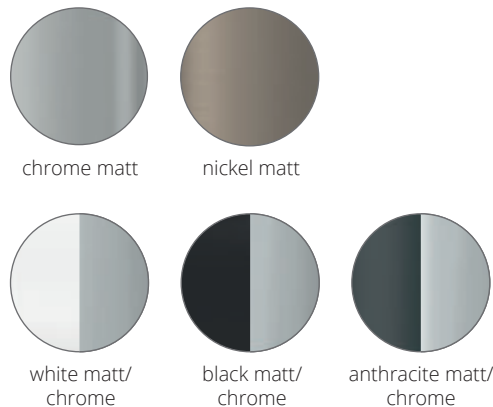

□ Chrom Teile/
chrome parts
■ Gepulverte Teile/
powder-coating

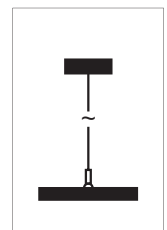

Sun Swing – Up Light

Up Light LED	Up Light LED	Up Light LED	Gehäuse body
Kopf/head: ø 90 mm Baldachin: ø 65 mm G 8 Watt, ~2.700k, ~920 lm	Kopf/head: ø 130 mm Baldachin: ø 65 mm G 12 Watt, ~2.700k, ~1.300 lm	Kopf/head: ø 210 mm Baldachin: ø 80 mm G 16 Watt, ~2.700k, ~1.600 lm	
● 7-3279011 ● 7-3279012 ● 7-3279013 ● 7-3279012-22 ● 7-3279012-02 ● 7-3279012-23	● 7-32713011 ● 7-32713012 ● 7-32713013 ● 7-32713012-22 ● 7-32713012-02 ● 7-32713012-23	● 7-32721011 ● 7-32721012 ● 7-32721013 ● 7-32721012-22 ● 7-32721012-02 ● 7-32721012-23	chrome matt chrome nickel matt white matt/chrome black matt/chrome anthracite matt/chr.

Sun Swing – Down Light

Down Light LED	Down Light LED	Down Light LED	Gehäuse body
Kopf/head: ø 90 mm Baldachin: ø 65 mm G 8 Watt, ~2.700k, ~920 lm	Kopf/head: ø 130 mm Baldachin: ø 65 mm G 12 Watt, ~2.700k, ~1.300 lm	Kopf/head: ø 210 mm Baldachin: ø 80 mm G 16 Watt, ~2.700k, ~1.600 lm	
● 7-3289011 ● 7-3289012 ● 7-3289013 ● 7-3289012-22 ● 7-3289012-02 ● 7-3289012-23	● 7-32813011 ● 7-32813012 ● 7-32813013 ● 7-32813012-22 ● 7-32813012-02 ● 7-32813012-23	● 7-32821011 ● 7-32821012 ● 7-32821013 ● 7-32821012-22 ● 7-32821012-02 ● 7-32821012-23	chrome matt chrome nickel matt white matt/chrome black matt/chrome anthracite matt/chr.

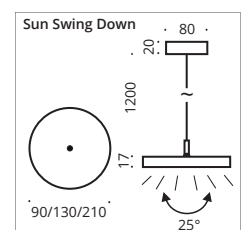
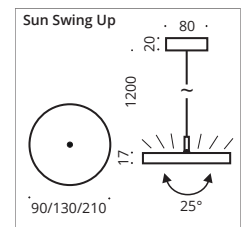
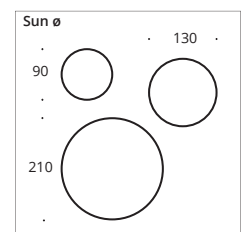





Sun Swing Choice ø 90/130/210

Lichtbalken für Direktmontage an der Decke. Bestückt mit LED Sun Leuchten, Kopfdurchmesser 90, 130 oder 210 mm. Pendellänge ca. 1.300 mm, Standard-Textilkabel in anthrazit.

Light bar for direct mounting on the ceiling. Equipped with LED Sun luminaires, head diameter ø 90, 130 or 210 mm. Pendant length approx. 1300 mm, with textile cable in anthracite as standard.

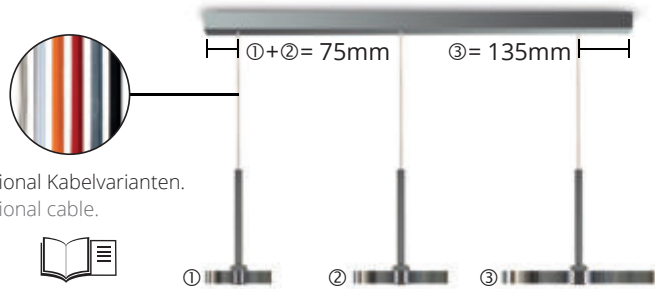
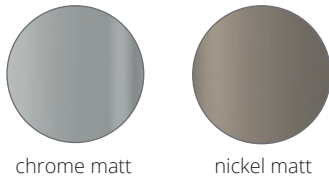

INDOOR

Sun ø 90 mm LED downlight

450 mm L 2 Köpfe/heads G 16W ~1.840lm ~2.700k	850 mm L 3 Köpfe/heads G 24W ~2.760lm ~2.700k	1.050 mm L 4 Köpfe/heads G 32W ~3.680lm ~2.700k	1.250 mm L 4 Köpfe/heads G 32W ~3.680lm ~2.700k	Gehäuse body
8-71904021	8-71908031	8-719010041	8-719012041	chrome matt
8-71904022	8-71908032	8-719010042	8-719012042	chrome
8-71904023	8-71908033	8-719010043	8-719012043	nickel matt
8-71904022-22	8-71908032-22	8-719010042-22	8-719012042-22	white matt/chr.
8-71904022-02	8-71908032-02	8-719010042-02	8-719012042-02	black matt/chr.
8-71904022-23	8-71908032-23	8-719010042-23	8-719012042-23	anthracite matt/chr.

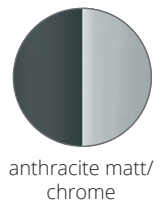
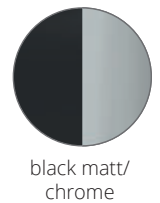
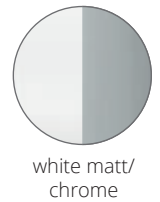

Farbig gepulverter Lichtbalken auf Anfrage. Color powdered metal rail on request.

Sun ø 130 mm LED downlight

450 mm L 2 Köpfe/heads G 24W ~2.600lm ~2.700k	650 mm L 3 Köpfe/heads G 36W ~3.900lm ~2.700k	1.050 mm L 4 Köpfe/heads G 48W ~5.200lm ~2.700k	1.250 mm L 4 Köpfe/heads G 48W ~5.200lm ~2.700k	Gehäuse body
8-711304021	8-711306031	8-7113010041	8-7113012041	chrome matt
8-711304022	8-711306032	8-7113010042	8-7113012042	chrome
8-711304023	8-711306033	8-7113010043	8-7113012043	nickel matt
8-711304022-22	8-711306032-22	8-7113010042-22	8-7113012042-22	white matt/chr.
8-711304022-02	8-711306032-02	8-7113010042-02	8-7113012042-02	black matt/chr.
8-711304022-23	8-711306032-23	8-7113010042-23	8-7113012042-23	anthracite matt/chr.

Farbig gepulverter Lichtbalken auf Anfrage. Color powdered metal rail on request.

Sun ø 210 mm LED downlight

850 mm L 2 Köpfe/heads G 32W ~3.200lm ~2.700k	1.050 mm L 3 Köpfe/heads G 48W ~4.800lm ~2.700k	1.250 mm L 3 Köpfe/heads G 48W ~4.800lm ~2.700k	Gehäuse body
8-712108031	8-7121010041	8-7121012041	chrome matt
8-712108032	8-7121010042	8-7121012042	chrome
8-712108033	8-7121010043	8-7121012043	nickel matt
8-712108032-22	8-7121010042-22	8-7121012042-22	white matt/chr.
8-712108032-02	8-7121010042-02	8-7121012042-02	black matt/chr.
8-712108032-23	8-7121010042-23	8-7121012042-23	anthracite matt/chr.

Farbig gepulverter Lichtbalken auf Anfrage. Color powdered metal rail on request.

Sonderanfertigung:

Art-Nr. 8-600 Kürzung auf Maß
Item No. 8-600 Customized lengths

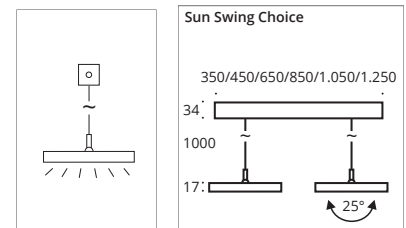
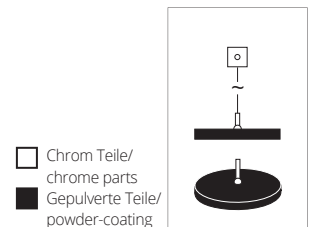





Foxx Swing ø 200/300/400/500

Mit 20 mm ist die Foxx Swing eine sensationell flache LED Pendelleuchte in den Durchmessern 200/300/400/500 mm. Mit Magnethalterungstechnik und der eingesetzten LED Hochvolttechnik heißt es nur noch »plug and light«. Pendellänge ca. 1.300 mm, Standard-Textilkabel in anthrazit.

With only 20 mm, the Foxx Swing is a sensationally slim LED pendant luminaire in the diameters of 200/300/400/500mm. With the high-voltage LED and magnetic mounting technology used, it is just a matter of »plug & light«. Pendant length approx. 1300 mm, with textile cable in anthracite as standard.

INDOOR

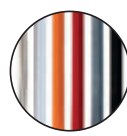
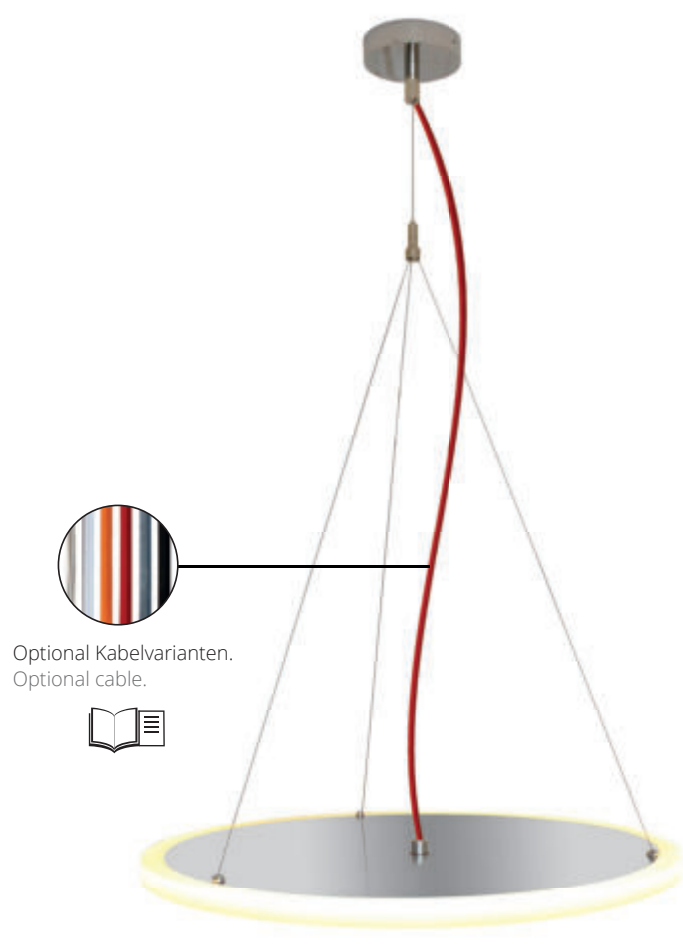

Optional Kabelvarianten.
Optional cable.



Foxx Swing 20/30/40/50 Pendelleuchte/pendant lamp LED

Swing 20 cm ø	Swing 30 cm ø	Swing 40 cm ø	Swing 50 cm ø	Gehäuse body
G	G	G	G	
10 Watt, ~2.700k ~700lm	14 Watt, ~2.700k ~1.260lm	22 Watt, ~2.700k ~1.980lm	33 Watt, ~2.700k ~2.970lm	
7-46620010	7-46630010	7-46640010	7-46650010	alueloxiert/ Acryl

Längere Aufhängung für hohe Decken bis 350 cm: Art-Nr. 7-466350
Extra long cable for high ceilings up to 350 cm: Item No. 7-466350

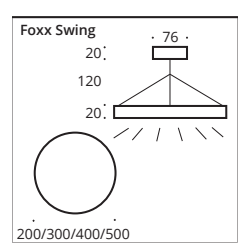

Pela
Quadro

Pela





Pela & Pela Quadro

Runde oder quadratische Pendelleuchte mit anthrazit Standard-Textilkabel und einer Länge von ca. 1.300 mm inklusive Glas und Baldachin. E27 Fassung.

Round or square pendant luminaire including glass and canopy. Pendant length approx. 1300 mm, with textile cable in anthracite as standard. E27 socket.

INDOOR

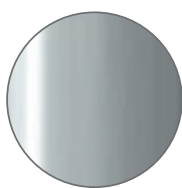

chrome



nickel matt



Richtungsweisend:
Aluminium-Hochleistungsreflektor, einfache Montage durch Einschub in den Glastubus.

Multi directional:
High performance baffle. Easy installation: slides into the tube.

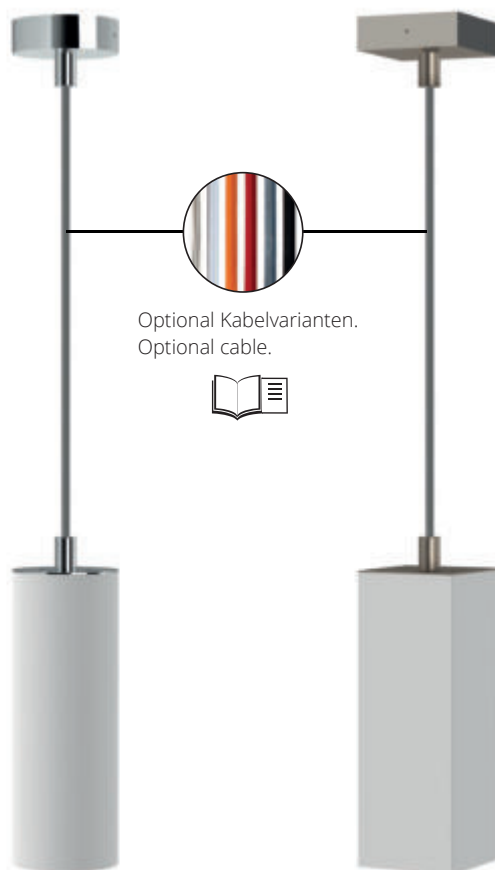

Optional Kabelvarianten.
Optional cable.



E27 Sockel

Art.Nr.
item no.

Oberfläche
surface

● Pela	5-07651	nickel matt
● "Option"	5-07652	chrome
	9-200	Reflektor, baffle
● Pela Quadro	5-08651	nickel matt
●	5-08652	chrome
Kabelverlängerung Cable extension	5-07951	auf Maß customized

E27 max. 42W, optional LED Retrofit

E27 max. 42W, LED Retrofit optional

Leuchtmittelempfehlung: LED max. 9W/800lm/2.700K **G** Art. Nr. 8-309

bulb recommendation: LED max. 9W/800Lm/2.700K **G** Item No. 8-309



Pela: ABC (s.S 6-7/s.p. 6-7)

Quadro: BC (s.S 6-7/s.p. 6-7)

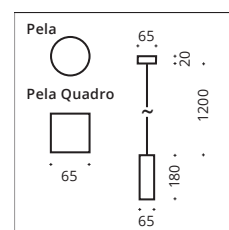





Pela Choice & Pela Quadro Choice

Lichtbalken für Direktmontage an der Decke. Bestückt mit Pela oder Pela Quadro Leuchten. Pendelleuchten aus der Top Light Serie. Pendellänge ca. 1.300 mm, Standard-Textilkabel in anthrazit.

Light bar for direct mounting on the ceiling. Equipped with Pela or Pela Quadro luminaires. Pendant luminaires of the Top Light series. Pendant length approx. 1300 mm, with textile cable in anthracite as standard.

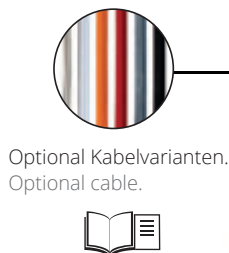
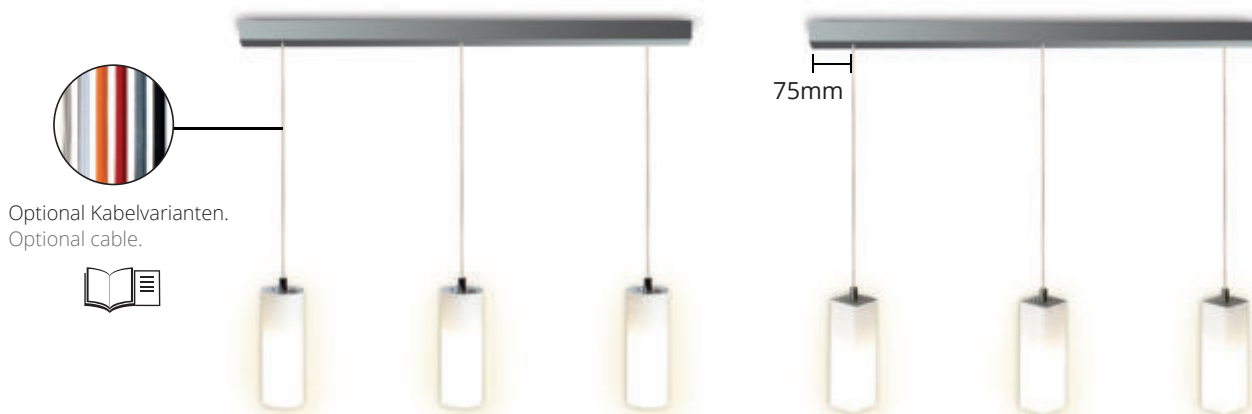

Optional Kabelvarianten.
Optional cable.

INDOOR

Pela

450 mm L	850 mm L	1.050 mm L	1.250 mm L	Gehäuse body
2 Köpfe/heads mit E27 Sockel E27 socket	3 Köpfe/heads mit E27 Sockel E27 socket	4 Köpfe/heads mit E27 Sockel E27 socket	4 Köpfe/heads mit E27 Sockel E27 socket	
8-764021	8-768031	8-7610041	8-7612041	nickel matt
8-764022	8-768032	8-7610042	8-7612042	chrome

Farbig gepulverter Lichtbalken auf Anfrage. Color powdered metal rail on request.

E27 max. 42W, optional LED Retrofit E27 max. 42W, LED Retrofit optional

LMempfehlung: LED max. 9W/800lm/2.700K **G** Art. Nr. 8-309

bulb recommend.: LED max. 9W/800Lm/2.700K **G** Item No. 8-309

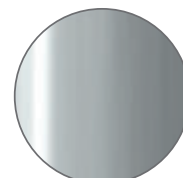

chrome

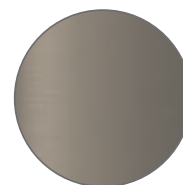

nickel matt

Pela Quadro

450 mm L	850 mm L	1.050 mm L	1.250 mm L	Gehäuse body
2 Köpfe/heads mit E27 Sockel E27 socket	3 Köpfe/heads mit E27 Sockel E27 socket	4 Köpfe/heads mit E27 Sockel E27 socket	4 Köpfe/heads mit E27 Sockel E27 socket	
8-774021	8-778031	8-7710041	8-7712041	nickel matt
8-774022	8-778032	8-7710042	8-7712042	chrome

Farbig gepulverter Lichtbalken auf Anfrage. Color powdered metal rail on request.

E27 max. 42W, optional LED Retrofit E27 max. 42W, LED Retrofit optional

LMempfehlung: LED max. 9W/800lm/2.700K **G** Art. Nr. 8-309

bulb recommend.: LED max. 9W/800Lm/2.700K **G** Item No. 8-309

Sonderanfertigung:

Art-Nr. 8-600 Kürzung auf Maß

Item No. 8-600 Customized lengths



C (S.S 6-7/s.p. 6-7)

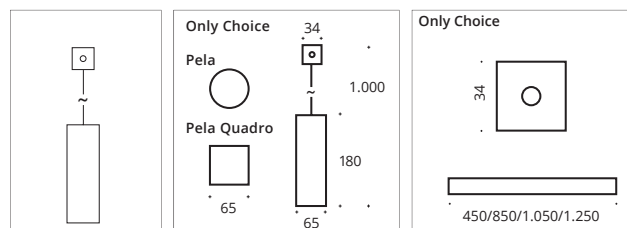



Look at me



Look at me

LED-Pendelleuchte mit 8 Watt und ~600 Lumen. Pendellänge ca. 1.300 mm, Standard-Textilkabel in anthrazit. EU Verordnung 874/2012, enthält eingebaute LED.

LED - pendant luminaire with 8 Watt and ~600 Lumen. Pendant length approx. 1300 mm, with textile cable in anthracite as standard. EU Regulation 874/2012 , contains built-in LED.

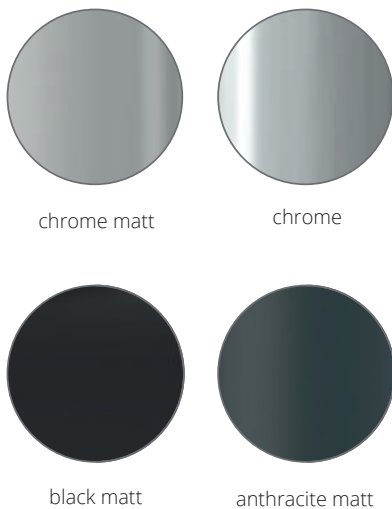

chrome matt

chrome

black matt

anthracite matt



Optional Kabelvarianten.
Optional cable.



white matt

Look at me Single

Single LED G 8W ~600lm ~2.700k	Single IP44 LED G 8W ~600lm ~2.700k	H x Ø H x Ø in mm	Gehäuse body
● 5-911-1	5-911-1-IP	215 x 85	chrommatt
● 5-911-2	5-911-2-IP	215 x 85	chrome
● 5-911-2-22	5-911-2-IP-22	215 x 85	white matt
● 5-911-2-02	5-911-2-IP-02	215 x 85	black matt
● 5-911-2-23	5-911-2-IP-23	215 x 85	anthracite matt

Look at me Trio

Trio LED G 8W ~1.800lm ~2.700k	Trio IP44 LED G 8W ~1.800lm ~2.700k	H x Ø H x Ø in mm	Gehäuse body
● 5-9113-1	5-9113-1-IP	215 x 85	chrommatt
● 5-9113-2	5-9113-2-IP	215 x 85	chrome
● 5-9113-2-22	5-9113-2-IP-22	215 x 85	white matt
● 5-9113-2-02	5-9113-2-IP-02	215 x 85	black matt
● 5-9113-2-23	5-9113-2-IP-23	215 x 85	anthracite matt

Art. Nr. item no.	Beschreibung description
2-9126	Lins klar, lens clear
2-9126-S	Linse einseitig mattiert lens satined on one side

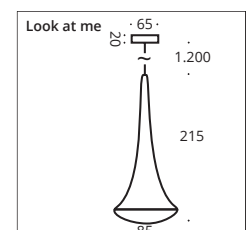

IP20: ABC (s.S 6-7/s.p. 6-7)
IP44: BC (s.S 6-7/s.p. 6-7)





Look at me Choice

Lichtbalken für direkte Montage an der Decke. Bestückt mit Look at me Leuchten. Pendelleuchten aus der Top Light Serie. Pendellänge ca. 1.300 mm, Standard-Textilkabel in anthrazit.

Light bar for direct mounting on the ceiling. Equipped with Look at me heads. Pendant luminaires of the Top Light series. Pendant length approx. 1300 mm, with textile cable in anthracite as standard.

INDOOR

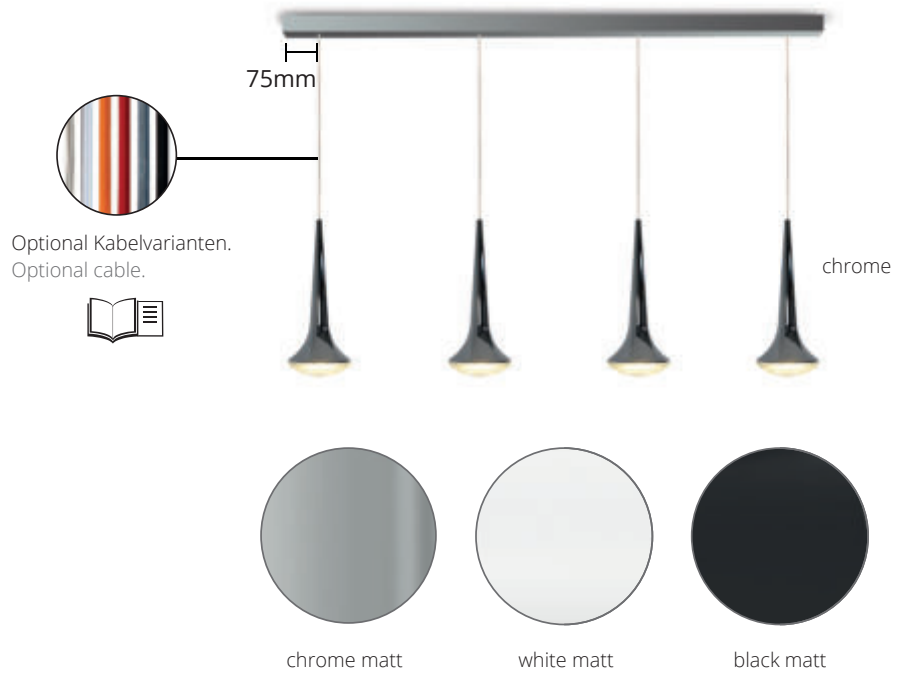

Look at me LED

450 mm L 2 Köpfe/heads G 16W ~1.200lm ~2.700k	850 mm L 3 Köpfe/heads G 24W ~1.800lm ~2.700k	1.050 mm L 4 Köpfe/heads G 32W ~2.400lm ~2.700k	1.250 mm L 4 Köpfe/heads G 32W ~2.400lm ~2.700k	Gehäuse body
8-794021	8-798031	8-7910041	8-7912041	chrome matt
8-794022	8-798032	8-7910042	8-7912042	chrome
8-794022-22	8-798032-22	8-7910042-22	8-7912042-22	white matt
8-794022-02	8-798032-02	8-7910042-02	8-7912042-02	black matt

Farbig gepulverter Lichtbalken = Preis auf Anfrage. Color powdered metal rail

Sonderanfertigung:

Art-Nr. 8-600 Kürzung auf Maß

Item No. 8-600 Customized lengths



C (s.S 6-7/s.p. 6-7)

□ Chrom Teile/
chrome parts
■ Gepulverte Teile/
powder-coating

Equipment

Art. Nr. item no.	Einsatz insert	Beschreibung description
2-9126	Linse	klar, clear
2-9126-S	lens	einseitig mattiert, satinated on one side

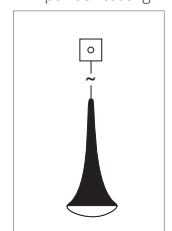
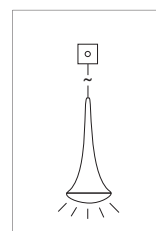
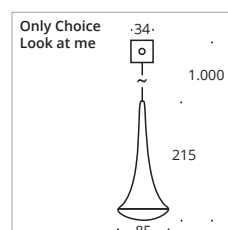
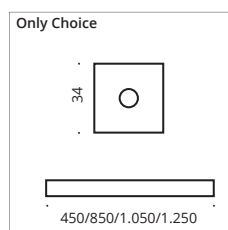



Puk Mini Floor Mini Twin

STEHLEUCHTEN

FLOOR LAMPS



Puk Mini Eye Floor 241
Puk Maxx Eye Floor 243
Puk Meg Maxx Eye Floor 245



Puk Mini Floor Mini 247
Puk Maxx Floor Mini 249



Puk Mini Floor Sister 251
Puk Maxx Floor Sister 253



Puk Mini Floor Maxi 255
Puk Maxx Floor Maxi 257



Puk Mini Floor Mother-Kid 259
Puk Maxx Floor Mother-Kid 261



Sun Floor 263/265



Puk Mini Eye Floor



Puk Mini Eye Floor \varnothing 80

Stand- und Leseleuchte, G9 Fassung (mit Schalter, Dimmer optional) oder LED Niedervolt mit Tast-Dimmer. Fest verbaute untere Linse. Die Standardausstattung ist mit schwarzem Textilkabel.

Floor and reading lamp, G9 socket (with switch, dimmer optional) or LED low voltage with touch dimmer. Fixed lower lens. Supplied as standard with black textile cable.

INDOOR

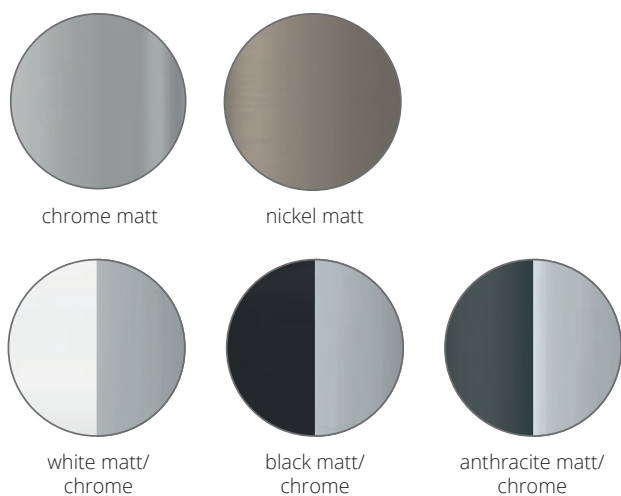

Puk Mini Eye G9 Fassung ON/OFF	Puk Mini Eye NV LED 20W ~2x900lm ~2.700k	Höhe height in mm	Gehäuse body
6-0813201-G9	6-0813201-NV-LED	1320	chrome matt
6-0813202-G9	6-0813202-NV-LED	1320	chrome
6-0813203-G9	6-0813203-NV-LED	1320	nickel matt
6-0813202-22-G9	6-0813202-NV-LED-22	1320	white matt/chrome
6-0813202-02-G9	6-0813202-NV-LED-02	1320	black matt/chrome
6-0813202-23-G9	6-0813202-NV-LED-23	1320	anthracite matt/chr.

Für Schnur-Dimmer bei G9 Leuchte »-D« an die Art.-Nr. hängen (Hochvolt)
Attach »-D« behind the item no. for a G9 cable dimmer (high voltage)

Die LED Niedervolt Leuchten sind standardmäßig mit Tast-Dimmer ausgestattet
The LED low voltage luminaires are standard equipped with touch dimmer

► Ohne Zubehör. Bestell-Artikelnummern für Linse, Glas, Farbfilter und die Konfigurationsempfehlung auf der Einklappseite!

► Without accessories: Order item-no. for lens, glass, color filter and the recommended Configuration are on the fold-in page!

Leuchtmittelangabe: LED Retrofit **G inkl.** ~3Watt ~300lm ~2.700K | G9 max. 33W ECO lamp information: LED Retrofit **G incl.** ~3Watt ~300lm ~2.700K | G9 max. 33W ECO

Leuchtmittlempfehlung: LED max. 3W/300lm/2.700K/dimmbar **G** Art. Nr. 8-205 bulb recommendation: LED max. 3W/300Lm/2.700K/dimmable **G** Item No. 8-205



Optional Kabelvarianten.
Optional cable.

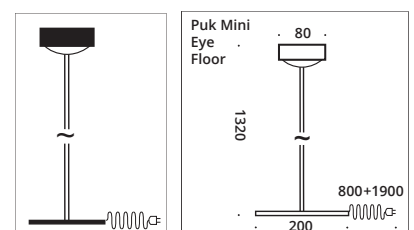
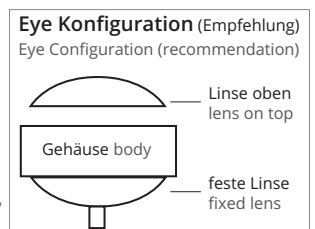



Puk Maxx Eye Floor



Puk Maxx Eye Floor ø 120

Stand- und Leseleuchte, G9 Fassung (mit Schalter, Dimmer optional) oder LED Niedervolt mit Tast-Dimmer. Fest verbaute untere Linse. Die Standardausstattung ist mit schwarzem Textilkabel.

Floor and reading lamp, G9 socket (with switch, dimmer optional) or LED low voltage with touch dimmer. Fixed lower lens. Supplied as standard with black textile cable.

INDOOR

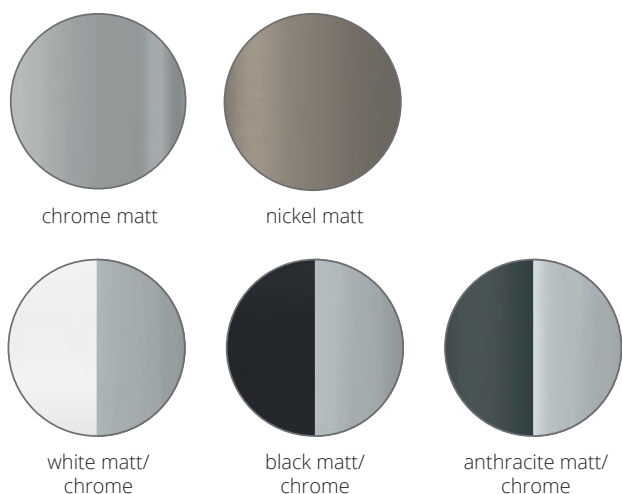

Puk Maxx Eye G9 Fassung ON/OFF	Puk Maxx Eye NV LED 20W ~2x900lm ~2.700k	Höhe height in mm	Gehäuse body
6-3813201-G9	6-3813201-NV-LED	1.320	chrome matt
6-3813202-G9	6-3813202-NV-LED	1.320	chrome
6-3813203-G9	6-3813203-NV-LED	1.320	nickel matt
6-3813202-22-G9	6-3813202-NV-LED-22	1.320	white matt/chrome
6-3813202-02-G9	6-3813202-NV-LED-02	1.320	black matt/chrome
6-3813202-23-G9	6-3813202-NV-LED-23	1.320	anthracite matt/chr.

Für Schnur-Dimmer bei G9 Leuchte »-D« an die Art.-Nr. hängen (Hochvolt)
Attach »-D« behind the item no. for a G9 cable dimmer (high voltage)

Die LED Niedervolt Leuchten sind standardmäßig mit Tast-Dimmer ausgestattet
The LED low voltage luminaires are standard equipped with touch dimmer

► Ohne Zubehör. Bestell-Artikelnummern für Linse, Glas, Farbfilter und die Konfigurationsempfehlung auf der Einklappseite!

► Without accessories: Order item-no. for lens, glass, color filter and the recommended Configuration are on the fold-in page!



Leuchtmittelangabe: LED Retrofit **G inkl.** ~3Watt ~300lm ~2.700K | G9 max. 33W ECO
lamp information: LED Retrofit **G incl.** ~3Watt ~300lm ~2.700K | G9 max. 33W ECO

Leuchtmittelempfehlung: LED max. 3W/300lm/2.700K/dimmbar **G** Art. Nr. 8-205
bulb recommendation: LED max. 3W/300Lm/2.700K/dimmable **G** Item No. 8-205



Optional Kabelvarianten.
Optional cable.



Eye Konfiguration (Empfehlung)
Eye Configuration (recommendation)

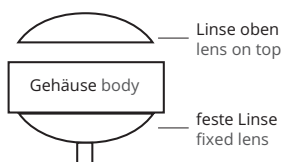

Chrom Teile/
chrome parts

Gepulverte Teile/
powder-coating

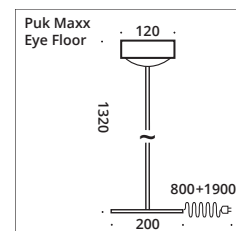
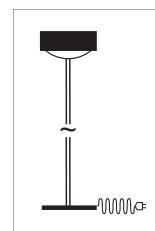



Puk Meg Maxx Eye Floor









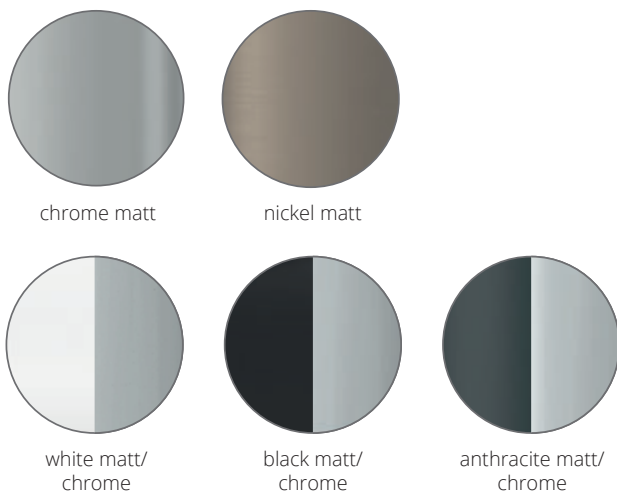

Puk Meg Maxx Eye Floor \varnothing 160

Stand- und Leseleuchte, G9 Fassung (mit Schalter, Dimmer optional) oder LED Niedervolt mit Tast-Dimmer. Fest verbaute untere Linse. Die Standardausstattung ist mit schwarzem Textilkabel.

Floor and reading lamp, G9 socket (with switch, dimmer optional) or LED low voltage with touch dimmer. Fixed lower lens. Supplied as standard with black textile cable.

INDOOR



Puk Meg Maxx Eye G9 Fassung  ON/OFF	Puk Meg Maxx Eye NV LED  20W ~2x900lm ~2.700k	Höhe height in mm	Gehäuse body
 6-4013201-G9	6-4013201-NV-LED	1.320	chrome matt
 6-4013202-G9	6-4013202-NV-LED	1.320	chrome
 6-4013203-G9	6-4013203-NV-LED	1.320	nickel matt
 6-4013202-22-G9	6-4013202-NV-LED-22	1.320	white matt/chrome
 6-4013202-02-G9	6-4013202-NV-LED-02	1.320	black matt/chrome
 6-4013202-23-G9	6-4013202-NV-LED-23	1.320	anthracite matt/chr.

Für Schnur-Dimmer bei G9 Leuchte »-D« an die Art.-Nr. hängen (Hochvolt)
Attach »-D« behind the item no. for a G9 cable dimmer (high voltage)

Die LED Niedervolt Leuchten sind standardmäßig mit Tast-Dimmer ausgestattet
The LED low voltage luminaires are standard equipped with touch dimmer

- ▶ Ohne Zubehör. Bestell-Artikelnummern für Linse, Glas, Farbfilter und die Konfigurationsempfehlung auf der Einklappseite!
- ▶ Without accessories: Order item-no. for lens, glass, color filter and the recommended Configuration are on the fold-in page!



 Leuchtmittelangabe: LED Retrofit **G inkl.** ~3Watt ~300lm ~2.700K | G9 max. 33W ECO
lamp information: LED Retrofit **G incl.** ~3Watt ~300lm ~2.700K | G9 max. 33W ECO

 Leuchtmittlempfehlung: LED max. 3W/300lm/2.700K/dimmbar **G** Art. Nr. 8-205
bulb recommendation: LED max. 3W/300Lm/2.700K/dimmable **G** Item No. 8-205

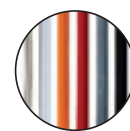



Optional Kabelvarianten.
Optional cable.

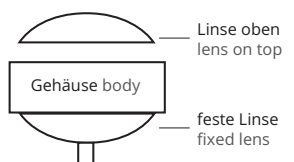

Eye Konfiguration (Empfehlung)
Eye Configuration (recommendation)



-  Chrom Teile/
chrome parts
-  Gepulverte Teile/
powder-coating

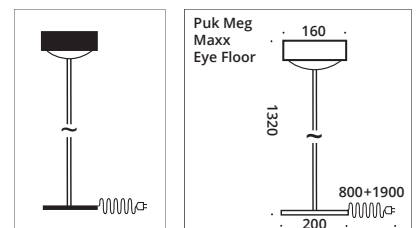



Puk Mini Floor Mini Single



Puk Mini Floor Mini ø 80

Stand- und Leseleuchte, G9 Fassung (mit Schalter, Dimmer optional) oder LED Niedervolt mit Tast-Dimmer, Kopf drehbar mit Verstellstift. Arm schwenkbar. Die Standardausstattung ist mit schwarzem Textilkabel.

Floor and reading lamp, G9 socket (with switch, dimmer optional) or LED low voltage with touch dimmer. Head rotatable with adjustment pin, arm pivotable. Supplied as standard with black textile cable.

INDOOR

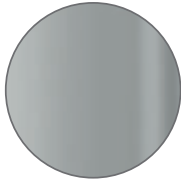

chrome matt

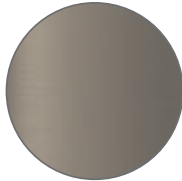

nickel matt

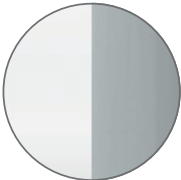

white matt/
chrome

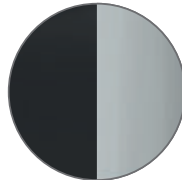

black matt/
chrome

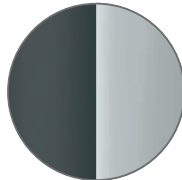

anthracite matt/
chrome



chrome

Puk Mini Floor Mini G9 Fassung ON/OFF	Puk Mini Floor Mini NV LED ~2.700k	Armlänge arm length in mm	Gehäuse body
Single	Single 20W ~2x900lm		
6-081201-1-G9	6-081201-1-NV-LED	1.250	chrome matt
6-081202-1-G9	6-081202-1-NV-LED	1.250	chrome
6-081203-1-G9	6-081203-1-NV-LED	1.250	nickel matt
6-081202-1-22-G9	6-081202-1-NV-LED-22	1.250	white matt/chr.
6-081202-1-02-G9	6-081202-1-NV-LED-02	1.250	black matt/chr.
6-081202-1-23-G9	6-081202-1-NV-LED-23	1.250	anthracite matt/chr.
Twin	Twin 20W ~4x600lm		
6-081201-2-G9	6-081201-2-NV-LED	1.250	chrome matt
6-081202-2-G9	6-081202-2-NV-LED	1.250	chrome
6-081203-2-G9	6-081203-2-NV-LED	1.250	nickel matt
6-081202-2-22-G9	6-081202-2-NV-LED-22	1.250	white matt/chr.
6-081202-2-02-G9	6-081202-2-NV-LED-02	1.250	black matt/chr.
6-081202-2-23-G9	6-081202-2-NV-LED-23	1.250	anthracite matt/chr.

Für Schnur-Dimmer bei G9 Leuchte »-D« an die Art.-Nr. hängen (Hochvolt)
Attach »-D« behind the item no. for a G9 cable dimmer (high voltage)

Die LED Niedervolt Leuchten sind standardmäßig mit Tast-Dimmer ausgestattet
The LED low voltage luminaires are standard equipped with touch dimmer

- ▶ Ohne Zubehör. Bestell-Artikelnummern für Linse, Glas, Farbfilter und die Konfigurationsempfehlung auf der Einklappseite!
- ▶ Without accessories: Order item-no. for lens, glass, color filter and the recommended Configuration are on the fold-in page!



Leuchtmittelangabe: LED Retrofit **G inkl.** ~3Watt ~300lm ~2.700K | G9 max. 33W ECO
lamp information: LED Retrofit **G incl.** ~3Watt ~300lm ~2.700K | G9 max. 33W ECO

Leuchtmittelpfehlung: LED max. 3W/300lm/2.700K/dimmbar **G** Art. Nr. 8-205
bulb recommendation: LED max. 3W/300Lm/2.700K/dimmable **G** Item No. 8-205

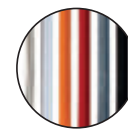

Optional Kabelvarianten.
Optional cable.



- Chrom Teile/
chrome parts
- Gepulverte Teile/
powder-coating

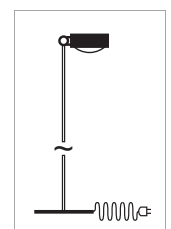
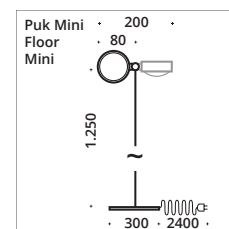



Puk Maxx Floor Mini



Puk Maxx Floor Mini ø 120

Stand- und Leseleuchte, G9 Fassung (mit Schalter, Dimmer optional) oder LED Niedervolt mit Tast-Dimmer, Kopf drehbar mit Verstellstift. Arm schwenkbar. Die Standardausstattung ist mit schwarzem Textilkabel.

Floor and reading lamp, G9 socket (with switch, dimmer optional) or LED low voltage with touch dimmer. Head rotatable with adjustment pin, arm pivotable. Supplied as standard with black textile cable.

INDOOR

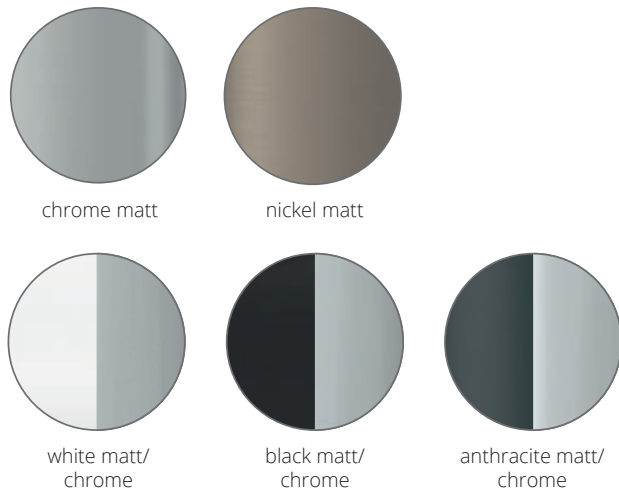

chrome

Puk Maxx Floor Mini G9 Fassung ON/OFF	Puk Maxx Floor Mini NV LED	Armlänge arm length in mm	Gehäuse body
6-381201-G9	6-381201-NV-LED	1.250	chrome matt
6-381202-G9	6-381202-NV-LED	1.250	chrome
6-381203-G9	6-381203-NV-LED	1.250	nickel matt
6-381202-22-G9	6-381202-NV-LED-22	1.250	white matt/chr.
6-381202-02-G9	6-381202-NV-LED-02	1.250	black matt/chr.
6-381202-23-G9	6-381202-NV-LED-23	1.250	anthracite matt/chr.

Für Schnur-Dimmer bei G9 Leuchte »-D« an die Art.-Nr. hängen (Hochvolt)
Attach »-D« behind the item no. for a G9 cable dimmer (high voltage)

Die LED Niedervolt Leuchten sind standardmäßig mit Tast-Dimmer ausgestattet
The LED low voltage luminaires are standard equipped with touch dimmer

- ▶ Ohne Zubehör. Bestell-Artikelnummern für Linse, Glas, Farbfilter und die Konfigurationsempfehlung auf der Einklappseite!
- ▶ Without accessories: Order item-no. for lens, glass, color filter and the recommended Configuration are on the fold-in page!



Leuchtmittelangabe: LED Retrofit **G inkl.** ~3Watt ~300lm ~2.700K | G9 max. 33W ECO
lamp information: LED Retrofit **G incl.** ~3Watt ~300lm ~2.700K | G9 max. 33W ECO

Leuchtmittelempfehlung: LED max. 3W/300lm/2.700K/dimmbar **G** Art. Nr. 8-205
bulb recommendation: LED max. 3W/300lm/2.700K/dimmable **G** Item No. 8-205



Optional Kabelvarianten.
Optional cable.



- Chrom Teile/
chrome parts
- Gepulverte Teile/
powder-coating

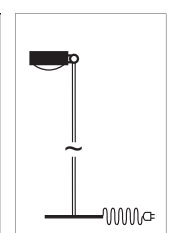
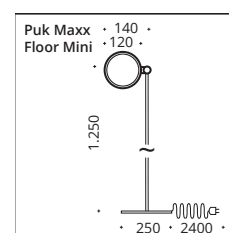

C (s.S 6-7/s.p. 6-7)





Puk Mini Floor Sister ø 80

Stand- und Leseleuchte, G9 Fassung (mit Schalter, Dimmer optional) oder LED Niedervolt mit Tast-Dimmer, Köpfe drehbar mit Verstellstift. Arme schwenkbar. Die Standardausstattung ist mit schwarzem Textilkabel.

Floor and reading lamp, G9 socket (with switch, dimmer optional) or LED low voltage with touch dimmer. Head rotatable with adjustment pin, arm pivotable. Supplied as standard with black textile cable.

INDOOR

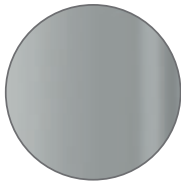

chrome matt



nickel matt

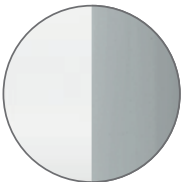

white matt/
chrome

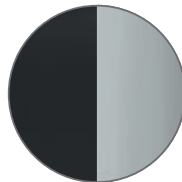

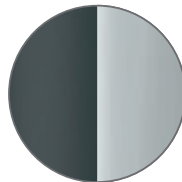

black matt/
chrome



anthracite matt/
chrome



chrome

Puk Mini Floor Sister G9 Fassung  ON/OFF	Puk Mini Floor Sister NV LED 	Armlänge arm length in mm	Gehäuse body
6-0821201-G9	6-0821201-NV-LED	2 x 1.250	chrome matt
6-0821202-G9	6-0821202-NV-LED	2 x 1.250	chrome
6-0821203-G9	6-0821203-NV-LED	2 x 1.250	nickel matt
6-0821202-22-G9	6-0821202-NV-LED-22	2 x 1.250	white matt/chr.
6-0821202-02-G9	6-0821202-NV-LED-02	2 x 1.250	black matt/chr.
6-0821202-23-G9	6-0821202-NV-LED-23	2 x 1.250	anthracite matt /chr.

Für Schnur-Dimmer bei G9 Leuchte »-D« an die Art.-Nr. hängen (Hochvolt)
Attach »-D« behind the item no. for a G9 cable dimmer (high voltage)

Die LED Niedervolt Leuchten sind standardmäßig mit Tast-Dimmer ausgestattet
The LED low voltage luminaires are standard equipped with touch dimmer

► Ohne Zubehör. Bestell-Artikelnummern für Linse, Glas, Farbfilter und die Konfigurationsempfehlung auf der Einklappseite!





► Without accessories: Order item-no. for lens, glass, color filter and the recommended Configuration are on the fold-in page!

 Leuchtmittelangabe: LED Retrofit **G inkl.** ~3Watt ~300lm ~2.700K | G9 max. 33W ECO
lamp information: LED Retrofit **G incl.** ~3Watt ~300lm ~2.700K | G9 max. 33W ECO

 Leuchtmittelempfehlung: LED max. 3W/300lm/2.700K/dimmbar **G** Art. Nr. 8-205
bulb recommendation: LED max. 3W/300Lm/2.700K/dimmable **G** Item No. 8-205



C (s.S 6-7/s.p. 6-7)

 Chrom Teile/
chrome parts
 Gepulverte Teile/
powder-coating

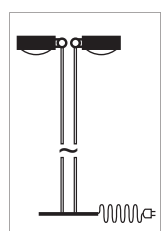
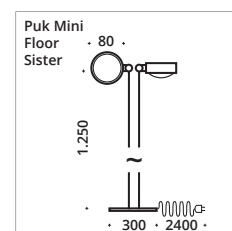





Puk Maxx Floor Sister ø 120

Stand- und Leseleuchte, G9 Fassung (mit Schalter, Dimmer optional) oder LED Niedervolt mit Tast-Dimmer, Köpfe drehbar mit Verstellstift. Arme schwenkbar. Die Standardausstattung ist mit schwarzem Textilkabel.

Floor and reading lamp, G9 socket (with switch, dimmer optional) or LED low voltage with touch dimmer. Head rotatable with adjustment pin, arm pivotable. Supplied as standard with black textile cable.

INDOOR

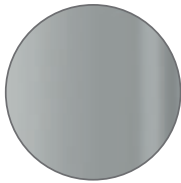

chrome matt

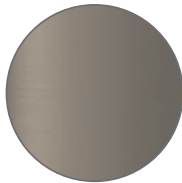

nickel matt

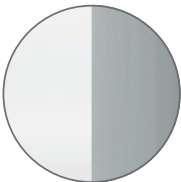

white matt/
chrome

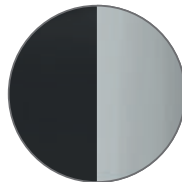

black matt/
chrome

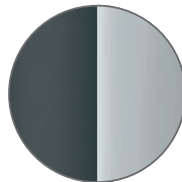

anthracite matt/
chrome



chrome

Puk Maxx Floor Sister G9 Fassung ON/OFF	Puk Maxx Floor Sister NV LED 2x20W ~4x900lm ~2.700k	Armlänge arm length in mm	Gehäuse body
6-3821201-G9	6-3821201-NV-LED	2 x 1.250	chrome matt
6-3821202-G9	6-3821202-NV-LED	2 x 1.250	chrome
6-3821203-G9	6-3821203-NV-LED	2 x 1.250	nickel matt
6-3821202-22-G9	6-3821202-NV-LED-22	2 x 1.250	white matt/chr.
6-3821202-02-G9	6-3821202-NV-LED-02	2 x 1.250	black matt/chr.
6-3821202-23-G9	6-3821202-NV-LED-23	2 x 1.250	anthracite matt/chr.

Für Schnur-Dimmer bei G9 Leuchte »-D« an die Art.-Nr. hängen (Hochvolt)
Attach »-D« behind the item no. for a G9 cable dimmer (high voltage)

Die LED Niedervolt Leuchten sind standardmäßig mit Tast-Dimmer ausgestattet
The LED low voltage luminaires are standard equipped with touch dimmer

- ▶ Ohne Zubehör. Bestell-Artikelnummern für Linse, Glas, Farbfilter und die Konfigurationsempfehlung auf der Einklappseite!
- ▶ Without accessories: Order item-no. for lens, glass, color filter and the recommended Configuration are on the fold-in page!



Leuchtmittelangabe: LED Retrofit **G inkl.** ~3Watt ~300lm ~2.700K | G9 max. 33W ECO
lamp information: LED Retrofit **G incl.** ~3Watt ~300lm ~2.700K | G9 max. 33W ECO

Leuchtmittlempfehlung: LED max. 3W/300lm/2.700K/dimmbar Art. Nr. 8-205
bulb recommendation: LED max. 3W/300Lm/2.700K/dimmable Item No. 8-205



C (s.S 6-7/s.p. 6-7)

- Chrom Teile/
chrome parts
- Gepulverte Teile/
powder-coating

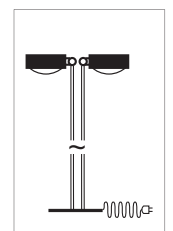
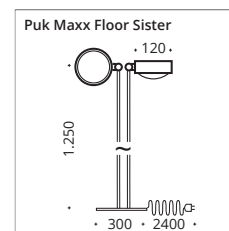





Puk Mini Floor Maxi Ø 80

Stand- und Leseleuchte, G9 Fassung (mit Schalter, Dimmer optional) oder LED Niedervolt mit Tast-Dimmer, Köpfe drehbar mit Verstellstift. Arm schwenkbar. Die Standardausstattung ist mit schwarzem Textilkabel.

Floor and reading lamp, G9 socket (with switch, dimmer optional) or LED low voltage with touch dimmer. Head rotatable with adjustment pin, arm pivotable. Supplied as standard with black textile cable.

INDOOR

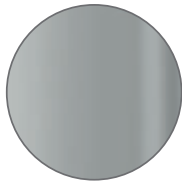

chrome matt

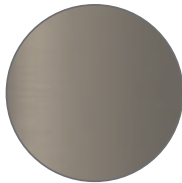

nickel matt

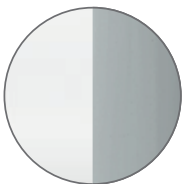

white matt/
chrome

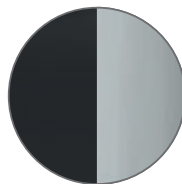

black matt/
chrome

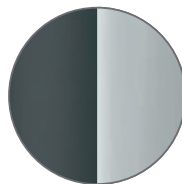

anthracite matt/
chrome



chrome

Puk Mini Floor Maxi G9 Fassung ON/OFF	Puk Mini Floor Maxi NV LED ~2.700k	Armlänge arm length in mm	Gehäuse body
Single	Single 20W ~2x900lm		
6-081801-1-G9	6-081801-1-NV-LED	1.800	chrome matt
6-081802-1-G9	6-081802-1-NV-LED	1.800	chrome
6-081803-1-G9	6-081803-1-NV-LED	1.800	nickel matt
6-081802-1-22-G9	6-081802-1-NV-LED-22	1.800	white matt/chr.
6-081802-1-02-G9	6-081802-1-NV-LED-02	1.800	black matt/chr.
6-081802-1-23-G9	6-081802-1-NV-LED-23	1.800	anthracite matt/chr.
Twin	Twin 20W ~4x600lm		
6-081801-2-G9	6-081801-2-NV-LED	1.800	chrome matt
6-081802-2-G9	6-081802-2-NV-LED	1.800	chrome
6-081803-2-G9	6-081803-2-NV-LED	1.800	nickel matt
6-081802-2-22-G9	6-081802-2-NV-LED-22	1.800	white matt/chr.
6-081802-2-02-G9	6-081802-2-NV-LED-02	1.800	black matt/chr.
6-081802-2-23-G9	6-081802-2-NV-LED-23	1.800	anthracite matt/chr.

Für Schnur-Dimmer bei G9 Leuchte »-D« an die Art.-Nr. hängen (Hochvolt)
Attach »-D« behind the item no. for a G9 cable dimmer (high voltage)

Die LED Niedervolt Leuchten sind standardmäßig mit Tast-Dimmer ausgestattet
The LED low voltage luminaires are standard equipped with touch dimmer

- ▶ Ohne Zubehör. Bestell-Artikelnummern für Linse, Glas, Farbfilter und die Konfigurationsempfehlung auf der Einklappseite!
- ▶ Without accessories: Order item-no. for lens, glass, color filter and the recommended Configuration are on the fold-in page!



Leuchtmittelangabe: LED Retrofit **G inkl.** ~3Watt ~300lm ~2.700K | G9 max. 33W ECO
lamp information: LED Retrofit **G incl.** ~3Watt ~300lm ~2.700K | G9 max. 33W ECO

Leuchtmittelempfehlung: LED max. 3W/300lm/2.700K/dimmbar **G** Art. Nr. 8-205
bulb recommendation: LED max. 3W/300lm/2.700K/dimmable **G** Item No. 8-205



Optional Kabelvarianten.
Optional cable.



- Chrom Teile/
chrome parts
- Gepulverte Teile/
powder-coating

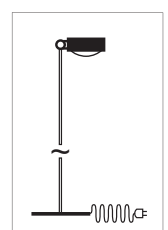
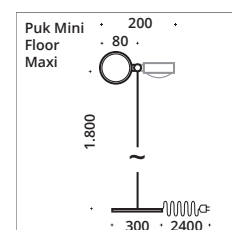





Puk Maxx Floor Maxi ø 120

Stand- und Leseleuchte, G9 Fassung (mit Schalter, Dimmer optional) oder LED Niedervolt mit Tast-Dimmer, Kopf drehbar mit Verstellstift. Arm schwenkbar. Die Standardausstattung ist mit schwarzem Textilkabel.

Floor and reading lamp, G9 socket (with switch, dimmer optional) or LED low voltage with touch dimmer. Head rotatable with adjustment pin, arm pivotable. Supplied as standard with black textile cable.

INDOOR

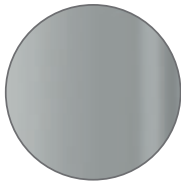

chrome matt

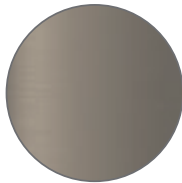

nickel matt

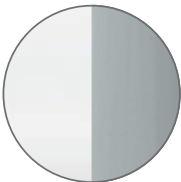

white matt/
chrome

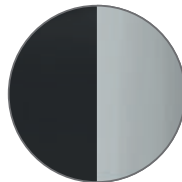

black matt/
chrome

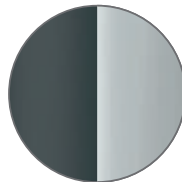

anthracite matt/
chrome

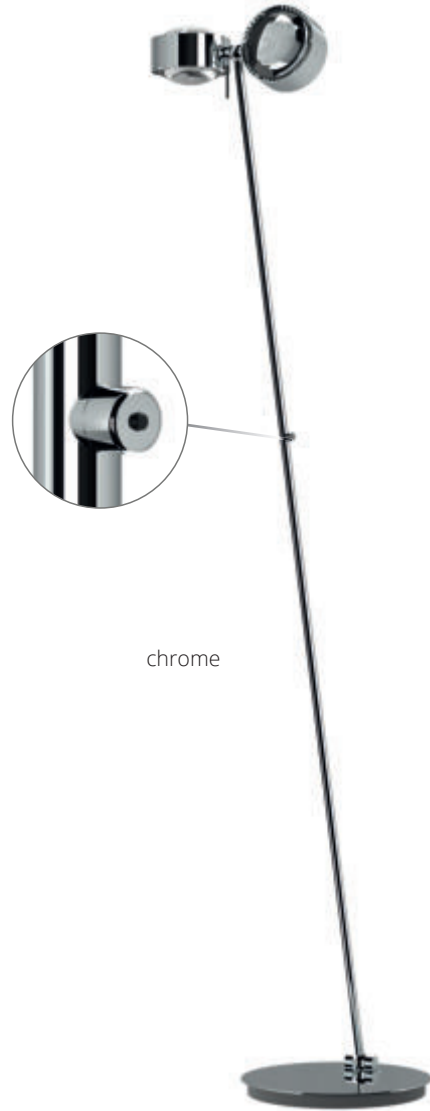

chrome

Puk Maxx Floor Maxi G9 Fassung ON/OFF	Puk Maxx Floor Maxi NV LED ~2.700k	Armlänge arm length in mm	Gehäuse body
Single	Single 20W ~2x900lm		
6-381801-G9	6-381801-NV-LED	1.800	chrome matt
6-381802-G9	6-381802-NV-LED	1.800	chrome
6-381803-G9	6-381803-NV-LED	1.800	nickel matt
6-381802-22-G9	6-381802-NV-LED-22	1.800	white matt/chr.
6-381802-02-G9	6-381802-NV-LED-02	1.800	black matt/chr.
6-381802-23-G9	6-381802-NV-LED-23	1.800	anthracite matt/chr.
Twin	Twin 20W ~4x600lm		
6-3818021-G9	6-3818021-NV-LED	1.800	chrome matt
6-3818022-G9	6-3818022-NV-LED	1.800	chrome
6-3818023-G9	6-3818023-NV-LED	1.800	nickel matt
6-3818022-22-G9	6-3818022-NV-LED-22	1.800	white matt/chr.
6-3818022-02-G9	6-3818022-NV-LED-02	1.800	black matt/chr.
6-3818022-23-G9	6-3818022-NV-LED-23	1.800	anthracite matt/chr.

Für Schnur-Dimmer bei G9 Leuchte »-D« an die Art.-Nr. hängen (Hochvolt)
Attach »-D« behind the item no. for a G9 cable dimmer (high voltage)

Die LED Niedervolt Leuchten sind standardmäßig mit Tast-Dimmer ausgestattet
The LED low voltage luminaires are standard equipped with touch dimmer

► Ohne Zubehör. Bestell-Artikelnummern für Linse, Glas, Farbfilter und die Konfigurationsempfehlung auf der Einklappseite!



► Without accessories: Order item-no. for lens, glass, color filter and the recommended Configuration are on the fold-in page!

Leuchtmittelangabe: LED Retrofit **G inkl.** ~3Watt ~300lm ~2.700K | G9 max. 33W ECO
lamp information: LED Retrofit **G incl.** ~3Watt ~300lm ~2.700K | G9 max. 33W ECO

Leuchtmittelpfehlung: LED max. 3W/300lm/2.700K/dimmbar **G** Art. Nr. 8-205
bulb recommendation: LED max. 3W/300Lm/2.700K/dimmable **G** Item No. 8-205



Optional Kabelvarianten.
Optional cable.



Chrom Teile/
chrome parts
 Gepulverte Teile/
powder-coating

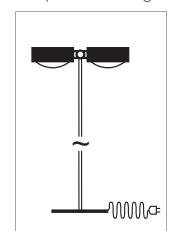
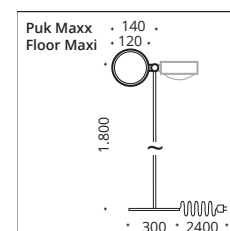





Puk Mini Floor Mother-Kid ø 80

Stand- und Leseleuchte, G9 Fassung (mit Schalter, Dimmer optional) oder LED Niedervolt mit Tast-Dimmer, Köpfe drehbar mit Verstellstift. Arme schwenkbar. Die Standardausstattung ist mit schwarzem Textilkabel.

Floor and reading lamp, G9 socket (with switch, dimmer optional) or LED low voltage with touch dimmer. Heads rotatable with adjustment pin, arm pivotable. Supplied as standard with black textile cable.

INDOOR

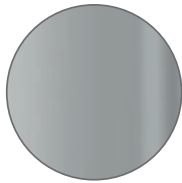

chrome matt

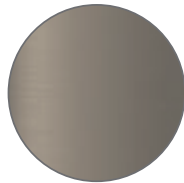

nickel matt

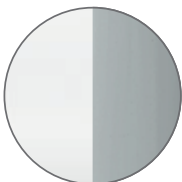

white matt/
chrome

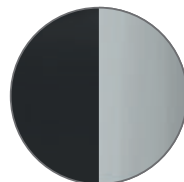

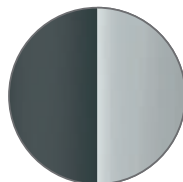

black matt/
chrome



anthracite
matt/chrome



chrome

Puk Mini Floor Mother-Kid G9 Fassung  ON/OFF	Puk Mini Floor Mother-Kid NV LED 	Armlänge arm length in mm	Gehäuse body
6-082180120-1-G9	6-082180120-1-NV-LED	1.800 + 1.250	chrome matt
6-082180120-2-G9	6-082180120-2-NV-LED	1.800 + 1.250	chrome
6-082180120-3-G9	6-082180120-3-NV-LED	1.800 + 1.250	nickel matt
6-082180120-2-22-G9	6-082180120-2-NV-LED-22	1.800 + 1.250	white matt/chr.
6-082180120-2-02-G9	6-082180120-2-NV-LED-02	1.800 + 1.250	black matt/chr.
6-082180120-2-23-G9	6-082180120-2-NV-LED-23	1.800 + 1.250	anthracite matt/chr.

Für Schnur-Dimmer bei G9 Leuchte »-D« an die Art.-Nr. hängen (Hochvolt)
Attach »-D« behind the item no. for a G9 cable dimmer (high voltage)

Die LED Niedervolt Leuchten sind standardmäßig mit Tast-Dimmer ausgestattet
The LED low voltage luminaires are standard equipped with touch dimmer

- ▶ Ohne Zubehör. Bestell-Artikelnummern für Linse, Glas, Farbfilter und die Konfigurationsempfehlung auf der Einklappseite!
- ▶ Without accessories: Order item-no. for lens, glass, color filter and the recommended Configuration are on the fold-in page!



 Leuchtmittelangabe: LED Retrofit **G inkl.** ~3Watt ~300lm ~2.700K | G9 max. 33W ECO
lamp information: LED Retrofit **G incl.** ~3Watt ~300lm ~2.700K | G9 max. 33W ECO

 Leuchtmittlempfehlung: LED max. 3W/300lm/2.700K/dimmbar **G** Art. Nr. 8-205
bulb recommendation: LED max. 3W/300lm/2.700K/dimmable **G** Item No. 8-205

- Chrom Teile/
chrome parts
- Gepulverte Teile/
powder-coating

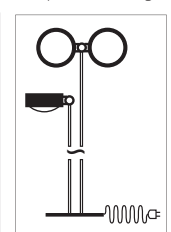
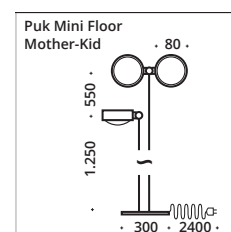

C (s.S 6-7/s.p. 6-7)



Puk Maxx Floor Mother-Kid



Puk Maxx Floor Mother-Kid ø 120

Stand- und Leseleuchte, G9 Fassung (mit Schalter, Dimmer optional) oder LED Niedervolt mit Tast-Dimmer, Köpfe drehbar mit Verstellstift. Arme schwenkbar. Die Standardausstattung ist mit schwarzem Textilkabel.

Floor and reading lamp, G9 socket (with switch, dimmer optional) or LED low voltage with touch dimmer. Heads rotatable with adjustment pin, arm pivotable. Supplied as standard with black textile cable.

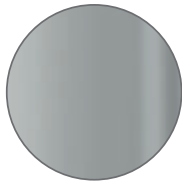

chrome matt

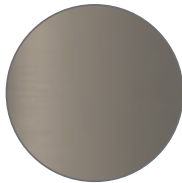

nickel matt

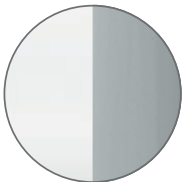

white matt/
chrome

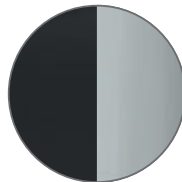

black matt/
chrome

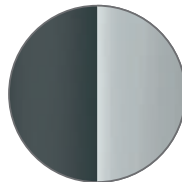

anthracite matt/
chrome



chrome

Puk Maxx Floor Mother-Kid G9 Fassung	Puk Maxx Floor Mother-Kid NV LED	Armlängen arm lengths in mm	Gehäuse body
ON/OFF	20W ~2x900lm 20W ~4x600lm ~2.700k		
6-3821801201-G9	6-3821801201-NV-LED	1.800 + 1.250	chrome matt
6-3821801202-G9	6-3821801202-NV-LED	1.800 + 1.250	chrome
6-3821801203-G9	6-3821801203-NV-LED	1.800 + 1.250	nickel matt
6-3821801202-22-G9	6-3821801202-NV-LED-22	1.800 + 1.250	white matt/chr.
6-3821801202-02-G9	6-3821801202-NV-LED-02	1.800 + 1.250	black matt/chr.
6-3821801202-23-G9	6-3821801202-NV-LED-23	1.800 + 1.250	anthracite matt/chr.

Für Schnurschiebe-Dimmer bei G9 Leuchte »-D« an die Art.-Nr. hängen (Hochvolt)
Attach »-D« behind the item no. for a G9 cable dimmer (high voltage)

Die LED Niedervolt Leuchten sind standardmäßig mit Tast-Dimmer ausgestattet
The LED low voltage luminaires are standard equipped with touch dimmer

► Ohne Zubehör. Bestell-Artikelnummern für Linse, Glas, Farbfilter und die Konfigurationsempfehlung auf der Einklappseite!

► Without accessories: Order item-no. for lens, glass, color filter and the recommended Configuration are on the fold-in page!



Leuchtmittelangabe: LED Retrofit **G inkl.** ~3Watt ~300lm ~2.700K | G9 max. 33W ECO
lamp information: LED Retrofit **G incl.** ~3Watt ~300lm ~2.700K | G9 max. 33W ECO

Leuchtmittelempfehlung: LED max. 3W/300lm/2.700K/dimmbar **Art. Nr. 8-205**
bulb recommendation: LED max. 3W/300lm/2.700K/dimmable **Item No. 8-205**



C (s.S 6-7/s.p. 6-7)

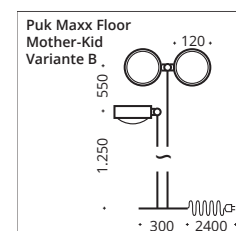
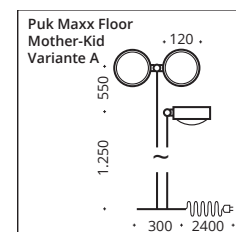

Chrom Teile/
chrome parts
 Gepulverte Teile/
powder-coating

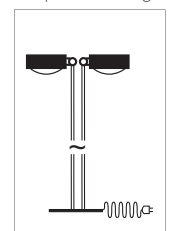

INDOOR





Sun Floor ø 90/130/210 Down Light

Der Leuchtenkopf der LED Stehleuchte Sun Floor, lässt sich in alle Richtungen über ein Kugelgelenk schwenken. Sie ist in den Durchmessern 90/130/210 mm erhältlich. Bei dieser Leseleuchte sind die Längen 1000 oder 1250 mm wählbar. Die Standardausstattung ist mit Schnurschalter und schwarzem Textilkabel. Optional kann die Leuchte mit Dimmring bestellt werden.

The luminaire head of the LED floor lamp Sun Floor can be swivelled in all directions via a ball joint. It is available in the diameters 90/130/210 mm. The lengths of 1000 and 1250 mm are available for this reading lamp. The standard version is with cord switch and black textile cable. Optionally, the luminaire can be ordered with a dimming ring.

INDOOR

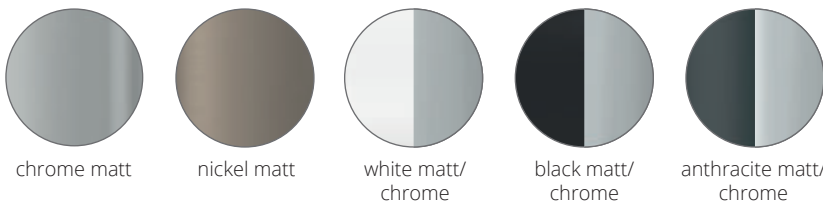

Sun Floor - Down Light LED

90 mm ø	130 mm ø	210 mm ø	Höhe height in mm	Gehäuse body
G 8 Watt, ~2.700k ~920 lm	G 12 Watt, ~2.700k ~1.300 lm	G 16 Watt, ~2.700k ~1.600 lm		
7-3329011	7-33213011	7-33221011	1.000	chrome matt
7-3329012	7-33213012	7-33221012	1.000	chrome
7-3329013	7-33213013	7-33221013	1.000	nickel matt
7-3329012-22	7-33213012-22	7-33221012-22	1.000	white matt/chrome
7-3329012-02	7-33213012-02	7-33221012-02	1.000	black matt/chrome
7-3329012-23	7-33213012-23	7-33221012-23	1.000	anthracite matt/chr.
Dimmring	Art.-Nr. item no.	-DR		chrome

Sun Floor - Down Light LED

90 mm ø	130 mm ø	210 mm ø	Höhe height in mm	Gehäuse body
G 8 Watt, ~2.700k ~920 lm	G 12 Watt, ~2.700k ~1.300 lm	G 16 Watt, ~2.700k ~1.600 lm		
7-3339011	7-33313011	7-33321011	1.250	chrome matt
7-3339012	7-33313012	7-33321012	1.250	chrome
7-3339013	7-33313013	7-33321013	1.250	nickel matt
7-3339012-22	7-33313012-22	7-33321012-22	1.250	white matt/chrome
7-3339012-02	7-33313012-02	7-33321012-02	1.250	black matt/chrome
7-3339012-23	7-33313012-23	7-33321012-23	1.250	anthracite matt/chr.
Dimmring	Art.-Nr. item no.	-DR		chrome

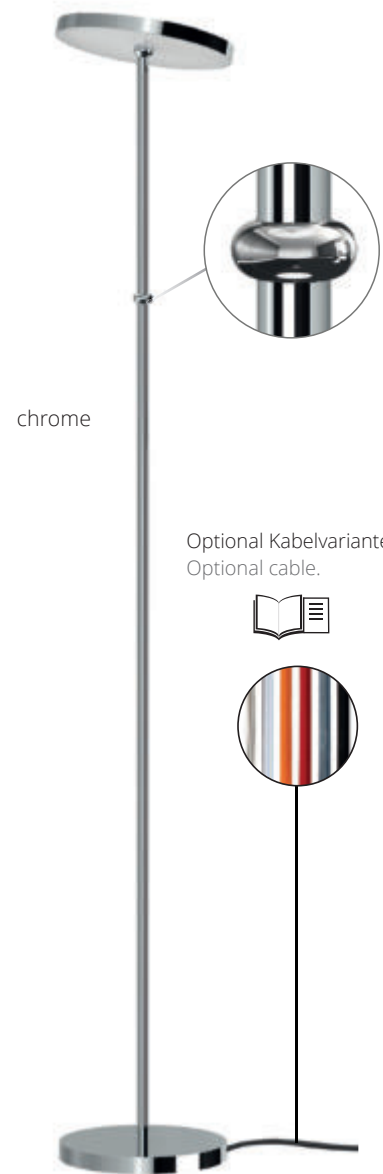

Optional Kabelvarianten.
Optional cable.



□ Chrom Teile/
chrome parts
■ Gepulverte Teile/
powder-coating

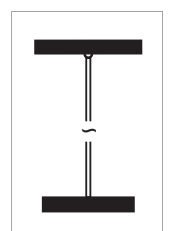
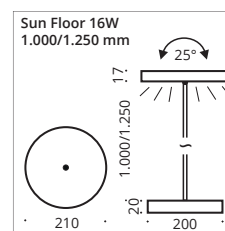
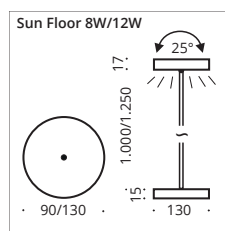
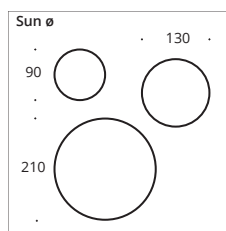



Sun Floor Uplight



Sun Floor \varnothing 90/130/210 Up or Down Light

Der Leuchtenkopf des LED Standfluters Sun Floor, lässt sich in alle Richtungen über ein Kugelgelenk schwenken. Diese Stehleuchte hat einen Leuchtenkopfdurchmesser von 210 mm und eine Länge von 1800 mm. Sie ist als Up- oder Downlight lieferbar. Die Standardausstattung ist mit Schnurschalter und schwarzem Textilkabel. Optional kann die Leuchte mit Dimmrig bestellt werden.

The luminaire head of the LED Sun Floor model can be swivelled in all directions via a ball joint. This floor lamp has a diameter of 210 mm and a length of 1800 mm. It is available as uplight or downlight. The standard version is with cord switch and black textile cable. Optionally, the luminaire can be ordered with a dimming ring.

INDOOR

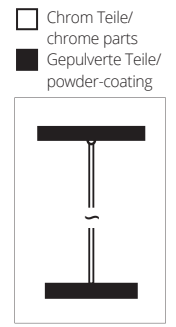
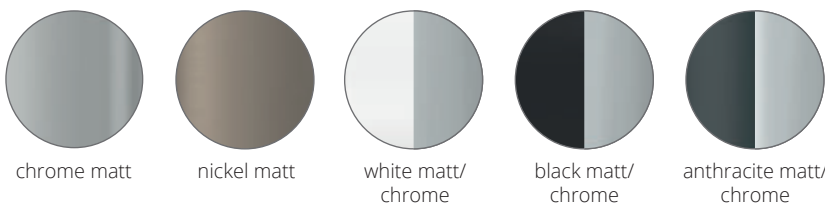

Optional Kabelvarianten.
Optional cable.



Sun Floor – Up or Down Light LED

Up Light 210 mm \varnothing G 16 Watt, ~2.700k ~1.600 lm	Down Light 210 mm \varnothing G 16 Watt, ~2.700k ~1.600 lm	Höhe height in mm	Gehäuse body
● 7-33421011	● 7-33521011	1.800	chrome matt
● 7-33421012	● 7-33521012	1.800	chrome
● 7-33421013	● 7-33521013	1.800	nickel matt
● 7-33421012-22	● 7-33521012-22	1.800	white matt/chrome
● 7-33421012-02	● 7-33521012-02	1.800	black matt/chrome
● 7-33421012-23	● 7-33521012-23	1.800	anthracite matt/chr.
Dimmring	Art.-Nr. item no.	-DR	chrome



C (s.S 6-7/s.p. 6-7)

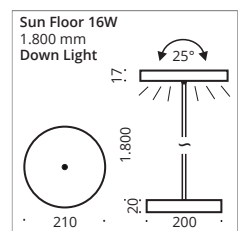
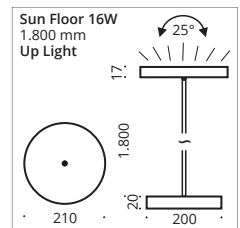
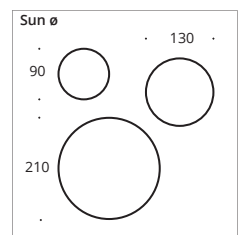
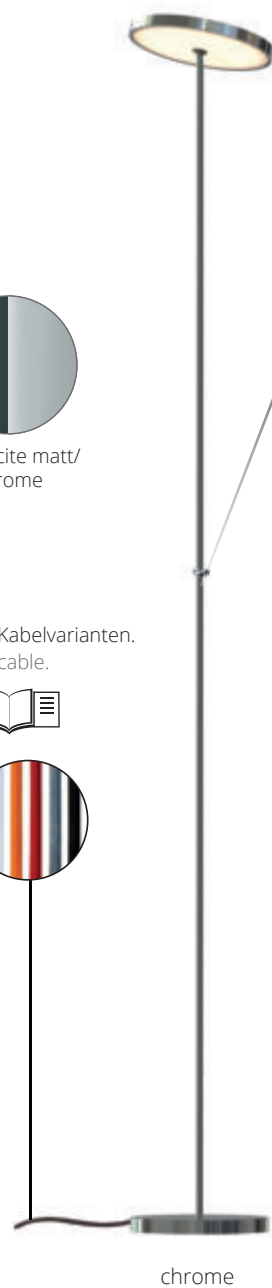



JAGANWATH STORIES
KARIN TIDBECK

Puk Maxx Eye Table

TISCHLEUCHTEN

TABLE LAMPS



Puk Mini Spot 269
Puk Maxx Spot 271



Puk Mini Eye Table 273
Puk Maxx Eye Table 275
Puk Meg Maxx Eye Table 277



Puk Mini Table 279
Puk Maxx Table 281



Puk Mini Flexlight Table 283



Sun Table 285



Light On 287



Flexlight Table 289





Puk Mini Spot \varnothing 80

LED oder Halogen Tischstrahler, der gezielt seinen Spot auf die wichtigen Dinge im Raum richtet. Mit Kabelschalter oder optional mit Schnur-Tast-Dimmer, um über 360° drehbar. Der Leuchtenkopf ist schwenkbar. Die Standardausstattung ist mit schwarzem Textilkabel.

LED or Halogen Table spotlight which directs its focus on the important things in the room. With cable switch or optionally with cord touch dimmer. Can be rotated by over 360°. Standard: black textile cable.

INDOOR

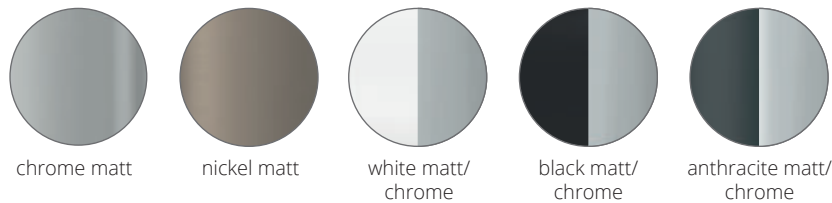

Puk Mini Spot LED G 8W, ~600lm ~2.700k	Puk Mini Spot G9 Fassung	Fuß \varnothing base \varnothing in mm	Gehäuse body
6-901401	6-901401-H	130	chrome matt
6-901402	6-901402-H	130	chrome
6-901403	6-901403-H	130	nickel matt
6-901402-22	6-901402-H-22	130	white matt/chr.
6-901402-02	6-901402-H-02	130	black matt/chr.
6-901402-23	6-901402-H-23	130	anthracite matt/chr.

-D Für Schnur-Dimmer »-D« an die Art.-Nr. hängen
Attach »-D« behind the item no. for a dimmer

- ▶ Ohne Zubehör. Bestell-Artikelnummern für Linse, Glas, Farbfilter und die Konfigurationsempfehlung auf der Einklappseite!
- ▶ Without accessories: Order item-no. for lens, glass, color filter and the recommended Configuration are on the fold-in page!

Leuchtmittelangabe: LED **G** inkl. | G9 max. 33W ECO, optional LED Retrofit
lamp information: LED **G** incl. | G9 max. 33W ECO, LED Retrofit optional

Leuchtmittelempfehlung: LED max. 3W/300lm/2.700K/dimmbar **G** Art Nr. 8-205
bulb recommendation: LED max. 3W/300Lm/2.700K/dimmable **G** Item No. 8-205



- Chrom Teile/
chrome parts
- Gepulverte Teile/
powder-coating

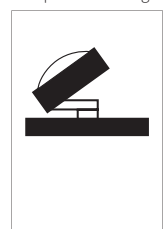
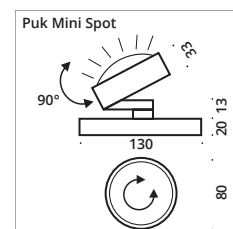





Puk Maxx Spot \varnothing 120

LED oder Halogen Tischstrahler, der gezielt seinen Spot auf die wichtigen Dinge im Raum richtet. Mit Kabelschalter oder optional mit Schnur-Tast-Dimmer, um über 360 Grad drehbar. Der Leuchtenkopf ist schwenkbar. Die Standardausstattung ist mit schwarzem Textilkabel.

LED or Halogen Table spotlight which directs its focus on the important things in the room. With cable switch or optionally with cord touch dimmer. Can be rotated by over 360°. Standard: black textile cable.

INDOOR

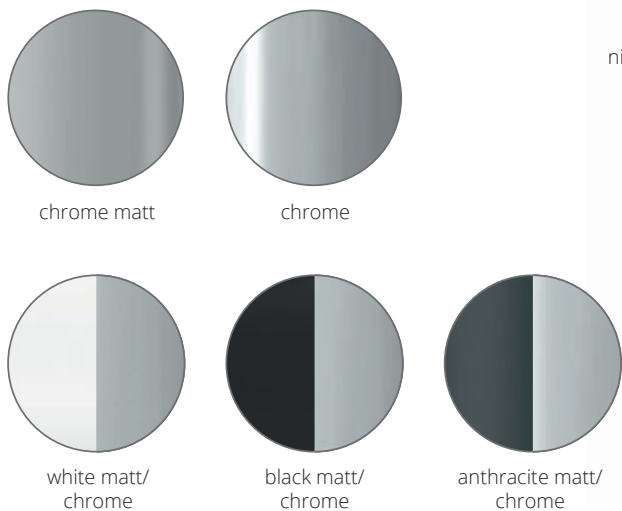

nickel matt

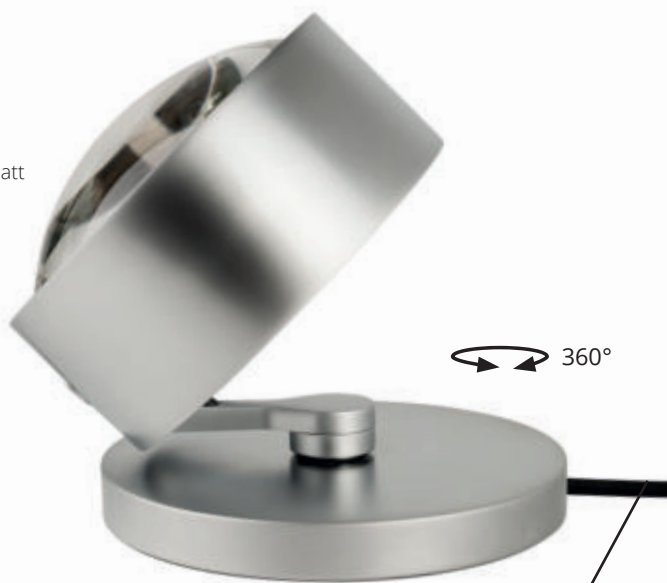

Optional Kabelvarianten.
Optional cable.



Puk Maxx Spot LED G 1 x 12W ~900lm ~2.700k	Puk Maxx Spot G9 Fassung	Fuß \varnothing base \varnothing in mm	Gehäuse body
	6-981401-H	130	chrome matt
	6-981402-H	130	chrome
	6-981403-H	130	nickel matt
	6-981402-H-22	130	white matt/chr.
	6-981402-H-02	130	black matt/chr.
	6-981402-H-23	130	anthracite matt/chr.

-D Für Schnur-Dimmer »-D« an die Art.-Nr. hängen
Attach »-D« behind the item no. for a dimmer

► Ohne Zubehör. Bestell-Artikelnummern für Linse, Glas, Farbfilter und die Konfigurationsempfehlung auf der Einklappseite!

► Without accessories: Order item-no. for lens, glass, color filter and the recommended Configuration are on the fold-in page!



Leuchtmittelangabe: LED **G** inkl. | G9 max. 33W ECO, optional LED Retrofit
bulb information: LED **G** incl. | G9 max. 33W ECO, LED Retrofit optional

Leuchtmittelempfehlung: LED max. 3W/300lm/2.700K/dimmbar **G** Art Nr. 8-205
bulb recommendation: LED max. 3W/300Lm/2.700K/dimmable **G** Item No. 8-205



Chrom Teile/
chrome parts
 Gepulverte Teile/
powder-coating

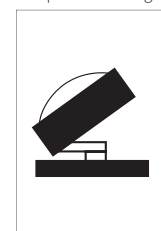
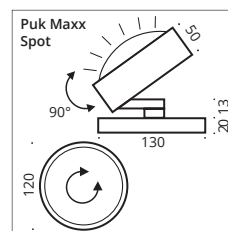



Puk Mini Eye Table



Puk Mini Eye Table ø 80

Tisch- oder Standleuchte, LED Niedervolt mit Tast-Dimmer oder G9 Fassung (mit Schnurschalter, Schnur-Dimmer optional). Die Standardausstattung ist mit schwarzem Textilkabel.

Table or floor lamp. LED low voltage with touch dimmer or G9 socket (with cord switch or cord dimmer, optional). Standard: black textile cable.

INDOOR

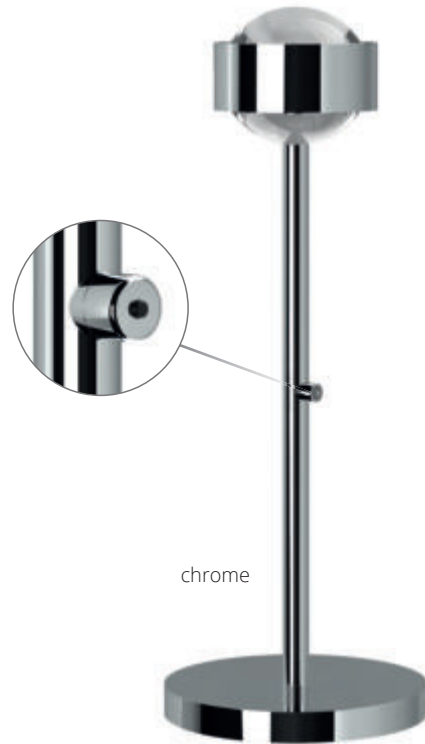
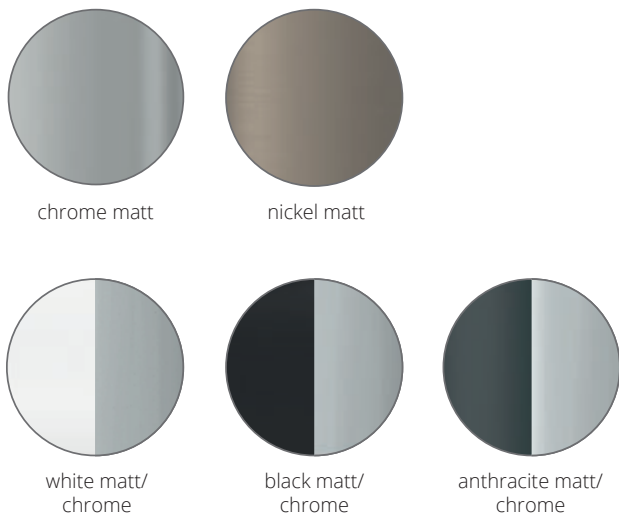

Puk Meg Maxx Eye G9 Fassung ON/OFF	Puk Mini Eye NV LED 20W ~2x900lm ~2.700k	Höhe height in mm	Gehäuse body
6-083701-G9	6-083701-NV-LED	370	chrome matt
6-083702-G9	6-083702-NV-LED	370	chrome
6-083703-G9	6-083703-NV-LED	370	nickel matt
6-083702-22-G9	6-083702-NV-LED-22	370	white matt/chr.
6-083702-02-G9	6-083702-NV-LED-02	370	black matt/chr.
6-083702-23-G9	6-083702-NV-LED-23	370	anthracite matt/chr.
6-084701-G9	6-084701-NV-LED	470	chrome matt
6-084702-G9	6-084702-NV-LED	470	chrome
6-084703-G9	6-084703-NV-LED	470	nickel matt
6-084702-22-G9	6-084702-NV-LED-22	470	white matt/chr.
6-084702-02-G9	6-084702-NV-LED-02	470	black matt/chr.
6-084702-23-G9	6-084702-NV-LED-23	470	anthracite matt/chr.

Für Schnur-Dimmer bei G9 Leuchte »-D« an die Art.-Nr. hängen (Hochvolt)
Attach »-D« behind the item no. for a G9 cable dimmer (high voltage)

Die LED Niedervolt Leuchten sind standardmäßig mit Tast-Dimmer ausgestattet
The LED low voltage luminaires are standard equipped with touch dimmer

- ▶ Ohne Zubehör. Bestell-Artikelnummern für Linse, Glas, Farbfilter und die Konfigurationsempfehlung auf der Einklappseite!
- ▶ Without accessories: Order item-no. for lens, glass, color filter and the recommended Configuration are on the fold-in page!



Leuchtmittelangabe: LED Retrofit **G inkl.** ~3Watt ~300lm ~2.700K | G9 max. 33W ECO
lamp information: LED Retrofit **G incl.** ~3Watt ~300lm ~2.700K | G9 max. 33W ECO

Leuchtmittelpfehlung: LED max. 3W/300lm/2.700K/dimmbar **G** Art Nr. 8-205
bulb recommendation: LED max. 3W/300Lm/2.700K/dimmable **G** Item No. 8-205

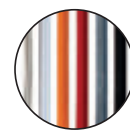

Optional Kabelvarianten.
Optional cable.



Eye Konfiguration (Empfehlung)
Eye Configuration (recommendation)

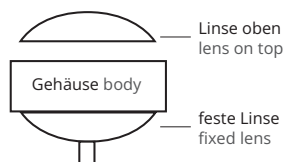

- Chrom Teile/
chrome parts
- Gepulverte Teile/
powder-coating

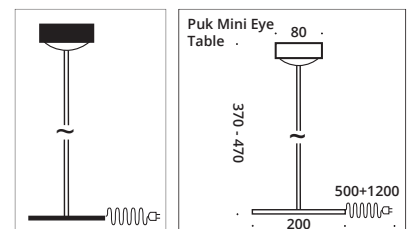

C (s.S 6-7/s.p. 6-7)



Puk Maxx Eye Table



Puk Maxx Eye Table ø 120

Tisch- oder Stehleuchte mit fester Linse, LED Niedervolt mit Tast-Dimmer oder G9 Fassung (mit Schnurschalter, Schnur-Dimmer optional). Die Standardausstattung ist mit schwarzem Textilkabel.

Table or floor lamp. LED low voltage with touch dimmer or G9 socket (with cord switch or cord dimmer, optional). Standard: black textile cable.

INDOOR

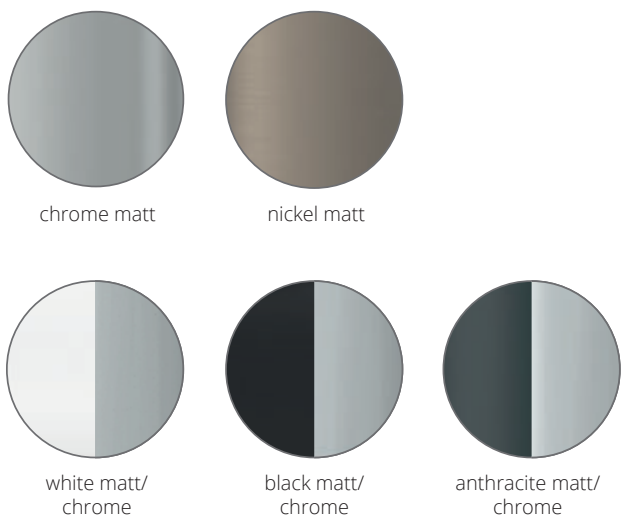

Puk Meg Maxx Eye G9 Fassung ON/OFF	Puk Maxx Eye NV LED 20W ~2x900lm ~2.700k	Höhe height in mm	Gehäuse body
6-383701-G9	6-383701-NV-LED	370	chrome matt
6-383702-G9	6-383702-NV-LED	370	chrome
6-383703-G9	6-383703-NV-LED	370	nickel matt
6-383702-22-G9	6-383702-NV-LED-22	370	white matt/chr.
6-383702-02-G9	6-383702-NV-LED-02	370	black matt/chr.
6-383702-23-G9	6-383702-NV-LED-23	370	anthracite matt/chr.
6-384701-G9	6-384701-NV-LED	470	chrome matt
6-384702-G9	6-384702-NV-LED	470	chrome
6-384703-G9	6-384703-NV-LED	470	nickel matt
6-384702-22-G9	6-384702-NV-LED-22	470	white matt/chr.
6-384702-02-G9	6-384702-NV-LED-02	470	black matt/chr.
6-384702-23-G9	6-384702-NV-LED-23	470	anthracite matt/chr.

Für Schnur-Dimmer bei G9 Leuchte »-D« an die Art.-Nr. hängen (Hochvolt)
Attach »-D« behind the item no. for a G9 cable dimmer (high voltage)

Die LED Niedervolt Leuchten sind standardmäßig mit Tast-Dimmer ausgestattet
The LED low voltage luminaires are standard equipped with touch dimmer

► Ohne Zubehör. Bestell-Artikelnummern für Linse, Glas, Farbfilter und die Konfigurationsempfehlung auf der Einklappseite!



► Without accessories: Order item-no. for lens, glass, color filter and the recommended Configuration are on the fold-in page!

Leuchtmittelangabe: LED Retrofit **G inkl.** ~3Watt ~300lm ~2.700K | G9 max. 33W ECO
lamp information: LED Retrofit **G incl.** ~3Watt ~300lm ~2.700K | G9 max. 33W ECO

Leuchtmittlempfehlung: LED max. 3W/300lm/2.700K/dimmbar **G** Art Nr. 8-205
bulb recommendation: LED max. 3W/300lm/2.700K/dimmable **G** Item No. 8-205



Optional Kabelvarianten.
Optional cable.



Eye Konfiguration (Empfehlung) Eye Configuration (recommendation)

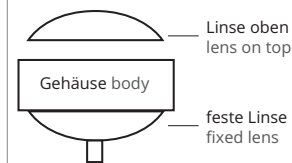

- Chrom Teile/
chrome parts
- Gepulverte Teile/
powder-coating

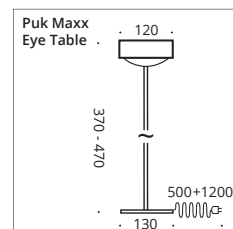
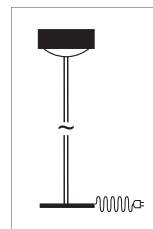



Puk Meg Maxx Eye Table



Puk Meg Maxx Eye Table ø 160

Tisch- oder Stehleuchte mit fester Linse, LED Niedervolt mit Tast-Dimmer oder G9 Fassung (mit Schnurschalter, Schnur-Dimmer optional). Die Standardausstattung ist mit schwarzem Textilkabel.

Table or floor lamp. LED low voltage with touch dimmer or G9 socket (with cord switch or cord dimmer, optional). Standard: black textile cable.

INDOOR

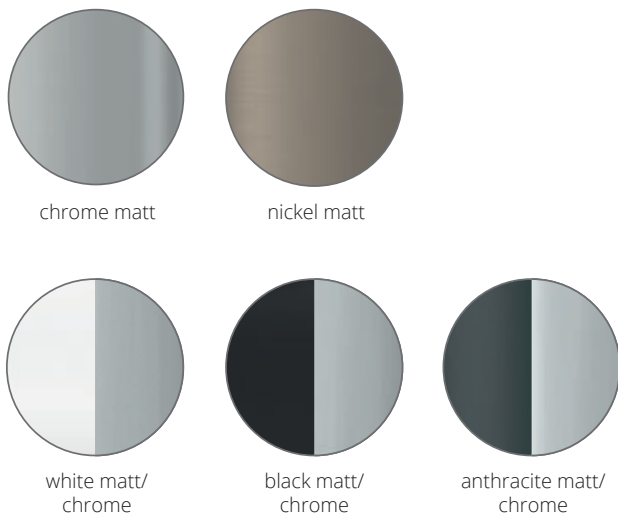

Puk Meg Maxx Eye G9 Fassung ON/OFF	Puk Meg Maxx Eye NV LED 20W ~2x900lm ~2.700k	Höhe height in mm	Gehäuse body
6-403701-G9	6-403701-NV-LED	370	chrome matt
6-403702-G9	6-403702-NV-LED	370	chrome
6-403703-G9	6-403703-NV-LED	370	nickel matt
6-403702-22-G9	6-403702-NV-LED-22	370	white matt/chr.
6-403702-02-G9	6-403702-NV-LED-02	370	black matt/chr.
6-403702-23-G9	6-403702-NV-LED-23	370	anthracite matt/chr.
6-404701-G9	6-404701-NV-LED	470	chrome matt
6-404702-G9	6-404702-NV-LED	470	chrome
6-404703-G9	6-404703-NV-LED	470	nickel matt
6-404702-22-G9	6-404702-NV-LED-22	470	white matt/chr.
6-404702-02-G9	6-404702-NV-LED-02	470	black matt/chr.
6-404702-23-G9	6-404702-NV-LED-23	470	anthracite matt/chr.

Für Schnur-Dimmer bei G9 Leuchte »-D« an die Art.-Nr. hängen (Hochvolt)
Attach »-D« behind the item no. for a G9 cable dimmer (high voltage)

Die LED Niedervolt Leuchten sind standardmäßig mit Tast-Dimmer ausgestattet
The LED low voltage luminaires are standard equipped with touch dimmer

- ▶ Ohne Zubehör. Bestell-Artikelnummern für Linse, Glas, Farbfilter und die Konfigurationsempfehlung auf der Einklappseite!
- ▶ Without accessories: Order item-no. for lens, glass, color filter and the recommended Configuration are on the fold-in page!



Leuchtmittelangabe: LED Retrofit **G inkl.** ~3Watt ~300lm ~2.700K | G9 max. 33W ECO
lamp information: LED Retrofit **G incl.** ~3Watt ~300lm ~2.700K | G9 max. 33W ECO

Leuchtmittlempfehlung: LED max. 3W/300lm/2.700K/dimmbar **G** Art Nr. 8-205
bulb recommendation: LED max. 3W/300Lm/2.700K/dimmable **G** Item No. 8-205



Optional Kabelvarianten.
Optional cable.



Eye Konfiguration (Empfehlung)
Eye Configuration (recommendation)

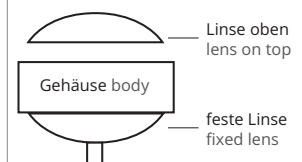

- Chrom Teile/
chrome parts
- Gepulverte Teile/
powder-coating

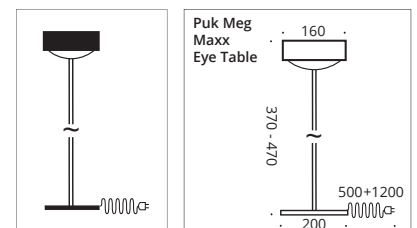



Puk Mini Table Single



Puk Mini Table \varnothing 80

Tischleuchte, LED Niedervolt mit Tast-Dimmer oder G9 Fassung (mit Schnurschalter, Schnur-Dimmer optional), Köpfe drehbar mit Verstellstift, Arm schwenkbar. Die Standardausstattung ist mit schwarzem Textilkabel.

Table lamp, LED low voltage with touch dimmer or G9 socket (with cord switch or cord dimmer, optional), heads rotatable with adjustment pin, arm swivelling. Standard: black textile cable.

INDOOR

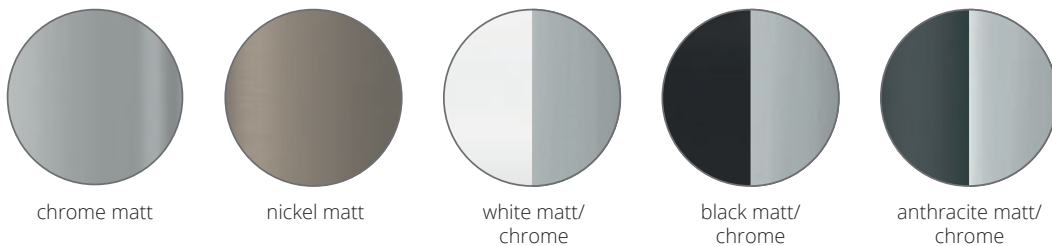

Puk Mini Table G9 Fassung ON/OFF	Puk Mini Table NV LED ~2.700k	Armlänge arm length in mm	Gehäuse body
Single	Single 20W, ~2x900lm		
6-08601-1-G9	6-08601-1-NV-LED	600	chrome matt
6-08602-1-G9	6-08602-1-NV-LED	600	chrome
6-08603-1-G9	6-08603-1-NV-LED	600	nickel matt
6-08602-1-22-G9	6-08602-1-NV-LED-22	600	white matt/chr.
6-08602-1-02-G9	6-08602-1-NV-LED-02	600	black matt/chr.
6-08602-1-23-G9	6-08602-1-NV-LED-23	600	anthracite matt/chr.
Single	Single 20W, ~2x900lm		
6-08801-1-G9	6-08801-1-NV-LED	800	chrome matt
6-08802-1-G9	6-08802-1-NV-LED	800	chrome
6-08803-1-G9	6-08803-1-NV-LED	800	nickel matt
6-08802-1-22-G9	6-08802-1-NV-LED-22	800	white matt/chr.
6-08802-1-02-G9	6-08802-1-NV-LED-02	800	black matt/chr.
6-08802-1-23-G9	6-08802-1-NV-LED-23	800	anthracite matt/chr.
Twin	Twin 20W, ~4x600lm		
6-08601-2-G9	6-08601-2-NV-LED	600	chrome matt
6-08602-2-G9	6-08602-2-NV-LED	600	chrome
6-08603-2-G9	6-08603-2-NV-LED	600	nickel matt
6-08602-2-22-G9	6-08602-2-NV-LED-22	600	white matt/chr.
6-08602-2-02-G9	6-08602-2-NV-LED-02	600	black matt/chr.
6-08602-2-23-G9	6-08602-2-NV-LED-23	600	anthracite matt/chr.
Twin	Twin 20W, ~4x600lm		
6-08801-2-G9	6-08801-2-NV-LED	800	chrome matt
6-08802-2-G9	6-08802-2-NV-LED	800	chrome
6-08803-2-G9	6-08803-2-NV-LED	800	nickel matt
6-08802-2-22-G9	6-08802-2-NV-LED-22	800	white matt/chr.
6-08802-2-02-G9	6-08802-2-NV-LED-02	800	black matt/chr.
6-08802-2-23-G9	6-08802-2-NV-LED-23	800	anthracite matt/chr.



chrome



Optional Kabelvarianten.
Optional cable.



Für Schnur-Dimmer bei G9 Leuchte »-D« an die Art.-Nr. hängen (Hochvolt)
Attach »-D« behind the item no. for a G9 cable dimmer (high voltage)

Die LED Niedervolt Leuchten sind standardmäßig mit Tast-Dimmer ausgestattet
The LED low voltage luminaires are standard equipped with touch dimmer

- ▶ Ohne Zubehör. Bestell-Artikelnummern für Linse, Glas, Farbfilter und die Konfigurationsempfehlung auf der Einklappseite!
- ▶ Without accessories: Order item-no. for lens, glass, color filter and the recommended Configuration are on the fold-in page!



Leuchtmittelangabe: LED Retrofit **G inkl.** ~3Watt ~300lm ~2.700K | G9 max. 33W ECO
lamp information: LED Retrofit **G incl.** ~3Watt ~300lm ~2.700K | G9 max. 33W ECO

Leuchtmittellempfehlung: LED max. 3W/300lm/2.700K/dimmbar **G** Art Nr. 8-205
bulb recommendation: LED max. 3W/300lm/2.700K/dimmable **G** Item No. 8-205

- Chrom Teile/
chrome parts
- Gepulverte Teile/
powder-coating

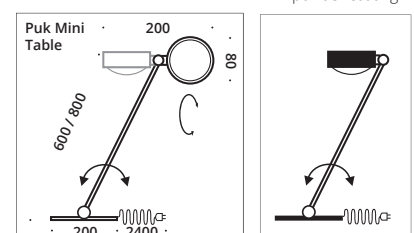





Puk Maxx Table ø 120

Tischleuchte mit einem Leuchtenkopf, LED Niedervolt mit Tast-Dimmer oder G9 Fassung (mit Schnurschalter, Schnur-Dimmer optional), Kopf drehbar, Arm schwenkbar. Die Standardausstattung ist mit schwarzem Textilkabel.

Table lamp, LED low voltage with touch dimmer or G9 socket (with cord switch or cord dimmer, optional), heads rotatable with adjustment pin, arm swivelling. Standard: black textile cable.

INDOOR

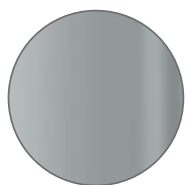

chrome matt



nickel matt

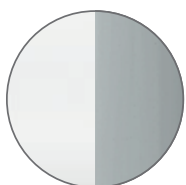

white matt/
chrome

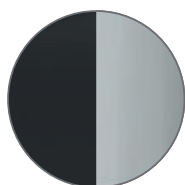

black matt/
chrome

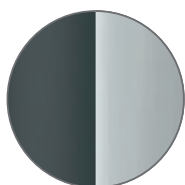

anthracite matt/
chrome



chrome

Puk Maxx Floor Mother-Kid G9 Fassung ON/OFF	Puk Maxx Table NV LED 20W ~2x900lm ~2.700k	Armlänge arm length in mm	Gehäuse body
6-38601-G9	6-38601-NV-LED	600	chrome matt
6-38602-G9	6-38602-NV-LED	600	chrome
6-38603-G9	6-38603-NV-LED	600	nickel matt
6-38602-22-G9	6-38602-NV-LED-22	600	white matt/chr.
6-38602-02-G9	6-38602-NV-LED-02	600	black matt/chr.
6-38602-23-G9	6-38602-NV-LED-23	600	anthracite matt/chr.
6-38801-G9	6-38801-NV-LED	800	chrome matt
6-38802-G9	6-38802-NV-LED	800	chrome
6-38803-G9	6-38803-NV-LED	800	nickel matt
6-38802-22-G9	6-38802-NV-LED-22	800	white matt/chr.
6-38802-02-G9	6-38802-NV-LED-02	800	black matt/chr.
6-38802-23-G9	6-38802-NV-LED-23	800	anthracite matt/chr.

Für Schnur-Dimmer bei G9 Leuchte »-D« an die Art.-Nr. hängen (Hochvolt)
Attach »-D« behind the item no. for a G9 cable dimmer (high voltage)

Die LED Niedervolt Leuchten sind standardmäßig mit Tast-Dimmer ausgestattet
The LED low voltage luminaires are standard equipped with touch dimmer

▶ Ohne Zubehör. Bestell-Artikelnummern für Linse, Glas, Farbfilter und die Konfigurationsempfehlung auf der Einklappseite!



▶ Without accessories: Order item-no. for lens, glass, color filter and the recommended Configuration are on the fold-in page!

Leuchtmittelangabe: LED Retrofit **G inkl.** ~3Watt ~300lm ~2.700K | G9 max. 33W ECO
lamp information: LED Retrofit **G incl.** ~3Watt ~300lm ~2.700K | G9 max. 33W ECO

Leuchtmittelpfehlung: LED max. 3W/300lm/2.700K/dimmbar **G** Art Nr. 8-205
bulb recommendation: LED max. 3W/300Lm/2.700K/dimmable **G** Item No. 8-205



Optional Kabelvarianten.
Optional cable.



- Chrom Teile/
chrome parts
- Gepulverte Teile/
powder-coating

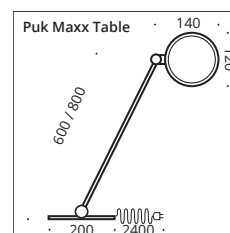
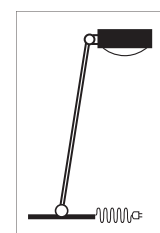



Puk Flexlight Table



Puk Mini Flexlight Table \varnothing 80

Kombinieren Sie den Puk-Kopf, Halogen oder LED, mit Flexarm und Ihrer Wunschbasis, Gläser/Linsen und Farbfilter werden separat dazubestellt. Die Standardausstattung ist mit Schnurschalter und schwarzem Textilkabel.

Combine the Puk head, Halogen or LED, with flex arm and your desired base. Glasses/lenses and colour filters are sold separately. Standard: black textile cable.

INDOOR

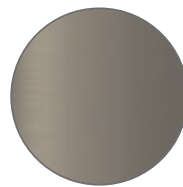

nickel matt



chrome

Puk Flexlight Table LED G 2 x 8W, ~1.200lm, ~2.700k	Puk Flexlight Table G9 Fassung	Armlänge arm length in mm	Gehäuse body
3-7020114-LED	3-7020114	200	chrome
3-7020214-LED	3-7020214	200	nickel matt
3-7030114-LED	3-7030114	300	chrome
3-7030214-LED	3-7030214	300	nickel matt

Für Schnur-Dimmer »-D« an die Art.-Nr. hängen (Hochvolt)
Attach »-D« behind the item no. for a cable dimmer (high voltage)

- ▶ Ohne Zubehör. Bestell-Artikelnummern für Linse, Glas, Farbfilter und die Konfigurationsempfehlung auf der Einklappseite!
- ▶ Without accessories: Order item-no. for lens, glass, color filter and the recommended Configuration are on the fold-in page!



G9 max. 33W, optional LED Retrofit
 G9 max. 33W, LED Retrofit optional

Leuchtmittelempfehlung: LED max. 3W/300lm/2.700K/dimmbar **G** Art Nr. 8-205
 bulb recommendation: LED max. 3W/300Lm/2.700K/dimmable **G** Item No. 8-205

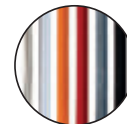

Optional Kabelvarianten.
Optional cable.

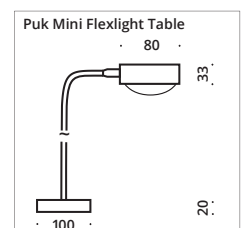

C (s.S 6-7/s.p. 6-7)



Sun Table



Sun Table ø 90/130/210

Der Leuchtenkopf der LED Tischleuchte Sun Table, lässt sich in alle Richtungen über ein Kugelgelenk schwenken. Sie ist in den Durchmessern 90/130/210 mm als Downlight erhältlich. Als Nachttisch-, Fensterbank-, Küchen- oder Schreibtischleuchte findet sie ihren individuellen Einsatz. Die Standardausstattung ist mit Schnurschalter und schwarzem Textilkabel. Optional kann ein Dimmring bestellt werden.

The lamp head of the Sun Table LED table lamp can be swivelled in all directions via a ball joint. It is available in the diameters 90/130/210 mm as downlight. Whether it is used as a bedside, windowsill, kitchen or desk light The standard equipment is with cord switch and black textile cable. A dimming ring can be ordered as an option.

INDOOR

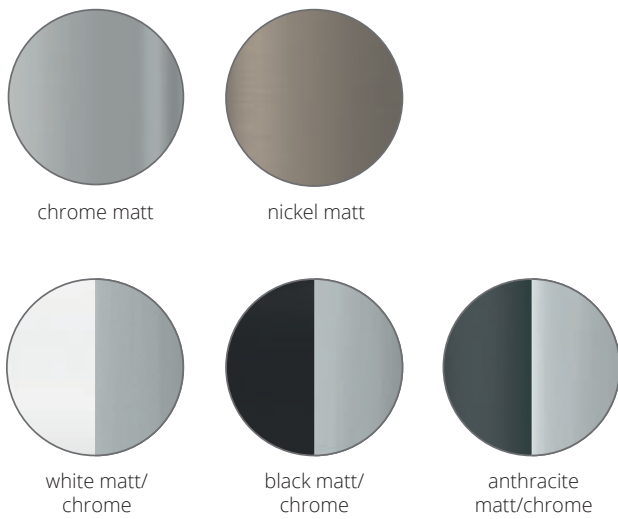

Sun Table LED - ø 90 mm

H 232 mm 90 mm ø G 8 Watt, ~2.700k ~920 lm	H 332 mm 90 mm ø G 8 Watt, ~2.700k ~920 lm	Gehäuse body
7-3299011	7-3309011	chrome matt
7-3299012	7-3309012	chrome
7-3299013	7-3309013	nickel matt
7-3299012-22	7-3309012-22	white matt/chr.
7-3299012-02	7-3309012-02	black matt/chr.
7-3299012-23	7-3309012-23	anthracite matt/chr.
Dimmring	Art.-Nr. item no. -DR	chrome

Sun Table LED - ø 130 mm

H 232 mm 130 mm ø G 12 Watt, ~2.700k ~1.300 lm	H 332 mm 130 mm ø G 12 Watt, ~2.700k ~1.300 lm	Gehäuse body
7-32913011	7-33013011	chrome matt
7-32913012	7-33013012	chrome
7-32913013	7-33013013	nickel matt
7-32913012-22	7-33013012-22	white matt/chr.
7-32913012-02	7-33013012-02	black matt/chr.
7-32913012-23	7-33013012-23	anthracite matt/chr.
Dimmring	Art.-Nr. item no. -DR	chrome

Sun Table LED - ø 210 mm

H 332 mm 210 mm ø G 16 Watt, ~2.700k ~1.600 lm	H 432 mm 210 mm ø G 16 Watt, ~2.700k ~1.600 lm	Gehäuse body
7-33021011	7-33121011	chrome matt
7-33021012	7-33121012	chrome
7-33021013	7-33121013	nickel matt
7-33021012-22	7-33121012-22	white matt/chr.
7-33021012-02	7-33121012-02	black matt/chr.
7-33021012-23	7-33121012-23	anthracite matt/chr.
Dimmring	Art.-Nr. item no. -DR	chrome

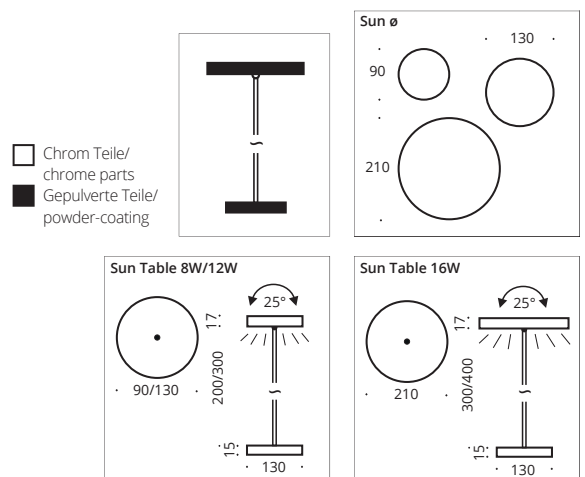





Light On

Schwere Tisch- und Bücherleuchte in Schwarz matt oder Weiß matt, wahlweise mit Puk-Kopf, Pisa-Glas oder Silkschirm. Integrierter Dimmer, mit schwarzem Textilkabel, Schalter und Stecker, Filzboden, Gewicht 4,5 kg.

Heavy table lamp and book light in black matt or white matt. Optional with Puk head, Pisa glass or Silk shade. Integrated dimmer, black textile cable, switch and plug, felt - covered base, weight 4.5 KG.

INDOOR



Puk black matt & white matt



Pisa black matt & white matt



Silk black matt

Kopf Puk Fassung G9	Kopf Pisa Fassung G9	Kopf Silk Fassung E14	Gehäuse body
6-24060344 6-24070304	6-24060343 6-24070303	6-24060347 6-24070305	black matt white matt

Weitere Schirm-Farben für die Silk finden Sie auf der Einklappseite. You can find more colors for the silk shades on the fold in page.



Optional Kabelvarianten. Optional cable.



180° Reflektor optional für Glas Pisa, Art.-Nr. 9-204. 180° Baffle optional for glass Pisa, item number 9-204.

G9 max. 33W ECO, optional LED Retrofit	Leuchtmittlempfehlung: LED max. 3W/300lm/2.700K/dimmbar	Art Nr. 8-205
	bulb recommendation: LED max. 3W/300Lm/2.700K/dimmable	Item No. 8-205
E14 max. 20W, optional LED Retrofit	Leuchtmittlempfehlung: LED max. 6W/470lm/2.700K	Art. Nr. 8-524
	bulb recommendation: LED max. 6W/470Lm/2.700K	Item No. 8-524



Reflektor "Option":
Aluminium-Hochleistungsreflektor, einfache Montage durch Einschub in den Glastubus.

Baffle "option":
High performance aluminium baffle, easy installation: slides into the glass tube.

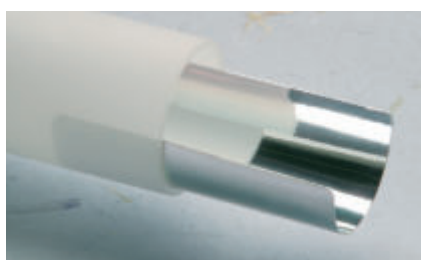

C (s.S 6-7/s.p. 6-7)

Light-on



Flexlight Table Pisa/Silk



Flexlight Table

Individuelle Kopfauswahl auf flexiblem Leuchtenarm und solidem Standfuß. Die Standardausstattung ist mit Schnur- schalter und schwarzem Textilkabel.

Individual luminaire head selection on flexible luminaire arm and solid base. Standard equipment: with cord switch and black textile cable.

INDOOR



Iglo

India

Pisa

Silk

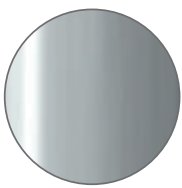

chrome



nickel matt



Optional Kabelvarianten.
Optional cable.



Rio

Iglo Table	India Table	Pisa Table	Silk Table	Rio Table	Armlänge arm length in mm	Gehäuse body
G9 ohne Leuchtmittel without lamp	G9 ohne Leuchtmittel without lamp	G9 ohne Leuchtmittel without lamp	E14 ohne Leuchtmittel without lamp	GU10 ohne Leuchtmittel without lamp		
3-7020101	3-7020102	3-7020103	3-7020105	3-7020117	200	chrome
3-7020201	3-7020202	3-7020203	3-7020205	3-7020217	200	nickel matt
3-7030101	3-7030102	3-7030103	3-7030105	3-7030117	300	chrome
3-7030201	3-7030202	3-7030203	3-7030205	3-7030217	300	nickel matt
3-7040101	3-7040102	3-7040103	3-7040105	3-7040117	400	chrome
3-7040201	3-7040202	3-7040203	3-7040205	3-7040217	400	nickel matt

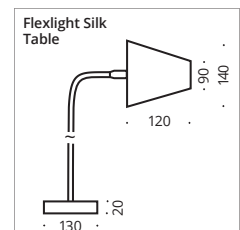

CE LED C IP20 C (s.S 6-7/s.p. 6-7)

<p>G9 max. 33W ECO, optional LED Retrofit G9 max. 33W ECO, LED Retrofit optional</p>	<p>Leuchtmittlempfehlung: LED max. 3W/300lm/2.700K/dimmbar G bulb recommendation: LED max. 3W/300Lm/2.700K/dimmable G</p>	<p>Art. Nr. 8-205 Item No. 8-205</p>
<p>E14 max. 20W, optional LED Retrofit E14 max. 20W, LED Retrofit optional</p>	<p>Leuchtmittlempfehlung: LED max. 6W/470lm/2.700K G bulb recommendation: LED max. 6W/470Lm/2.700K G</p>	<p>Art. Nr. 8-524 Item No. 8-524</p>
<p>GU10 max. 35W, optional LED Retrofit GU10 max. 35W, LED Retrofit optional</p>	<p>Leuchtmittlempfehlung: LED max. 4W/230lm/2.700K G bulb recommendation: LED max. 4W/230Lm/2.700K G</p>	<p>Art. Nr. 8-211 Item No. 8-211</p>

180° Reflektor optional für Glas Pisa, 180° baffle optional for glass Pisa Art.-Nr. 9-204

"Touch me" Dimmer, "Touch me" dimmer Art.-Nr. -D

Weitere Schirm-Farben für die Silk finden Sie auf der Einklappseite. You can find more colors for the silk shades on the fold in page.

SYSTEM

- | | |
|--------------------------------------|-----------|
| 1. Mini Track | 294 - 307 |
| 2. Top Line: Ceiling, Gallery, Crown | 308 - 341 |
| 3. Eutrac | 342 - 347 |

Perfekt zugeschnitten auf jede Art der Illumination sind unsere Leuchtensysteme. Auch anspruchsvolle architektonische Bereiche lassen sich optimal ausleuchten. Dabei kann jeder nach Lust und Laune seinen Geschmack ausleben. Auch lange Flure oder schwierige Ecken lassen sich mit den Schienensystemen leicht überbrücken. Modernste LED Technologie hält dabei die Kosten in Grenzen. Wahlweise sind aber auch Modelle mit Halogenfassung erhältlich.

Our luminaire systems are perfectly tailored to every type of illumination. Even challenging architectural areas can be optimally illuminated. Everyone can live out his or her taste according to desire and taste.. Even long corridors or difficult corners can be easily illuminated with the track systems. State-of-the-art LED technology keeps costs within limits. Models with halogen sockets are also available.

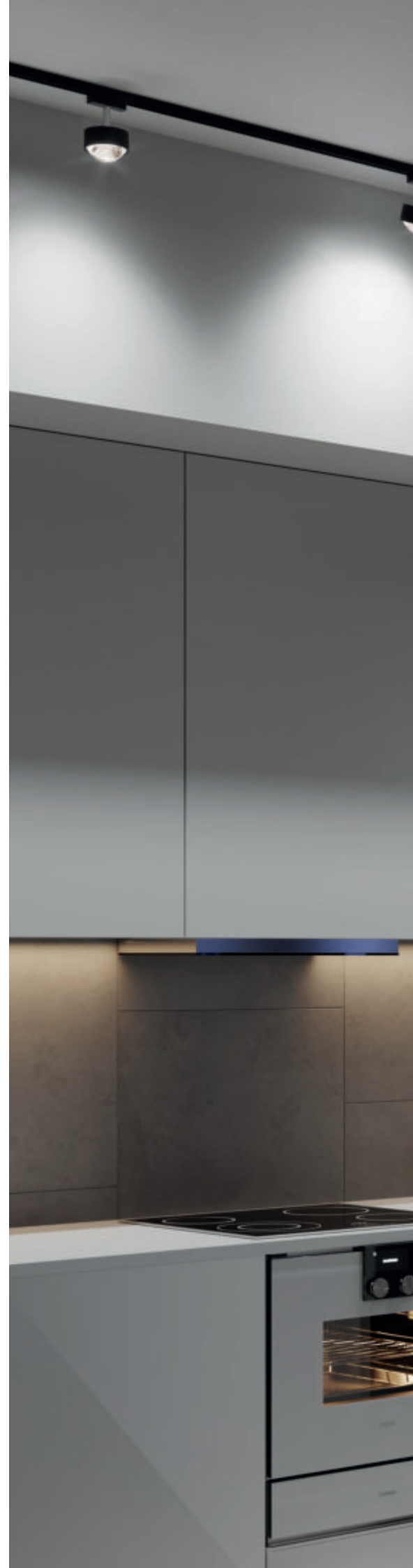





SYSTEMLEUCHTEN SYSTEM LAMPS

1. Mini Track 292 - 307



Puk Mini Turn 299



Puk Mini Eye 299



Puk Mini Side Single 199
Puk Mini Side Twin 301



Puk Mini Long One 301
Puk Maxx Long One 301



Puk Mini Drop 302
Puk Maxx Drop 302



Puk Mini Flex 302



Look at me 303



Pela (Quadro) 303



Sun Ceiling 304



Sun Swing 304/305



Glaslight 305/306
Spotlight 306



Neo 307

2. Top Line 308 - 341



Top Line Ceiling
310 - 319



Top Line Gallery
324 - 329



Top Line Crown
330 - 329



Sun Swing 321



Pela (Quadro) 322



Look at me 323

3. Eutrac 342 - 347



Puk Mini Turn 343
Puk Maxx Turn 345



Puk Mini Eye 343
Puk Maxx Eye 345



Puk Mini Side 343
Puk Maxx Side 345



Puk Mini Flex 343



Puk Maxx Next 345



Puk Mini Long One 343
Puk Maxx Long One 345



Puk Mini Drop 343
Puk Maxx Drop 345



Allround 347

MINI TRACK Components Overview



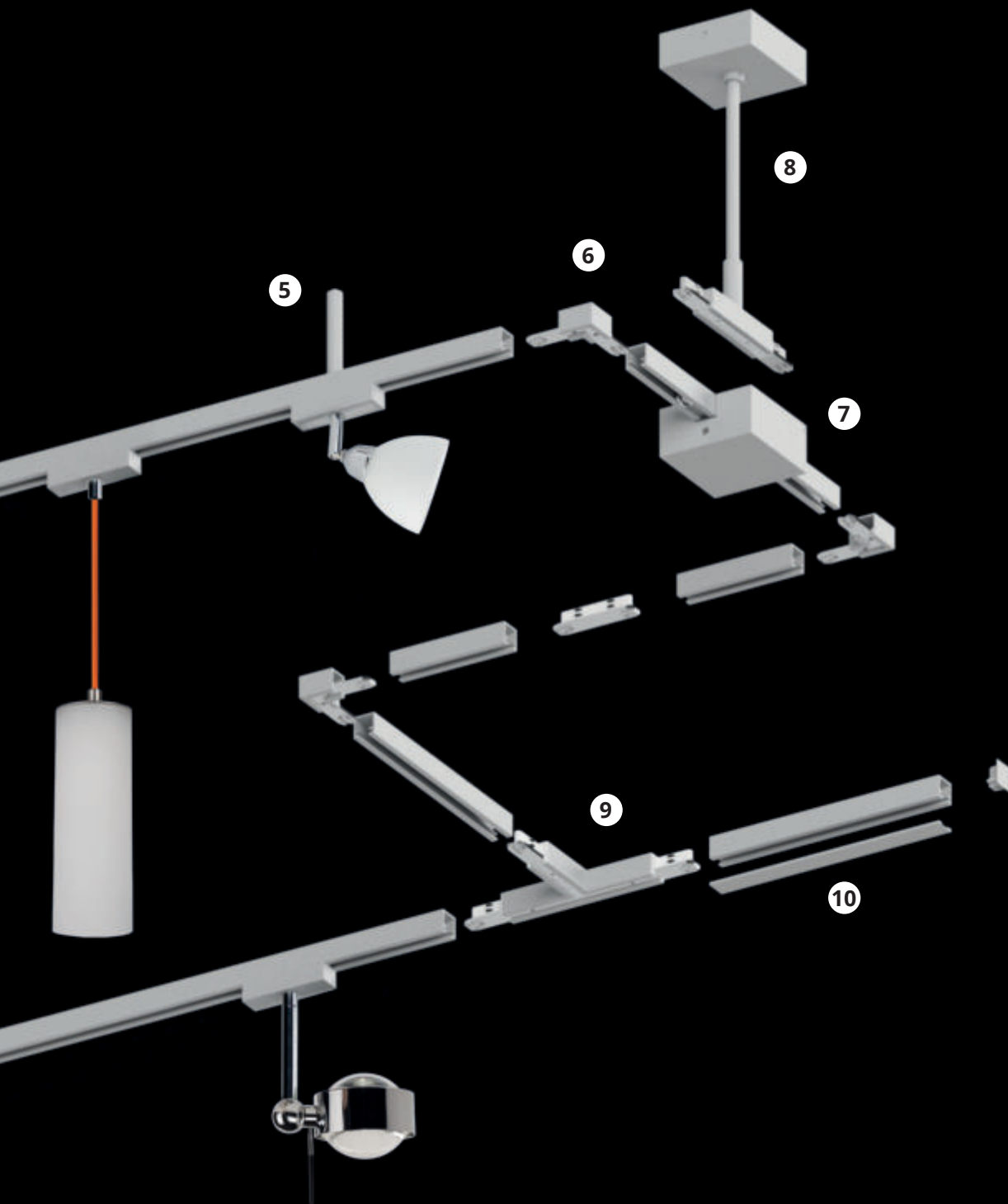

- ① Endkappe / End piece
- ② Profil besonders klein 18 x 18 mm / Profile very small 18 x 18 mm
- ③ Seilabhängung / Steel cable suspension
- ④ Linearverbinder / Linear junction
- ⑤ Deckenbefestigung / Surface mounting
- ⑥ 90° Winkelverbinder / T-Connection
- ⑦ Mitteleinspeisung mit Baldachin / Centre power feed with canopy
- ⑧ Kabelmitteleinspeisung mit Baldachin / Centre cable power feed with canopy
- ⑨ T-Verbinder / T-Connection
- ⑩ Blindabdeckung / Aluminium cover
- ⑪ Endeinspeisung / End power feed
- ⑫ Kabelendeinspeisung mit Baldachin / Cable end power feed with canopy



Art Nr	Farbe	Beschreibung Mini Track	L mm	B mm	H mm
33-102-cr	chrom	2 Phasen Schiene	1000	18	18
33-102-w	weiß	2 Phasen Schiene	1000	18	18
33-102-b	schwarz	2 Phasen Schiene	1000	18	18
33-102-s	natur eloxiert	2 Phasen Schiene	1000	18	18
33-103-cr	chrom	2 Phasen Schiene	2000	18	18
33-103-w	weiß	2 Phasen Schiene	2000	18	18
33-103-b	schwarz	2 Phasen Schiene	2000	18	18
33-103-s	natur eloxiert	2 Phasen Schiene	2000	18	18
33-104-w	weiß	2 Phasen Schiene	2950	18	18
33-104-b	schwarz	2 Phasen Schiene	2950	18	18
33-104-s	natur eloxiert	2 Phasen Schiene	2950	18	18

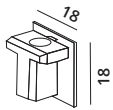

33-105-s	natur eloxiert-silber	Endkappe Schiene	18	18	18
33-105-w	weiß	Endkappe Schiene	18	18	18
33-105-b	schwarz	Endkappe Schiene	18	18	18

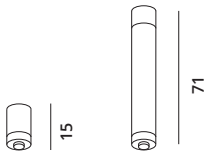

33-106-cr	chrom	Deckenbefestigung	12	12	15
33-106-w	weiß	Deckenbefestigung	12	12	15
33-106-b	schwarz	Deckenbefestigung	12	12	15
33-106-s	natur eloxiert	Deckenbefestigung	12	12	15
33-107-cr	chrom	Deckenbefestigung	12	12	71
33-107-w	weiß	Deckenbefestigung	12	12	71
33-107-b	schwarz	Deckenbefestigung	12	12	71
33-107-s	natur eloxiert	Deckenbefestigung	12	12	71

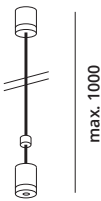

33-108-cr	chrom	Seilabhängung	13	13	1000
33-108-w	weiß	Seilabhängung	13	13	1000
33-108-b	schwarz	Seilabhängung	13	13	1000
33-108-s	natur eloxiert	Seilabhängung	13	13	1000

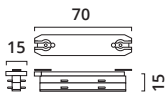

33-109-cr	chrom	Linearverbinder	70	15	15
-----------	-------	-----------------	----	----	----

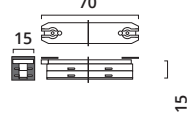

33-110-cr	chrom	Isolierverbinder	70	15	15
-----------	-------	------------------	----	----	----

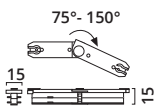

33-111-cr	chrom	Flex-Verbinder 75-150°	110	15	15
-----------	-------	------------------------	-----	----	----

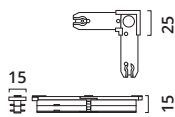

33-112-cr	chrom	Winkelverbinder 90°	25	15	15
33-112-w	weiß	Winkelverbinder 90°	25	15	15
33-112-b	schwarz	Winkelverbinder 90°	25	15	15
33-112-s	natur eloxiert	Winkelverbinder 90°	25	15	15

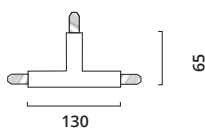

33-113-cr	chrom	T-Verbinder	130	65	18
33-113-w	weiß	T-Verbinder	130	65	18
33-113-b	schwarz	T-Verbinder	130	65	18
33-113-s	natur eloxiert	T-Verbinder	130	65	18

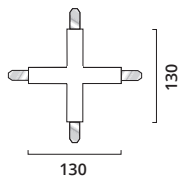

33-114-cr	chrom	Kreuzverbinder	130	130	18
33-114-w	weiß	Kreuzverbinder	130	130	18
33-114-b	schwarz	Kreuzverbinder	130	130	18
33-114-s	natur eloxiert	Kreuzverbinder	130	130	18

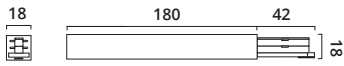

TL Art Nr	Farbe	Beschreibung MINI TRACK	L mm	B mm	H mm
33-115-cr	chrom	Endeinspeisung	180	18	18
33-115-w	weiß	Endeinspeisung	180	18	18
33-115-b	schwarz	Endeinspeisung	180	18	18
33-115-s	natur eloxiert	Endeinspeisung	180	18	18

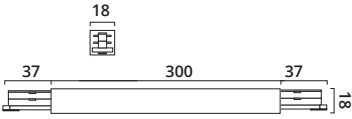

33-116-cr	chrom	Mitteinspeisung	300	18	18
33-116-w	weiß	Mitteinspeisung	300	18	18
33-116-b	schwarz	Mitteinspeisung	300	18	18
33-116-s	natur eloxiert	Mitteinspeisung	300	18	18

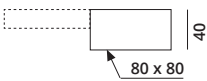

33-117-cr	chrom	Endeinspeisung Baldachin	80	80	40
33-117-w	weiß	Endeinspeisung Baldachin	80	80	40
33-117-b	schwarz	Endeinspeisung Baldachin	80	80	40
33-117-s	natur eloxiert	Endeinspeisung Baldachin	80	80	40

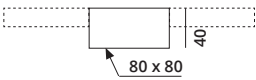

33-118-cr	chrom	Mitteinspeisung Baldachin	80	80	40
33-118-w	weiß	Mitteinspeisung Baldachin	80	80	40
33-118-b	schwarz	Mitteinspeisung Baldachin	80	80	40
33-118-s	natur eloxiert	Mitteinspeisung Baldachin	80	80	40

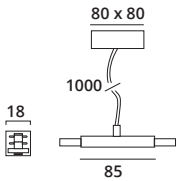

33-119-cr	chrom	Kabelmitteleinspeisung	80	80	1000
33-119-w	weiß	Kabelmitteleinspeisung	80	80	1000
33-119-b	schwarz	Kabelmitteleinspeisung	80	80	1000
33-119-s	natur eloxiert	Kabelmitteleinspeisung	80	80	1000

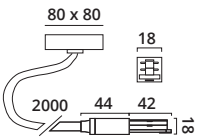

33-120-cr	chrom	Kabelendeinsp. Baldachin	80	80	2000
33-120-w	weiß	Kabelendeinsp. Baldachin	80	80	2000
33-120-b	schwarz	Kabelendeinsp. Baldachin	80	80	2000
33-120-s	natur eloxiert	Kabelendeinsp. Baldachin	80	80	2000

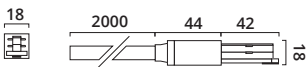

33-121-cr	chrom	Kabelendeinsp.o.Baldachin	18	18	2000
33-121-w	weiß	Kabelendeinsp.o.Baldachin	18	18	2000
33-121-b	schwarz	Kabelendeinsp.o.Baldachin	18	18	2000
33-121-s	natur eloxiert	Kabelendeinsp.o.Baldachin	18	18	2000



33-122-cr	chrom	Adapter für Hängeleuchten	71	18	34
33-122-s	natur eloxiert-silber	Adapter für Hängeleuchten	71	18	34
33-122-w	weiß	Adapter für Hängeleuchten	71	18	34
33-122-b	schwarz	Adapter für Hängeleuchten	71	18	34

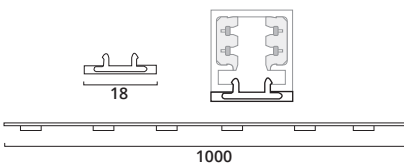

33-123-cr	chrom	Blindabdeckung	1000	18	3
33-123-w	weiß	Blindabdeckung	1000	18	3
33-123-b	schwarz	Blindabdeckung	1000	18	3
33-123-s	natur eloxiert	Blindabdeckung	1000	18	3





PUK TURN
DOWNLIGHT



PUK EYE CEILING
UP & DOWNLIGHT



PUK SIDE SINGLE
UP & DOWNLIGHT

Adapterfarben: für chrommatt = silber, für chrom = chrom, für weiß/chrom = weiß und für schwarz/chrom = schwarz
Adapter Color: for chrom matt = silver, for chrome = chrome, for white/chrome = white and for black/chrome = black



Fest installierte obere Linse.
Permanently installed lens.

SYSTEM

- Chrom Teile/
chrome parts
- Gepulverte Teile/
powdered parts

Puk Turn

LED **G**

Lumen: ~600

Kelvin: ~2.700

Watt: 1 x 8W

: Ø 80mm X H 97mm

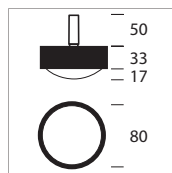

- Chrom Teile/
chrome parts
- Gepulverte Teile/
powdered parts

Puk Eye Ceiling

LED **G**

Lumen: ~1.200

Kelvin: ~2.700

Watt: 2 x 8W

: Ø 80mm X H 170mm

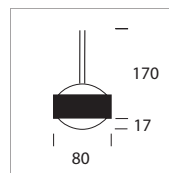

- Chrom Teile/
chrome parts
- Gepulverte Teile/
powdered parts

Puk Side Single

LED **G**

Lumen: ~1.200

Kelvin: ~2.700

Watt: 2 x 8W

: Ø 80mm X H 177mm

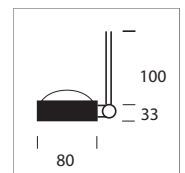

Farbe Color	Art.-Nr. Item-No.
chrome matt	2-38001-LED-MT-C
chrome	2-38002-LED-MT-D
white/chrome	2-3800-22-LED-MT-A
black/chrome	2-3800-02-LED-MT-B

Farbe Color	Art.-Nr. Item-No.
chrome matt	7-75001-MT-C
chrome	7-75002-MT-D
white/chrome	7-7500-22-MT-A
black/chrome	7-7500-02-MT-B

Farbe Color	Art.-Nr. Item-No.
chrome matt	2-0821-LED-MT-C
chrome	2-0822-LED-MT-D
white/chrome	2-082-22-LED-MT-A
black/chrome	2-082-02-LED-MT-B

Bei den Puk Leuchten werden zu dem Leuchtenkopf die Gläser/Linsen und optional die Farbfilter separat dazubestellt. Artikelnummern entnehmen Sie bitte der Equipment-Tabelle auf der Einklappseite.

With the Puk lamps, the glasses, lenses and optional the color filters are ordered separately. Please check the equipment list on the fold-in page for item numbers.



Mini Track Puk Turn & Puk Long One



PUK SIDE TWIN
UP & DOWNLIGHT



PUK LONG ONE
DOWNLIGHT



PUK MAXX LONG ONE
DOWNLIGHT

Adapterfarben: für chrommatt = silber, für chrom = chrom, für weiß/chrom = weiß und für schwarz/chrom = schwarz
Adapter Color: for chrom matt = silver, for chrome = chrome, for white/chrome = white and for black/chrome = black

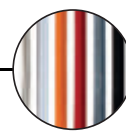

Optional Kabelvarianten.
Optional cable.



- Chrom Teile/
chrome parts
- Gepulverte Teile/
powdered parts

Puk Side Twin

LED **G**

Lumen: ~2.400

Kelvin: ~2.700

Watt: 4 x 8W

: Ø 80mm X H 177mm

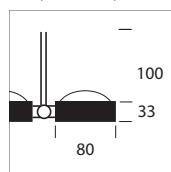

- Chrom Teile/
chrome parts
- Gepulverte Teile/
powdered parts

Puk Long One

LED **G**

Lumen: ~600

Kelvin: ~2.700

Watt: 1 x 8W

: Ø 80mm X H ~1.300mm

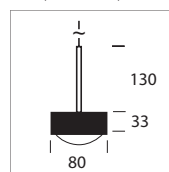

- Chrom Teile/
chrome parts
- Gepulverte Teile/
powdered parts

Puk Maxx Long One

LED **G**

Lumen: ~900

Kelvin: ~2.700

Watt: 1 x 12W

: Ø 120mm X H ~1.300mm

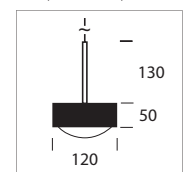

Farbe Color	Art.-Nr. Item-No.
chrome matt	2-0841-LED-MT-C
chrome	2-0842-LED-MT-D
white/chrome	2-084-22-LED-MT-A
black/chrome	2-084-02-LED-MT-B

Farbe Color	Art.-Nr. Item-No.
chrome matt	5-08001-1-LED-MT-C
chrome	5-08002-1-LED-MT-D
white/chrome	5-0800-22-1-LED-MT-A
black/chrome	5-0800-02-1-LED-MT-B

Farbe Color	Art.-Nr. Item-No.
chrome matt	5-38001-MT-C
chrome	5-38002-MT-D
white/chrome	5-3800-22-MT-A
black/chrome	5-3800-02-MT-B

Bei den Puk Leuchten werden zu dem Leuchtenkopf die Gläser/Linsen und optional die Farbfilter separat dazubestellt. Artikelnummern entnehmen Sie bitte der Equipment-Tabelle auf der Einklappseite.

With the Puk lamps, the glasses, lenses and optional the color filters are ordered separately. Please check the equipment list on the fold-in page for item numbers.



PUK DROP
UP & DOWNLIGHT



PUK MAXX DROP
UP & DOWNLIGHT



PUK FLEXLIGHT
UP & DOWNLIGHT

Adapterfarben: für chrommatt = silber, für chrom = chrom, für weiß/chrom = weiß und für schwarz/chrom = schwarz
Adapter Color: for chrom matt = silver, for chrome = chrome, for white/chrome = white and for black/chrome = black



□ Chrom Teile/
chrome parts
■ Gepulverte Teile/
powdered parts

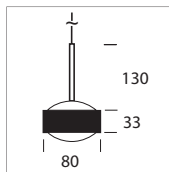

Puk Drop

LED **G**

Lumen: ~1.200

Kelvin: ~2.700

Watt: 2 x 8W

📏 : Ø 80mm X H ~1.300mm

□ Chrom Teile/
chrome parts
■ Gepulverte Teile/
powdered parts

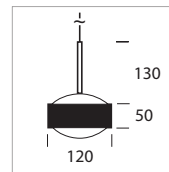

Puk Maxx Drop

LED **G**

Lumen: ~1.800

Kelvin: ~2.700

Watt: 2 x 12W

📏 : Ø 120mm X H ~1.300mm

□ Chrom Teile/
chrome parts
■ Gepulverte Teile/
powdered parts

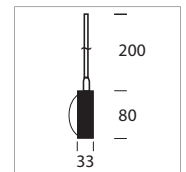

Puk Flexlight

LED **G**

Lumen: ~1.200

Kelvin: ~2.700

Watt: 2 x 8W

📏 : Ø 80mm X H 294mm

Farbe Color	Art.-Nr. Item-No.
chrome matt	5-06001-MT-C
chrome	5-06002-MT-D
white/chrome	5-0600-22-MT-A
black/chrome	5-0600-02-MT-B

Farbe Color	Art.-Nr. Item-No.
chrome matt	5-36001-MT-C
chrome	5-36002-MT-D
white/chrome	5-3600-22-MT-A
black/chrome	5-3600-02-MT-B

Farbe Color	Art.-Nr. Item-No.
chrome	20114-LED-MT-D

Bei den Puk Leuchten werden zu dem Leuchtenkopf die Gläser/Linsen und optional die Farbfilter separat dazubestellt. Artikelnummern entnehmen Sie bitte der Equipment-Tabelle auf der Einklappseite.

With the Puk lamps, the glasses, lenses and optional the color filters are ordered separately. Please check the equipment list on the fold-in page for item numbers.



LOOK AT ME
DOWNLIGHT



PELA
ALL-ROUND LIGHT



PELA QUADRO
ALL-ROUND LIGHT

Adapterfarben: für chrommatt = silber, für chrom = chrom, für weiß = weiß und für schwarz = schwarz
 Adapter Color: for chrom matt = silver, for chrome = chrome, for white = white and for black = black

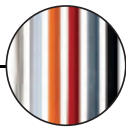

Optional Kabelvarianten.
Optional cable.

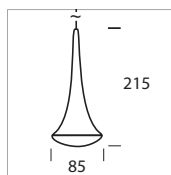

Look at me

LED **G**
 Lumen: ~600
 Kelvin: ~2.700
 Watt: 1 x 8W
 : Ø 85mm X H ~1.300mm

Farbe Color	Art.-Nr. Item-No.
chrome matt	5-911-1-MT-C
chrome	5-911-2-MT-D
white matt	5-911-22-MT-A
black matt	5-911-02-MT-B
lens clear	2-9126
lens frosted	2-9126-S

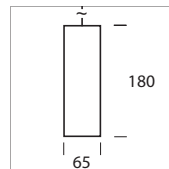

Pela

E27: ohne Leuchtmittel/without bulb
 Lumen: leuchtmittelabhängig
according to bulb
 Kelvin: leuchtmittelabhängig
according to bulb
 Watt: max. 1 x 42W optional LED Retrofit
 : Ø 65mm X H ~1.300mm

Farbe Color	Art.-Nr. Item-No.
chrome	5-07651-MT-D

Pela Quadro

E27: ohne Leuchtmittel/without bulb
 Lumen: leuchtmittelabhängig
according to bulb
 Kelvin: leuchtmittelabhängig
according to bulb
 Watt: max. 1 x 42W optional LED Retrofit
 : B 65mm X H ~1.300mm

Farbe Color	Art.-Nr. Item-No.
chrome	5-08651-MT-D

SYSTEM



SUN CEILING
DOWNLIGHT



SUN CEILING
DOWNLIGHT



SUN SWING
DOWNLIGHT

Adapterfarben: für chrommatt = silber, für chrom = chrom, für weiß/chrom = weiß und für schwarz/chrom = schwarz
Adapter Color: for chrom matt = silver, for chrome = chrome, for white/chrome = white and for black/chrome = black



□ Chrom Teile/
chrome parts
■ Gepulverte Teile/
powdered parts

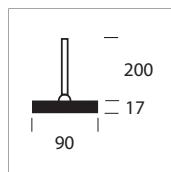

Sun Ceiling

LED **G**

Lumen: ~920

Kelvin: ~2.700

Watt: 1 x 8W

Ø 90mm X H 231mm



□ Chrom Teile/
chrome parts
■ Gepulverte Teile/
powdered parts

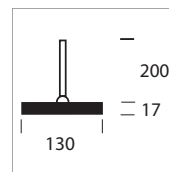

Sun Ceiling

LED **G**

Lumen: ~1.300

Kelvin: ~2.700

Watt: 1 x 12W

Ø 130mm X H 231mm

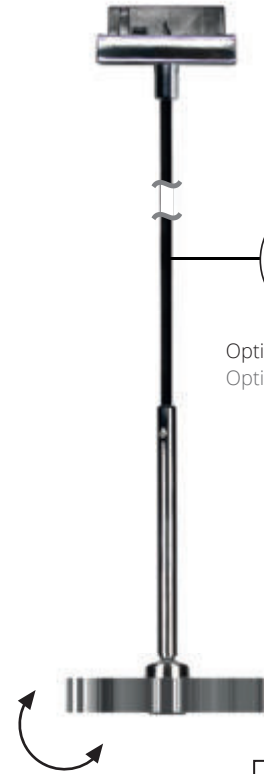

Optional Kabelvarianten.
Optional cable.



□ Chrom Teile/
chrome parts
■ Gepulverte Teile/
powdered parts

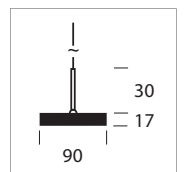

Sun Swing

LED **G**

Lumen: ~920

Kelvin: ~2.700

Watt: 1 x 8W

Ø 90mm X H ~1.300mm

Farbe Color	Art.-Nr. Item-No.
chrome matt	7-3269011-MT-C
chrome	7-3269012-MT-D
white/chrome	7-32690122-MT-A
black/chrome	7-32690102-MT-B

Farbe Color	Art.-Nr. Item-No.
chrome matt	7-32613011-MT-C
chrome	7-32613012-MT-D
white/chrome	7-326130122-MT-A
black/chrome	7-326130102-MT-B

Farbe Color	Art.-Nr. Item-No.
chrome matt	7-3289011-MT-C
chrome	7-3289012-MT-D
white/chrome	7-32890122-MT-A
black/chrome	7-32890102-MT-B



☑
SUN SWING
DOWNLIGHT

☑
IGLO
ALL-ROUND LIGHT

☑
INDIA
ALL-ROUND LIGHT

Adapterfarben: für chrommatt = silber, für chrom = chrom, für weiß/chrom = weiß und für schwarz/chrom = schwarz
Adapter Color: for chrom matt = silver, for chrome = chrome, for white/chrome = white and for black/chrome = black



☐ Chrom Teile/
chrome parts
■ Gepulverte Teile/
powdered parts

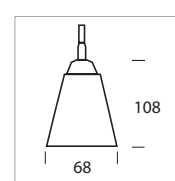
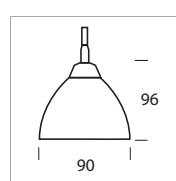
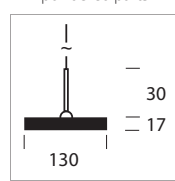

Sun Swing

LED **G**

Lumen: ~1.300

Kelvin: ~2.700

Watt: 1 x 12W

: Ø 130mm X H ~1.300mm

Iglo

G9: ohne Leuchtmittel/without bulb

Lumen: leuchtmittelabhängig
according to bulb

Kelvin: leuchtmittelabhängig
according to bulb

Watt: max. 1 x 33W

: Ø 90mm X H 160mm

India

G9: ohne Leuchtmittel/without bulb

Lumen: leuchtmittelabhängig
according to bulb

Kelvin: leuchtmittelabhängig
according to bulb

Watt: max. 1 x 33W

: Ø 68mm X H 172mm

Farbe Color	Art.-Nr. Item-No.
chrome matt	7-32813011-MT-C
chrome	7-32813012-MT-D
white/chrome	7-3281301-22-MT-A
black/chrome	7-3281301-02-MT-B

Farbe Color	Art.-Nr. Item-No.
chrome	0101-MT-D

Farbe Color	Art.-Nr. Item-No.
chrome	0102-MT-D

SYSTEM



PISA
ALL-ROUND LIGHT



Pisa

G9: ohne Leuchtmittel/without bulb
Lumen: leuchtmittelabhängig/according to bulb
Kelvin: leuchtmittelabhängig/according to bulb
Watt: max. 1 x 33W
📏 : Ø 38mm X H 162mm

Farbe Color	Art.-Nr. Item-No.
chrome	0103-MT-D



PISA DOUBLE
ALL-ROUND LIGHT

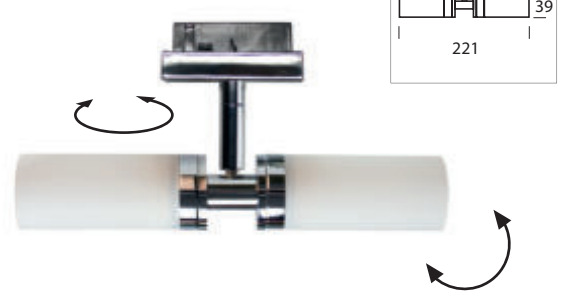

Pisa Double

G9: ohne Leuchtmittel/without bulb
Lumen: leuchtmittelabhängig/according to bulb
Kelvin: leuchtmittelabhängig/according to bulb
Watt: max. 2 x 33W
📏 : Ø 38mm X B 200mm x H 64mm

Farbe Color	Art.-Nr. Item-No.
chrome	0130-MT-D



BULB
ALL-ROUND LIGHT



Bulb

G9: ohne Leuchtmittel/without bulb
Lumen: leuchtmittelabhängig/according to bulb
Kelvin: leuchtmittelabhängig/according to bulb
Watt: max. 1 x 33W
📏 : Ø 80mm X H 154mm

Farbe Color	Art.-Nr. Item-No.
chrome	0132-MT-D



RIO
DOWNLIGHT



Rio

GU10: ohne Leuchtmittel/without bulb
Lumen: leuchtmittelabhängig/according to bulb
Kelvin: leuchtmittelabhängig/according to bulb
Watt: max. 1 x 4W LED Retrofit
📏 : Ø 65mm X H 144mm

Farbe Color	Art.-Nr. Item-No.
chrome	0117-MT-D



NEO TRACK
DOWNLIGHT



NEO SWING
DOWNLIGHT



NEO FLEX
DOWNLIGHT

Adapterfarbe: für aluminium = chrom und schwarz
Adapter Color: for aluminium = chrome and black

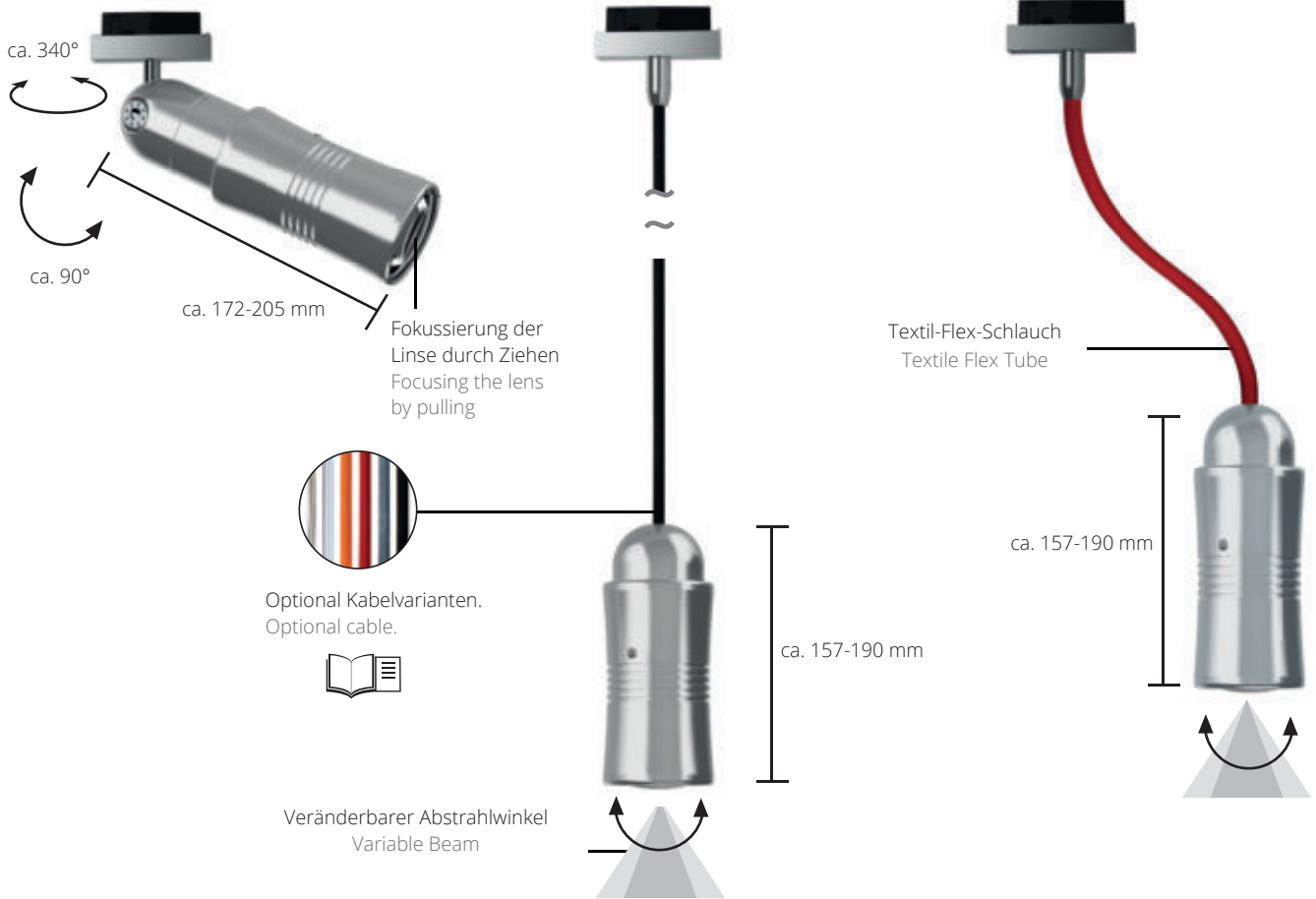

Optional Kabelvarianten.
Optional cable.



Veränderbarer Abstrahlwinkel
Variable Beam



Neo Track

LED **G**
Lumen: ~710
Kelvin: ~2.700
Watt: 1 x 10W
: Ø 65mm X L 172-205mm

Neo Pendant

LED **G**
Lumen: ~710
Kelvin: ~2.700
Watt: 1 x 10W
: Ø 65mm X H ~1.300mm

Neo Flex

LED **G**
Lumen: ~710
Kelvin: ~2.700
Watt: 1 x 10W
: Ø 65mm X H min. 511mm

Farbe Color	Art.-Nr. Item-No.
aluminium	16-02-MT-D

Farbe Color	Art.-Nr. Item-No.
aluminium	16-05-MT-D

Flexarm L	Art.-Nr. Item-No.
300mm red	16-06303-MT-D
300mm black	16-06306-MT-D
300mm grey	16-0630X-MT-D

SYSTEM









Top Line Components Overview

Standardmodelle auf Seite 202-215.

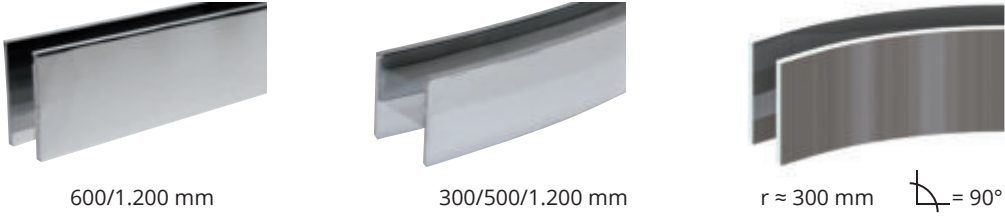
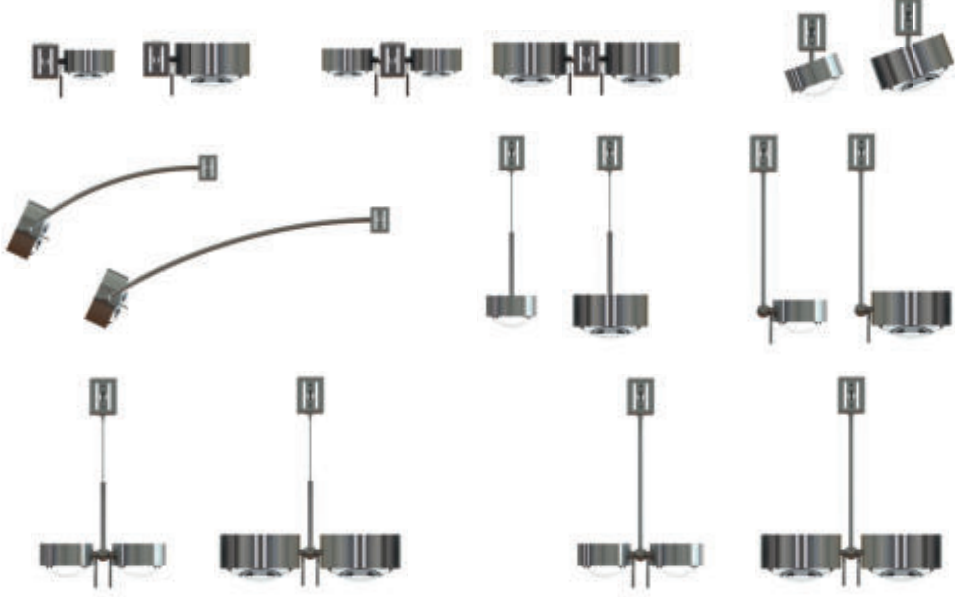
Standard models on page xx.

Abhängung suspension	
Verbinder/Halter/ Endstück connector/holder/ endpiece	
Schienen rails	 <p>600/1.200 mm 300/500/1.200 mm $r \approx 300 \text{ mm}$ $\alpha = 90^\circ$</p>
Köpfe/ Pendel Puk heads/ pendula Puk	
Pendel pendula	

SYSTEM





Top Line System Ceiling

Das Deckenleuchtensystem bietet optimale Flexibilität. Mit dem Doppelschienensystem können beliebige Winkel und Längen abgehängt und mit der gewünschten Anzahl an Leuchten bestückt werden. Egal ob Rohr- oder Seilabhängung, LED Power oder Halogen, das Puk System kreiert ein harmonisches Licht für jeden Bedarf. Hier nur einige Konfigurationsbeispiele.

Our Puk System Ceiling offers an optimum of flexibility. The double rail system can be suspended in every angle and length and equipped with an arbitrary number of lamps. Whether tube or wire suspension, LED or Halogen illumination, the Puk System creates harmoniously illumination. Here are just a few configuration examples.

Beispiele Systemführung & Konfiguration

Rail system & configuration examples

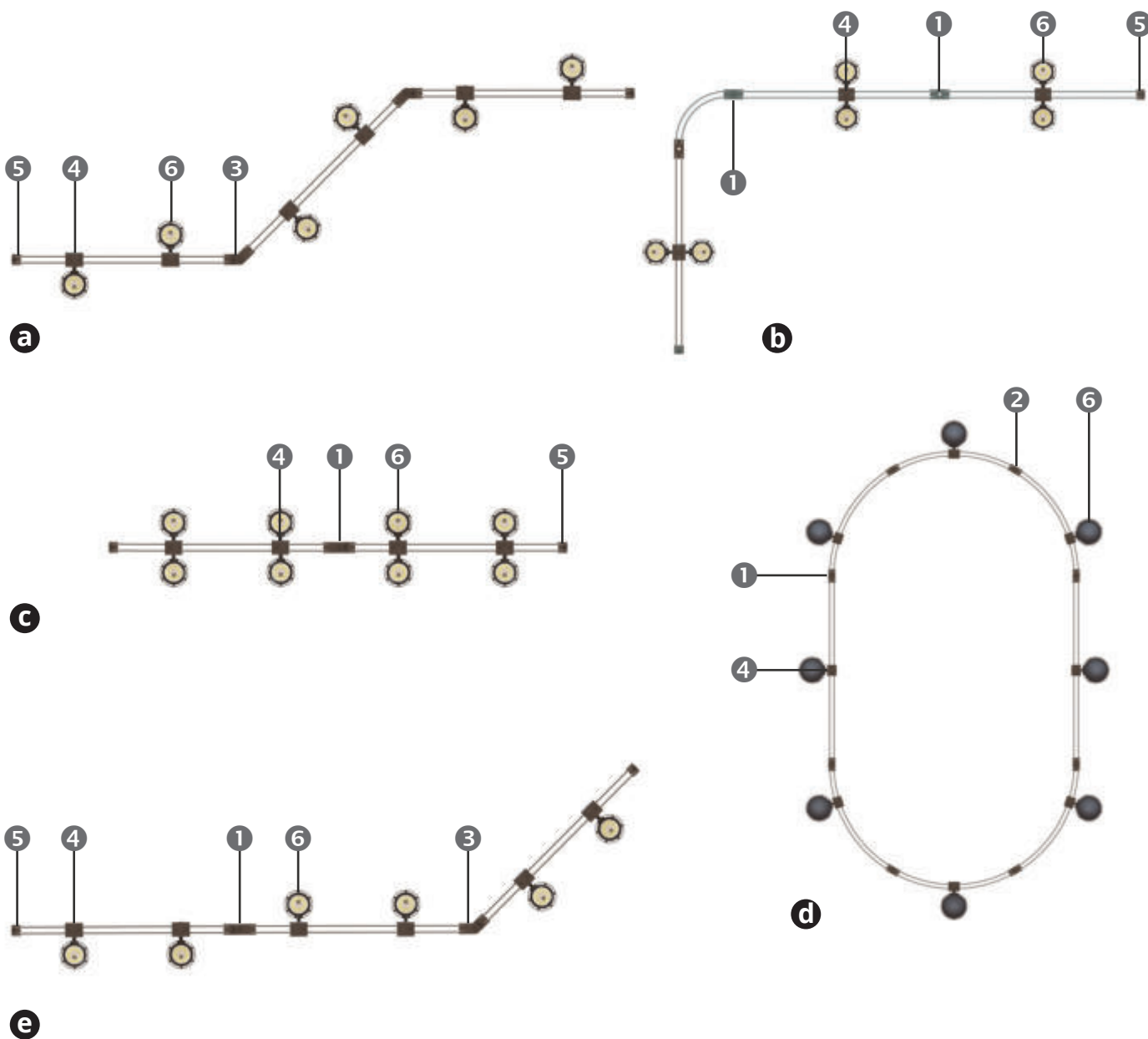

SYSTEM

Bei den Puk Leuchten werden zu dem Leuchtenkopf die Gläser/Linsen und optional die Farbfilter separat dazubestellt! Artikelnummern entnehmen Sie bitte den Equipment-Tabellen auf der Einklappseite.

With the Puk lamps, the glasses, lenses and optional the color filters are ordered separately. Please check the equipment lists on the fold-in page for item numbers.









Konfigurationsmöglichkeiten Configuration Options

Systemabhängungen & Schienenkomponenten System suspensions & rail components

	Seilabhängung wire suspension L=2.000 mm 	Einspeisung mit Seilabhängung feed in incl. wire suspension L=2.000 mm 	Rohrabhängung tube suspension L=100/150/ 200 mm 	Systemeinspeisung* feed-in* 
1 Verbinder gerade straight connector 	✓	✓	✓	nur Einspeisung, keine Abhängung only feed-in, no suspension
2 Verbinder gebogen bent connector 	✓	✓	✓	nur Einspeisung, keine Abhängung only feed-in, no suspension
3 Gelenkverbinder articulated connector 	✓	✓	✓	nur Einspeisung, keine Abhängung only feed-in, no suspension
4 Halter für Kopfmontage mounting support for heads 	✓	✓	✓	nur Einspeisung, keine Abhängung only feed-in, no suspension
5 Schienenendstück railendpiece 	✓	✓	✓	nur Einspeisung, keine Abhängung only feed-in, no suspension
6 Köpfe/Pendel heads/pendula 	✓	✓	✓	nur Einspeisung, keine Abhängung only feed-in, no suspension

SYSTEM

Regulär wird empfohlen, an den Verbindern/Endstücken abzuhängen. Aus optischen oder technischen Gründen kann aber auch auf andere Möglichkeiten, wie die Tabelle zeigt, zurückgegriffen werden. Preise der einzelnen Komponenten des Puk Systems entnehmen Sie bitte der Preisliste.

*beliebige Anbringung der Einspeisung am System

We recommend to hang up the system on the connectors or end pieces. For optical or technical reasons the above listed possibilities can be taken in consideration as well. Prices for parts and components of the PUK System are provided in the Pricelist.

*arbitrary feed-in mounting on the system

Top Line Ceiling components

Standardmodelle auf Seite 218 - 223.

Standard models on page 218 - 223.

SCHIENEN (kürzbar**) / RAILS (can be shortened**) 

Schiene gerade
rail straight

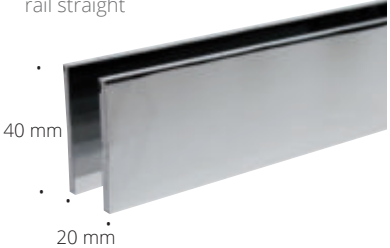

40 mm
20 mm

Doppelschiene Alu/double rail 

Maße/dimensions: B 20 x H 40 mm

Farbe/color	L (mm)	Art.-Nr. item-no.
chrome matt	600	8-070601
chrome	600	8-070602
nickel matt	600	8-070603
chrome matt	1.200	8-0701201
chrome	1.200	8-0701202
nickel matt	1.200	8-0701203

Schiene gebogen
rail bent

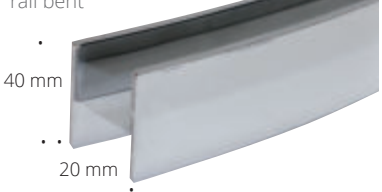

40 mm
20 mm

Doppelschiene Alu/double rail 

Maße/dimensions: B 20 x H 40 mm, r = ... (> 300mm)

Farbe/color	L (mm)	Art.-Nr. item-no.
chrome matt	300	8-060301
chrome	300	8-060302
nickel matt	300	8-060303
chrome matt	500	8-060501
chrome	500	8-060502
nickel matt	500	8-060503
chrome matt	1.200	8-0601201
chrome	1.200	8-0601202
nickel matt	1.200	8-0601203

Eckschiene gebogen 90°
corner rail / bent 90°

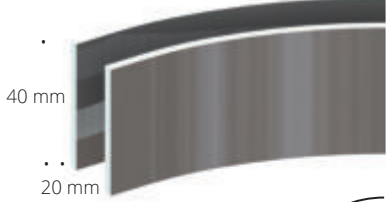

40 mm
20 mm

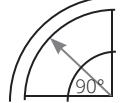

Doppelschiene Alu/double rail 

Maße/dimensions: B 20 x H 40 mm, r ≈ 300mm

Farbe/color	L (mm) Profil rail	Art.-Nr. item-no.
chrome matt	~470	8-080301
chrome	~470	8-080302
nickel matt	~470	8-080303

Fertig gesägt nach Maß und freigegebener Zeichnung. **Art.-Nr. 8-0990

Customized length (after released drawing). **Item no. 8-0990

VERBINDER / CONNECTOR

Verbinder gerade, Abhängung Rohr/Seil
straight connector, suspension tube/wire



Material: Metall/material: metal

Maße/dimensions: B 60 x H 40 x T 30 mm

Farbe/color	Art.-Nr. item-no.
chrome matt	8-0811
chrome	8-0812
nickel matt	8-0813

Verbinder gebogen, Abhängung Rohr/Seil
bent connector, suspension tube/wire



Material: Metall/material: metal

Maße/dimensions: B 60 x H 40 x T 30 mm

Farbe/color	Art.-Nr. item-no.
chrome matt	8-0611
chrome	8-0612
nickel matt	8-0613

Gelenkverbinder, Abhängung Rohr/Seil
articulated connector, suspension tube/wire

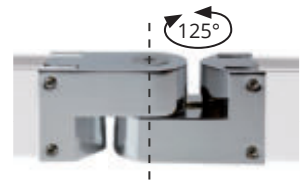

Material: Metall/material: metal

Maße/dimensions: B 90 x H 40 x T 30 mm

Winkel/angle: max. 125°

Farbe/color	Art.-Nr. item-no.
chrome matt	8-0731
chrome	8-0732
nickel matt	8-0733

Adapter für Seilabhängung/for wire suspension

chrome matt	8-0851
chrome	8-0852
nickel matt	8-0853

Adapter für Rohrabhängung/for tube suspension

chrome matt	8-0861
chrome	8-0862
nickel matt	8-0863



Top Line Ceiling components

Standardmodelle auf Seite 218 - 223.

Standard models on page 218 - 223.

HALTER / MOUNTING SUPPORT

Schienehalter beliebig auf Schiene
Abhängung Rohr/Seil
arbitrary support mounting on the rail
suspension tube/wire



Material: Metall/material: metal
Maße/dimensions: B 50 x H 55 x T 40 mm

Farbe/color	Art.-Nr. item-no.
chrome matt	8-0621
chrome	8-0622
nickel matt	8-0623

Schieneendstück (optional)
Abhängung Rohr/Seil
railendpiece (optional)
suspension tube/wire



Material: Metall/material: metal
Maße/dimensions: B 30 x H 40 x T 25 mm

Farbe/color	Art.-Nr. item-no.
chrome matt	8-0841
chrome	8-0842
nickel matt	8-0843

ABHÄNGUNG / SUSPENSION

Rohr Abhängung
tube suspension



Material: Metall/material: metal
Maße/dimensions: H 20 x ø 40 mm

Farbe/color	L mm**	Art.-Nr. item-no.
chrome matt	100	8-06411
chrome	100	8-06412
nickel matt	100	8-06413
chrome matt	200	8-06421
chrome	200	8-06422
nickel matt	200	8-06423
chrome matt	300	8-06431
chrome	300	8-06432
nickel matt	300	8-06433

**Sonderlängen auf Anfrage

**special lengths on request

ABHÄNGUNG / SUSPENSION

Seil Abhängung
wire suspension



Material: Metall/material: metal, max. 29 kg
Maße/dimensions: H 18 x ø 15 mm

Farbe/color	Seil/Rope L mm**	Art.-Nr. item-no.
chrome matt	2.000	8-066120
chrome	2.000	8-066220
nickel matt	2.000	8-066320
chrome matt	5.000	8-066150
chrome	5.000	8-066250
nickel matt	5.000	8-066350

**Sonderlängen auf Anfrage

**special lengths on request

EINSPEISUNG / FEED-IN

Einspeisung mit Abhängung Seil
feed-in with wire suspension



Material: Metall/material: metal
Maße/dimensions: B 65 x H 65 mm

Farbe/color	L mm**	Design	Art.-Nr. item-no.
chrome matt	2.000	<input type="checkbox"/>	8-0661
chrome	2.000	<input type="checkbox"/>	8-0662
nickel matt	2.000	<input type="checkbox"/>	8-0663
chrome matt	2.000	<input type="radio"/>	8-0671
chrome	2.000	<input type="radio"/>	8-0672
nickel matt	2.000	<input type="radio"/>	8-0673

**Sonderlängen auf Anfrage

**special lengths on request

Einspeisung ohne Abhängung
feed-in without wire suspension



Material: Metall/material: metal
Maße/dimensions: B 65 x H 65 mm

Farbe/color	L mm**	Design	Art.-Nr. item-no.
chrome matt	2.000	<input type="checkbox"/>	8-0681
chrome	2.000	<input type="checkbox"/>	8-0682
nickel matt	2.000	<input type="checkbox"/>	8-0683
chrome matt	2.000	<input type="radio"/>	8-0691
chrome	2.000	<input type="radio"/>	8-0692
nickel matt	2.000	<input type="radio"/>	8-0693

**Sonderlängen auf Anfrage

**special lengths on request

Top Line Ceiling Puk heads



Die Puk und Puk Maxx Leuchtenköpfe können in Halogen oder LED zur Bestückung gewählt werden. CHECK I ist ein einfacher Leuchtenkopf, CHECK II ein doppelter Leuchtenkopf und sorgt für noch mehr Licht im Raum.

Standardmodelle auf Seite 218 - 223.



For equipment the Puk and Puk Maxx heads can be chosen in LED or Halogen. CHECK I means a single head, while CHECK II is a double head for much more illumination.

Standard models on page 218 - 223.





Puk Mini Check I LED  2 x 8W ~1.200lm ~2.700k	Puk Check I G9 Fassung 	Gehäuse body
8-160811-LED 8-160812-LED 8-160813-LED	8-160811-H 8-160812-H 8-160813-H	chrome matt chrome nickel matt







Puk Maxx Check I LED  2 x 12W ~1.800lm ~2.700k	Puk Maxx Check I G9 Fassung 	Gehäuse body
8-360811-LED 8-360812-LED 8-360813-LED	8-360811-H 8-360812-H 8-360813-H	chrome matt chrome nickel matt



Puk Mini Check II LED  4 x 8W ~2.400lm ~2.700k	Puk Check II G9 Fassung 	Gehäuse body
8-1609201-LED 8-1609202-LED 8-1609203-LED	8-1609201-H 8-1609202-H 8-1609203-H	chrome matt chrome nickel matt



Puk Maxx Check II LED  4 x 12W ~3.600lm ~2.700k	Puk Maxx Check II G9 Fassung 	Gehäuse body
8-3609201-LED 8-3609202-LED 8-3609203-LED	8-3609201-H 8-3609202-H 8-3609203-H	chrome matt chrome nickel matt

 G9 max. 33W, optional LED Retrofit | Leuchtmittelempfehlung: LED max. 3W/300lm/2.700K/dimmbar  Art Nr. 8-205
G9 max. 33W, LED Retrofit optional | bulb recommendation: LED max. 3W/300Lm/2.700K/dimmable  Item No. 8-205

Bei den Puk Leuchten werden zu dem Leuchtenkopf die Gläser/Linsen und optional die Farbfilter separat dazubestellt! Artikelnummern entnehmen Sie bitte den Equipment-Tabellen auf der Einklappseite.

With the Puk lamps, the glasses, lenses and optional the color filters are ordered separately. Please check the equipment lists on the fold-in page for item numbers.



Top Line Ceiling Puk heads

Die Puk und Puk Maxx Leuchtenköpfe können in Halogen oder LED zur Bestückung gewählt werden. Der Puk Check Turn Leuchtenkopf mit Gelenk erlaubt eine individuelle Einstellung der Beleuchtung.

Standardmodelle auf Seite 218 - 223.

For equipment the Puk and Puk Maxx heads can be chosen in LED or Halogen. By choosing the Puk Turn Head with the joint nearly every individual requirement can be fulfilled.

Standard models on page 218 - 223.



up- & downlight

Puk Mini Turn Check LED G 2 x 8W ~1.200lm ~2.700k	Puk Turn Check G9 Fassung	Gehäuse body
8-1628001-LED 8-1628002-LED 8-1628003-LED	8-1628001-H 8-1628002-H 8-1628003-H	chrome matt chrome nickel matt

up- & downlight

Puk Maxx Turn Check LED G 2 x 12W ~1.800lm ~2.700k	Puk Maxx Turn Check G9 Fassung	Gehäuse body
8-3628001-LED 8-3628002-LED 8-3628003-LED	8-3628001-H 8-3628002-H 8-3628003-H	chrome matt chrome nickel matt

downlight

Puk Mini Turn Check LED G 1 x 8W ~600lm ~2.700k	Puk Turn Check G9 Fassung	Gehäuse body
8-1638001-LED 8-1638002-LED 8-1638003-LED	8-1638001-H 8-1638002-H 8-1638003-H	chrome matt chrome nickel matt

downlight

Puk Maxx Turn Check LED G 1 x 12W ~900lm ~2.700k	Puk Maxx Turn Check G9 Fassung	Gehäuse body
8-3638001-LED 8-3638002-LED 8-3638003-LED	8-3638001-H 8-3638002-H 8-3638003-H	chrome matt chrome nickel matt

G9 max. 33W, optional LED Retrofit | Leuchtmittelpfehlung: LED max. 3W/300lm/2.700K/dimmbar **G** Art Nr. 8-205
 G9 max. 33W, LED Retrofit optional | bulb recommendation: LED max. 3W/300Lm/2.700K/dimmable **G** Item No. 8-205

Bei den Puk Leuchten werden zu dem Leuchtenkopf die Gläser/Linsen und optional die Farbfilter separat dazubestellt! Artikelnummern entnehmen Sie bitte den Equipment-Tabellen auf der Einklappseite.

With the Puk lamps, the glasses, lenses and optional the color filters are ordered separately. Please check the equipment lists on the fold-in page for item numbers.

Top Line Ceiling Puk heads

Die Puk und Puk Maxx Stableuchten Side als Single oder Twin setzen Akzente und konzentrieren Licht, wenn man sie an den wichtigen Stellen ins System einbindet. Auch hier stehen LED Power oder Halogen zur Wahl. Die Armlänge ist 200 mm. Standardmodelle auf Seite 218 - 223.

The Puk and Puk Maxx Side luminaires as single or twin version, provide accents and concentrated light, if they are integrated into the system at important areas. Here, as well, there is a choice of LED Power or halogen. The arm length is 200 mm. Standard models on page 218 - 223.



Puk Mini Side Single Check LED G 2 x 8W ~1.200lm ~2.700k	Puk Side Single Check G9 Fassung	Armlänge arm length	Gehäuse body
8-160831-LED	8-160831-H	200 mm	chrome matt
8-160832-LED	8-160832-H	200 mm	chrome
8-160833-LED	8-160833-H	200 mm	nickel matt



Puk Maxx Side Single Check LED G 2 x 12W ~1.800lm ~2.700k	Puk Maxx Side Single Check G9 Fassung	Armlänge arm length	Gehäuse body
8-360831-LED	8-360831-H	200 mm	chrome matt
8-360832-LED	8-360832-H	200 mm	chrome
8-360833-LED	8-360833-H	200 mm	nickel matt



Puk Mini Side Twin Check LED G 4 x 8W ~2.400lm ~2.700k	Puk Side Twin Check G9 Fassung	Armlänge arm length	Gehäuse body
8-1608511-LED	8-1608511-H	200 mm	chrome matt
8-1608512-LED	8-1608512-H	200 mm	chrome
8-1608513-LED	8-1608513-H	200 mm	nickel matt



Puk Maxx Side Twin Check LED G 4 x 12W ~3.600lm ~2.700k	Puk Maxx Side Twin Check G9 Fassung	Armlänge arm length	Gehäuse body
8-3608511-LED	8-3608511-H	200 mm	chrome matt
8-3608512-LED	8-3608512-H	200 mm	chrome
8-3608513-LED	8-3608513-H	200 mm	nickel matt

G9 max. 33W, optional LED Retrofit | Leuchtmittelpfehlung: LED max. 3W/300lm/2.700K/dimmbar **G** Art Nr. 8-205
 G9 max. 33W, LED Retrofit optional | bulb recommendation: LED max. 3W/300Lm/2.700K/dimmable **G** Item No. 8-205

Bei den Puk Leuchten werden zu dem Leuchtenkopf die Gläser/Linsen und optional die Farbfilter separat dazubestellt! Artikelnummern entnehmen Sie bitte den Equipment-Tabellen auf der Einklappseite.

With the Puk lamps, the glasses, lenses and optional the color filters are ordered separately. Please check the equipment lists on the fold-in page for item numbers.



Top Line Ceiling Puk pendant

Die bewährten Pendelleuchten in Verbindung mit dem System bieten hier noch mehr Varianz. Natürlich in LED Power oder Halogen. Die Seillänge ist 1.300 mm.

More variability with our proved pendant lights in LED or Halogen. The length of the rope is 1.300 mm.

Standardmodelle auf Seite 218 - 223.

Standard models on page 218 - 223.



Puk Mini Long One Check	Puk Long One Check	Seillänge rope length	Gehäuse body
LED G 1 x 8W ~600lm ~2.700k	G9 Fassung		
8-2008001-1-LED	8-2008001-1-H	1.300 mm	chrome matt
8-2008002-1-LED	8-2008002-1-H	1.300 mm	chrome
8-2008003-1-LED	8-2008003-1-H	1.300 mm	nickel matt

Puk Maxx Long One Check	Puk Maxx Long One Check	Seillänge rope length	Gehäuse body
LED G 1 x 12W ~900lm ~2.700k	G9 Fassung		
8-4008001-1-LED	8-4008001-1-H	1.300 mm	chrome matt
8-4008002-1-LED	8-4008002-1-H	1.300 mm	chrome
8-4008003-1-LED	8-4008003-1-H	1.300 mm	nickel matt

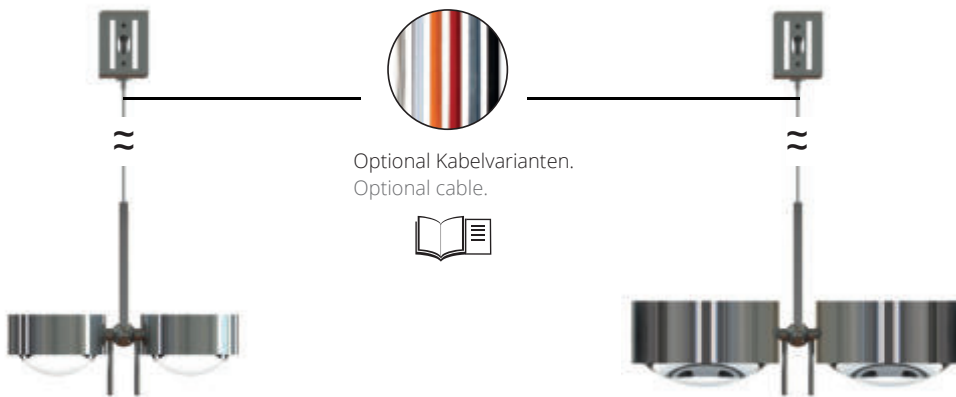

Puk Mini Long Double Check	Puk Long Double Check	Seillänge rope length	Gehäuse body
LED G 4 x 8W ~2.400lm ~2.700k	G9 Fassung		
8-2008001-2-LED	8-2008001-2-H	1.300 mm	chrome matt
8-2008002-2-LED	8-2008002-2-H	1.300 mm	chrome
8-2008003-2-LED	8-2008003-2-H	1.300 mm	nickel matt

Puk Maxx Long Double Check	Puk Maxx Long Double Check	Seillänge rope length	Gehäuse body
LED G 4 x 12W ~3.600lm ~2.700k	G9 Fassung		
8-4008001-2-LED	8-4008001-2-H	1.300 mm	chrome matt
8-4008002-2-LED	8-4008002-2-H	1.300 mm	chrome
8-4008003-2-LED	8-4008003-2-H	1.300 mm	nickel matt

G9 max. 33W, optional LED Retrofit
 Leuchtmittelempfehlung: LED max. 3W/300lm/2.700K/dimmbar **G** Art Nr. 8-205
 G9 max. 33W, LED Retrofit optional
 bulb recommendation: LED max. 3W/300Lm/2.700K/dimmable **G** Item No. 8-205

Bei den Puk Leuchten werden zu dem Leuchtenkopf die Gläser/Linsen und optional die Farbfilter separat dazubestellt! Artikelnummern entnehmen Sie bitte den Equipment-Tabellen auf der Einklappseite.

With the Puk lamps, the glasses, lenses and optional the color filters are ordered separately. Please check the equipment lists on the fold-in page for item numbers.

SYSTEM





Top Line Ceiling Sun pendant

Die Leuchten Sun in ihren drei Größen erweitern das Puk Pendelsystem. Übrigens lassen sich auch systemfremde Pendelleuchten integrieren. Die Seillänge beträgt 1.200 mm.

The lamps Sun with its three sizes expand our Puk pendant system. Furthermore even non-system lights can be integrated. The length of the rope is 1.200 mm.

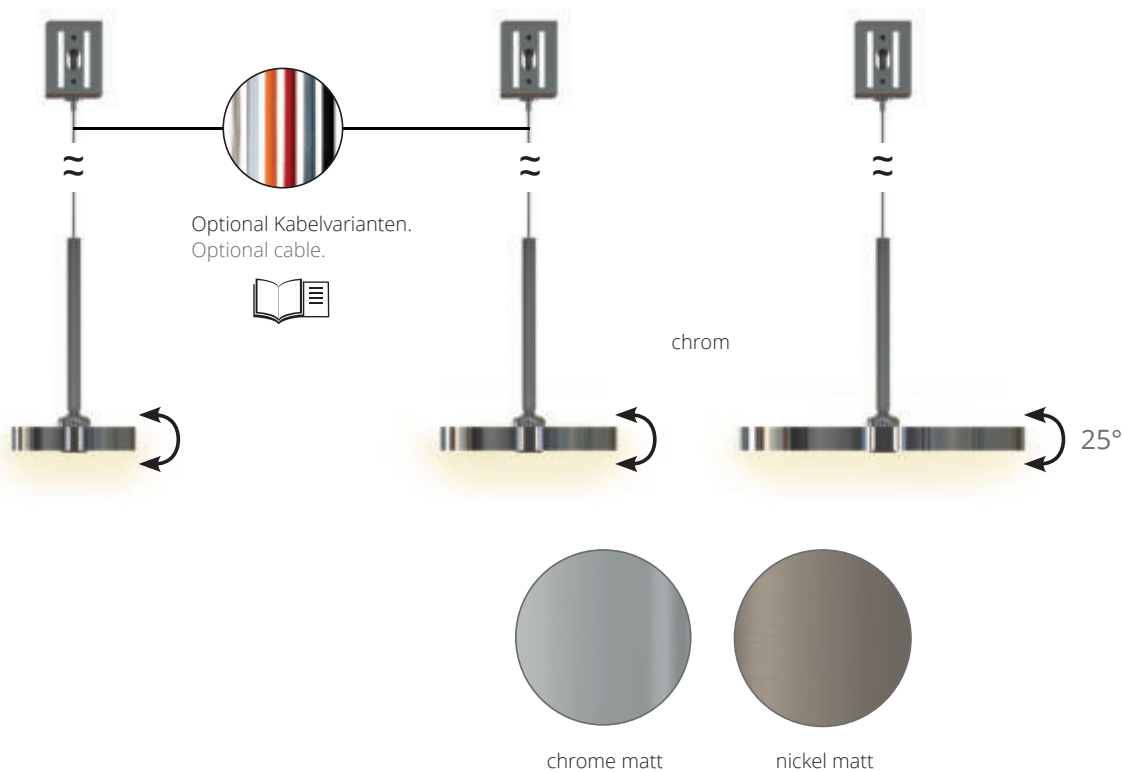

SYSTEM

Sun Swing Down Check ø 90 mm LED G 8W ~600lm ~2.700k	Sun Swing Down Check ø 130 mm LED G 12W ~900lm ~2.700k	Sun Swing Down Check ø 210 mm LED G 16W ~1.200lm ~2.700k	Seillänge rope length	Gehäuse body
8-503289011-LED	8-5032813011-LED	8-5032821011-LED	1.200 mm	chrome matt
8-503289012-LED	8-5032813012-LED	8-5032821012-LED	1.200 mm	chrome
8-503289013-LED	8-5032813013-LED	8-5032821013-LED	1.200 mm	nickel matt

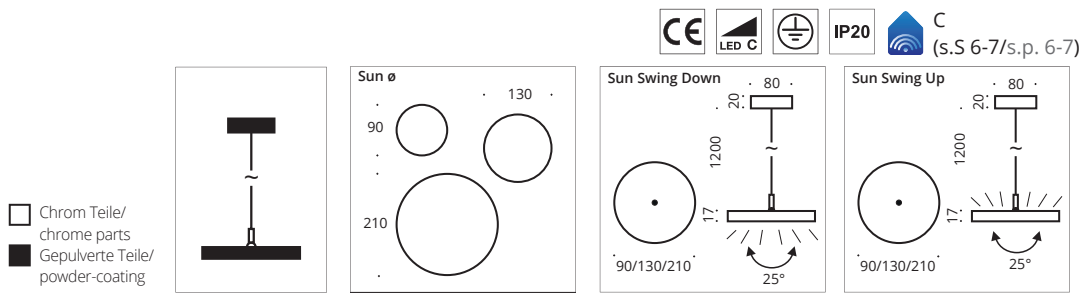

Top Line Ceiling Pela pendant

Die Leuchten Pela und Pela Quadro erweitern das Puk Pendelsystem. Übrigens lassen sich auch systemfremde Pendelleuchten integrieren. Die Seillänge beträgt 1.200 mm.

The lamps Pela and Pela Quadro expand our Puk pendant system. Furthermore even non-system lights can be integrated. The length of the rope is 1.200 mm.



Pela Check L = 1.200 mm E27, ohne LM E27, no lamp	Pela Quadro Check L = 1.200 mm E27, ohne LM E27, no lamp	Gehäuse body
8-5007651-H 8-5007652-H	8-5008651-H 8-5008652-H	chrome nickel matt

E27 max. 42W, optional LED Retrofit
E27 max. 42W, LED Retrofit optional

Leuchtmittelempfehlung: LED max. 9W/800lm/2.700K Art. Nr. 8-309
bulb recommendation: LED max. 9W/800lm/2.700K Item No. 8-309

C (s.S 6-7/s.p. 6-7)



Top Line Ceiling Look at me pendant

Die Leuchte »Look at me« erweitern das Puk Pendelsystem. Übrigens lassen sich auch systemfremde Pendelleuchten integrieren. Die Seillänge beträgt 1.200 mm.

The lamp »Look at me« expand our Puk pendant system. Furthermore even non-system lights can be integrated. The length of the rope is 1.200 mm.

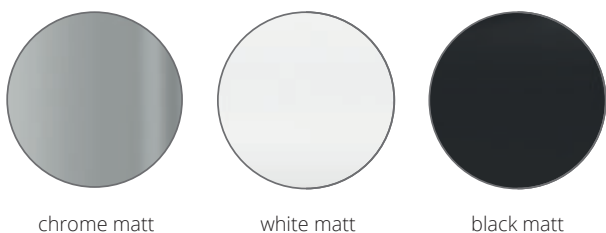

chrome matt

white matt

black matt



Optional Kabelvarianten.
Optional cable.



chrome

SYSTEM

Look at me Check LED L = 1.200 mm G 8W ~600lm ~2.800k	Gehäuse body
8-50911-1-LED	chrome matt
8-50911-2-LED	chrome
8-50911-2-LED-22	white matt
8-50911-2-LED-02	black matt
Separat dazu zu bestellen. For separat order.	
2-9126	lens clear
2-9126-S	lens satined

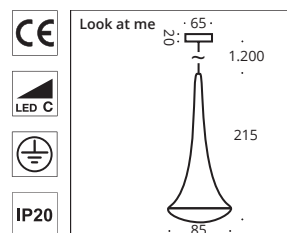

IP20: ABC (s.S 6-7/s.p. 6-7)
IP44: BC (s.S 6-7/s.p. 6-7)





Top Line Gallery

Optimale Beleuchtung für Wände und Bilder. Mit dem Galeriesystem bleibt nichts im Dunkeln. Als Wandabhängung über alle Strecken und Ecken nutzbar. Zur Bestückung können die Puk oder Puk Maxx Leuchtenköpfe in LED oder Halogen gewählt werden. Hier nur einige Konfigurationsbeispiele.

Optimized illumination for walls and pictures. The Puk System Gallery illuminates everything. As wall-fixing for all corners and distances. For equipment the Puk and Puk Maxx heads are available. This page shows a few configuration examples only.

Beispiele Systemführung & Konfiguration

Rail system & configuration examples

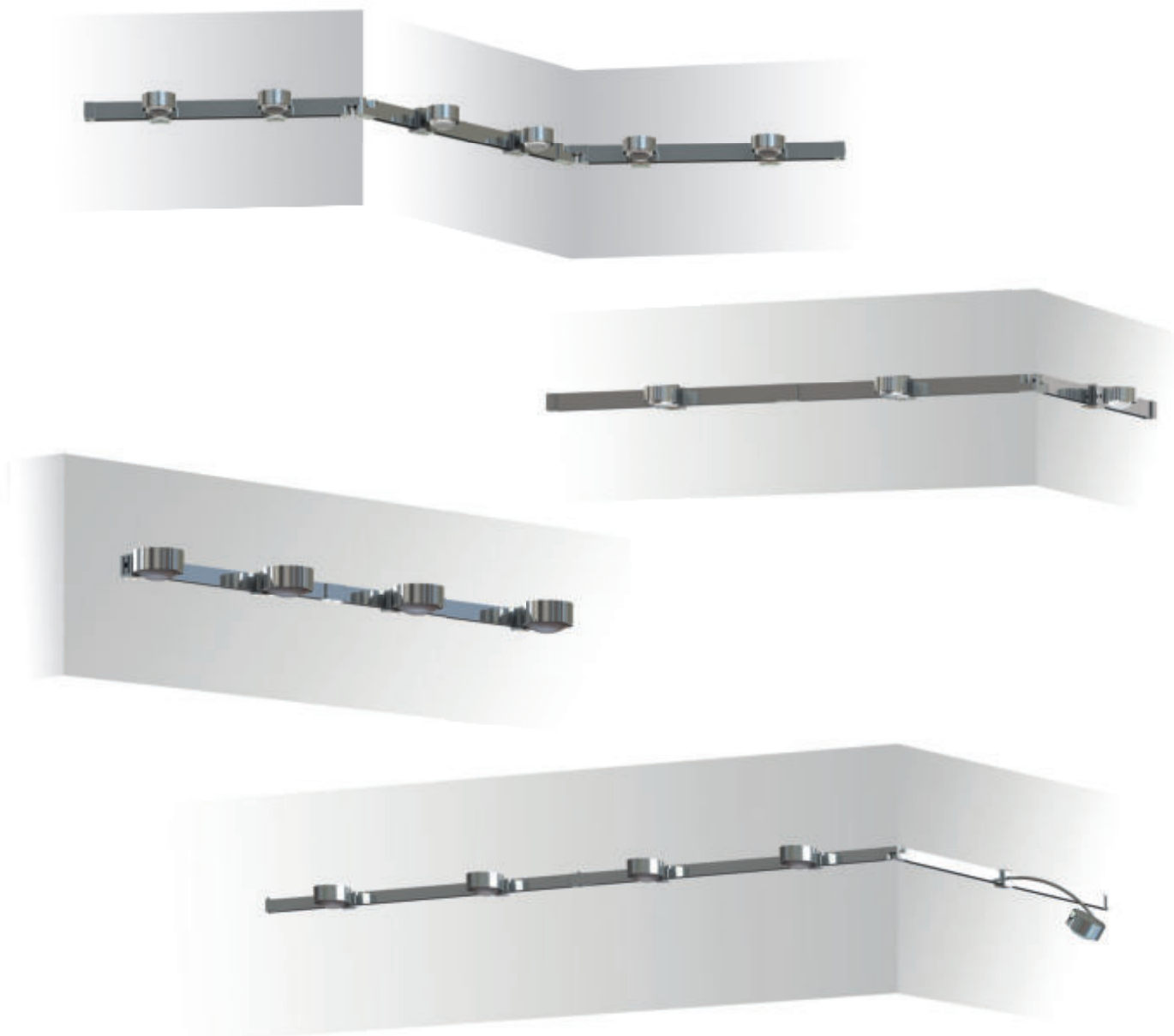

SYSTEM



C (s.S 6-7/s.p. 6-7)

Bei den Puk Leuchten werden zu dem Leuchtenkopf die Gläser/Linsen und optional die Farbfilter separat dazubestellt! Artikelnummern entnehmen Sie bitte den Equipment-Tabellen auf der Einklappseite.

With the Puk lamps, the glasses, lenses and optional the color filters are ordered separately. Please check the equipment lists on the fold-in page for item numbers.

Top Line Gallery components

SCHIENEN (kürzbar**) / RAILS (can be shortened**)

HALTER HALTER / MOUNTING SUPPORT

Schiene gerade
rail straight

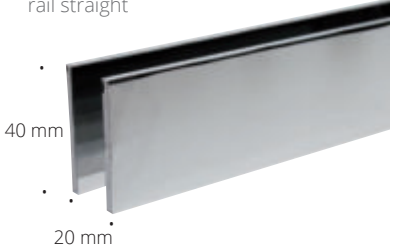

40 mm
20 mm

Doppelschiene Alu/double rail 

Maße/dimensions: B 20 x H 40 mm

Farbe/color	L (mm)	Art.-Nr. item-no.
chrome matt	600	8-070601
chrome	600	8-070602
nickel matt	600	8-070603
chrome matt	1.200	8-0701201
chrome	1.200	8-0701202
nickel matt	1.200	8-0701203

Schienshalter Wandbefestigung
rail support wall mounting



Material: Metall/material: metal

Maße/dimensions: B 50 x H 55 x T 40 mm

Farbe/color	Art.-Nr. item-no.
chrome matt	8-0721
chrome	8-0722
nickel matt	8-0723

Endstück (Wandbefestigungsset muss separat dazu bestellt werden)
railendpiece (wall mounting set is ordered separately)



Material: Metall/material: metal

Maße/dimensions: B 30 x H 40 x T 25 mm

Farbe/color	Art.-Nr. item-no.
chrome matt	8-0841
chrome	8-0842
nickel matt	8-0843

Fertig gesägt nach Maß und freigegebener Zeichnung **Art.-Nr. 8-0990**

Customized length (after released drawing) **Item no. 8-0990**

VERBINDER / CONNECTOR

ZUBEHÖR / EQUIPMENT

Verbinder gerade (Wandbefestigungsset muss separat dazu bestellt werden)
straight connector (wall mounting set is ordered separately)



Material: Metall/material: metal

Maße/dimensions: B 60 x H 40 x T 30 mm

Farbe/color	Art.-Nr. item-no.
chrome matt	8-0811
chrome	8-0812
nickel matt	8-0813

Gelenkverbinder für Winkelmontage
articulated connector for bracket mounting

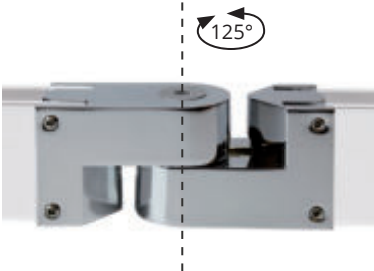

Material: Metall/material: metal

Maße/dimensions: B 90 x H 40 x T 30 mm

Winkel/angle: max. 125°

Farbe/color	Art.-Nr. item-no.
chrome matt	8-0731
chrome	8-0732
nickel matt	8-0733

Wandbefestigungsset**
wall mounting set**



**Für Verbinder gerade und Endstück
**for straight connector and railendpiece

Material: Metall/material: metal

Maße/dimensions: B 20 x H 40 x T 32 mm

Farbe/color	Art.-Nr. item-no.
steel	8-078



Top Line Gallery components

EINSPEISUNG / FEED-IN

ZUBEHÖR / EQUIPMENT

Wand-, Deckeneinspeisung
feed-in for wall and ceiling



Material: Metall/material: metal

Maße/dimensions: B 65 x H 65 mm

Farbe/color	L mm**	Design	Art.-Nr. item-no.
chrome matt	1.200	□	8-0761
chrome	1.200	□	8-0762
nickel matt	1.200	□	8-0763
chrome matt	1.200	○	8-0771
chrome	1.200	○	8-0772
nickel matt	1.200	○	8-0773

**Sonderlängen auf Anfrage

**special lengths on request

2 Bilderhalter**
2 picture holder**



Montage auf der wandseitigen Schiene
Assembly on the wall side rail

Material: Metall/material: metal

Maße/dimensions: B 20 x H 40 x T 5 mm

Farbe/color	Art.-Nr. item-no.
nickel	8-0753

**Lieferung ohne Seil zur Abhängung

**delivery without wire for suspension

Deco-Knopf decorative knob

Bei Leuchtkopfbestellung
Deco-Knopf separat dazu zu
bestellen.

Decorative knob for
illuminated heads for
separat order.



Art. Nr. item no.	Farbe color
8-07501	chrome matt
8-07502	chrome
8-07503	nickel matt





Top Line Gallery Puk heads

Die Puk und Puk Maxx Leuchtenköpfe können in Halogen oder LED zur Bestückung gewählt werden. CHECK I ist ein einfacher Leuchtenkopf. Puk Rainbow mit gebogenem Stab setzt Ihre Bilder optimal in Szene.

For equipment the Puk and Puk Maxx heads are available. CHECK I is a single head. The bend tube Puk Rainbow sets the scene effectively.



Puk Mini
Check I
LED **G**
2 x 8W
~1.200lm ~2.700k

Puk Mini
Check I
G9 Fassung



Gehäuse
body

8-160811-LED
8-160812-LED
8-160813-LED

8-160811-H
8-160812-H
8-160813-H

chrome matt
chrome
nickel matt



Puk Maxx
Check I
LED **G**
2 x 12W
~1.800lm ~2.700k

Puk Maxx
Check I
G9 Fassung



Gehäuse
body

8-360811-LED
8-360812-LED
8-360813-LED

8-360811-H
8-360812-H
8-360813-H

chrome matt
chrome
nickel matt

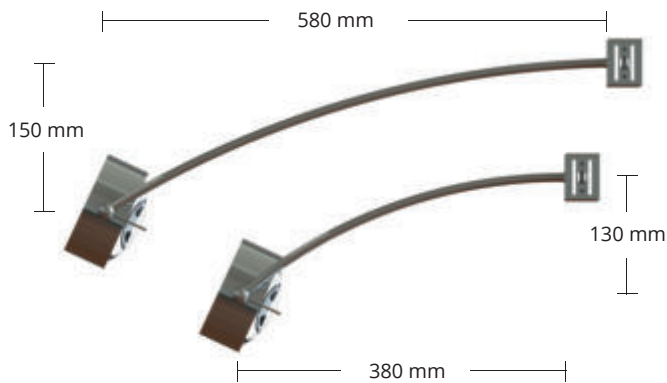

Puk Rainbow
400 mm G9



Puk Rainbow
600 mm G9



Gehäuse
body

8-1708401-H
8-1708402-H
8-1708403-H

8-1708601-H
8-1708602-H
8-1708603-H

chrome matt
chrome
nickel matt

G9 max. 33W, optional LED Retrofit
 G9 max. 33W, LED Retrofit optional

Leuchtmittelempfehlung: LED max. 3W/300lm/2.700K/dimmbar

G Art Nr. 8-205
 bulb recommendation: LED max. 3W/300Lm/2.700K/dimmable
 Item No. 8-205

Puk Rainbow
400 mm
LED 2 x 8W
G
~1.200lm ~2.700k

Puk Rainbow
400 mm
LED 1 x 8W
G
~600lm ~2.700k

Gehäuse
body

8-1708401-LED
8-1708402-LED
8-1708403-LED

8-1708411-LED
8-1708412-LED
8-1708413-LED

chrome matt
chrome
nickel matt

Puk Rainbow
600 mm
LED 2 x 8W
G
~1.200lm ~2.700k

Puk Rainbow
600 mm
LED 1 x 8W
G
~600lm ~2.700k

Gehäuse
body

8-1708601-LED
8-1708602-LED
8-1708603-LED

8-1708611-LED
8-1708612-LED
8-1708613-LED

chrome matt
chrome
nickel matt

Bei den Puk Leuchten werden zu dem Leuchtenkopf die Gläser/Linsen und optional die Farbfilter separat dazubestellt! Artikelnummern entnehmen Sie bitte den Equipment-Tabellen auf der Einklappseite.

With the Puk lamps, the glasses, lenses and optional the color filters are ordered separately. Please check the equipment lists on the fold-in page for item numbers.



Top Line System Crown



Top Line Crown

Ein Kronleuchter nach Maß und nach Ihren Anforderungen. Kreieren Sie sich die Puk System Crown nach Ihren Wünschen und Bedürfnissen. Als LED oder Halogen Variante mit den Leuchtenköpfen der Puk oder Puk Maxx Serie. Hier nur einige Konfigurationsbeispiele.

A customized chandelier for every requirement. Create your own chandelier according to your needs. The Crown is equipped with the Puk and Puk Maxx heads in LED or Halogen. Here are just a few configuration examples.

Beispiele Systemführung & Konfiguration

Rail system & configuration examples

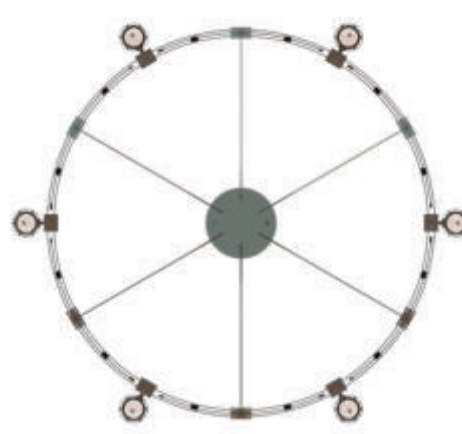
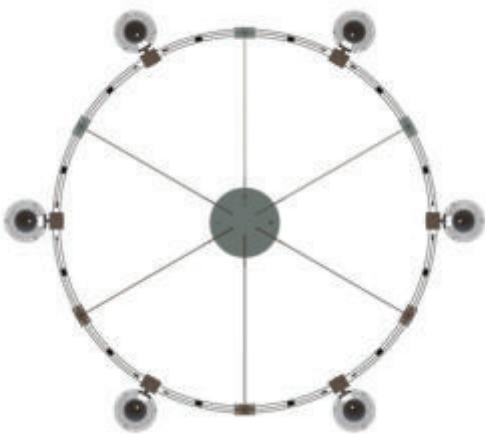
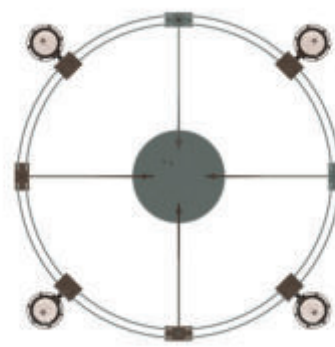
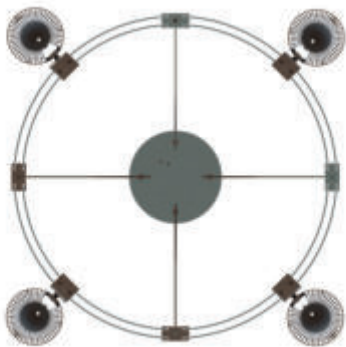

SYSTEM

Bei den Puk Leuchten werden zu dem Leuchtenkopf die Gläser/Linsen und optional die Farbfilter separat dazubestellt! Artikelnummern entnehmen Sie bitte den Equipment-Tabellen auf der Einklappseite.

With the Puk lamps, the glasses, lenses and optional the color filters are ordered separately. Please check the equipment lists on the fold-in page for item numbers.



C (s.S 6-7/s.p. 6-7)





Top Line Crown Configuration

D = geplanter Durchmesser der Crown
V = Anzahl der benötigten gebogenen Verbinder

D = planned diameter of the Crown
V = number of required bent connectors

Standardmodelle auf Seite 210 - 217.

Standard models on page 210 - 217.

D \ V	3	4	5	6	7	8	9	10	11	12	14	16
600 mm	✓											
800 mm		✓										
1.200 mm				✓								
1.500 mm				✓								
1.800 mm				✓								
2.500 mm						✓						
3.000 mm						✓						
3.500 mm								✓				
4.000 mm										✓		
4.500 mm											✓	
5.000 mm												✓

SYSTEM

Regulär wird empfohlen, an den Verbindern/Endstücken abzuhängen. Aus optischen oder technischen Gründen kann aber auch auf andere Möglichkeiten, wie die Tabelle zeigt, zurückgegriffen werden. Die empfohlene Anzahl von Verbindern in der Tabelle entspricht auch den benötigten Seil- oder Rohrabhängungen.

We recommend to hang up the system on the connectors or end pieces. For optical or technical reasons the above listed possibilities can be taken in consideration as well.

Top Line Crown components

Standardmodelle auf Seite 210 - 217. Standard models on page 210 - 217.

SCHIENEN (kürzbar) / RAILS (can be shortened)

Schiene gebogen
rail bent

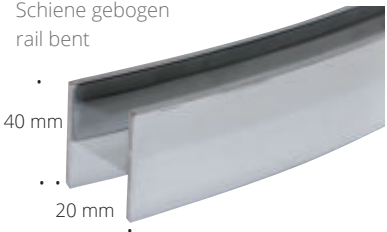

40 mm
20 mm

Doppelschiene Alu/double rail
Maße/dimensions: B 20 x H 40 mm, r = ... (> 300mm)

Farbe/color	L (mm)	Art.-Nr. item-no.
chrome matt	300	8-060301
chrome	300	8-060302
nickel matt	300	8-060303
chrome matt	500	8-060501
chrome	500	8-060502
nickel matt	500	8-060503
chrome matt	1.200	8-0601201
chrome	1.200	8-0601202
nickel matt	1.200	8-0601203

VERBINDER / CONNECTOR

Verbinder gebogen, Abhängung Rohr/Seil
bent connector, suspension tube/wire



Material: Metall/material: metal
Maße/dimensions: B 60 x H 40 x T 30 mm

Farbe/color	Art.-Nr. item-no.
chrome matt	8-0611
chrome	8-0612
nickel matt	8-0613

HALTER / MOUNTING SUPPORT

Halter für freie Pendel Montage,
Abhängung Rohr/Seil
mounting support for pendula mounting,
suspension tube/wire



Material: Metall/material: metal
Anschluss: M10 x 1
Maße/dimensions: B 50 x H 55 x T 40 mm

Farbe/color	Art.-Nr. item-no.
chrome matt	8-0621
chrome	8-0622
nickel matt	8-0623

Verbindungskabel, Elektroklemmen und Kabelarretierung liegen ausreichend bei. Connecting cables, luster terminals and cable locks are enclosed.

ABHÄNGUNG / SUSPENSION

Rohr Abhängung
tube suspension



Material: Metall/material: metal
Maße/dimensions: H 20 x ø 40 mm

Farbe/color	L mm**	Art.-Nr. item-no.
chrome matt	100	8-06411
chrome	100	8-06412
nickel matt	100	8-06413
chrome matt	200	8-06421
chrome	200	8-06422
nickel matt	200	8-06423
chrome matt	300	8-06431
chrome	300	8-06432
nickel matt	300	8-06433

Seil Abhängung
wire suspension



Material: Metall/material: metal, max. 29 kg
Maße/dimensions: H 18 x ø 15 mm

Farbe/color	Seil/Rope L mm**	Art.-Nr. item-no.
chrome matt	2.000	8-066120
chrome	2.000	8-066220
nickel matt	2.000	8-066320
chrome matt	5.000	8-066150
chrome	5.000	8-066250
nickel matt	5.000	8-066350

EINSPEISUNG / FEED-IN

Baldachin mit Abhängung für bis
ø = < 180 cm (s. Crown Configuration)
baldachin with suspension for up to
ø = < 180 cm (s. Crown Configuration)



Anwendbar für 3 Etagen Crown
Seilabhängung + Einspeisung sind separat
zu bestellen
applicable for 3-level chandelier
wire suspension + feed in for separat order
Material: Metall/material: metal
Maße/dimensions: ø 200 mm

Farbe/color	Art.-Nr. item-no.
chrome matt	8-0631
chrome	8-0632
nickel matt	8-0633

**Sonderlängen auf Anfrage
**special lengths on request

**Sonderlängen auf Anfrage
**special lengths on request



Top Line Crown components

Standardmodelle auf Seite 210 - 217. Standard models on page 210 - 217.

EINSPEISUNG / FEED-IN

Einspeisung mit Abhängung
feed-in with wire suspension

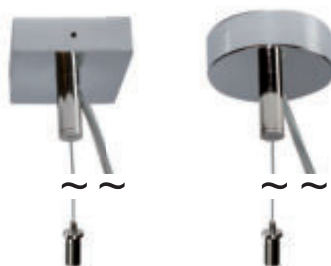

Material: Metall/material: metal

Maße/dimensions: B 65 x H 65 mm

Farbe/color	L mm**	Design	Art.-Nr. item-no.
chrome matt	2.000	□	8-0661
chrome	2.000	□	8-0662
nickel matt	2.000	□	8-0663
chrome matt	2.000	○	8-0671
chrome	2.000	○	8-0672
nickel matt	2.000	○	8-0673

Einspeisung ohne Abhängung
feed-in without wire suspension



Material: Metall/material: metal

Maße/dimensions: B 65 x H 65 mm

Farbe/color	L mm**	Design	Art.-Nr. item-no.
chrome matt	2.000	□	8-0681
chrome	2.000	□	8-0682
nickel matt	2.000	□	8-0683
chrome matt	2.000	○	8-0691
chrome	2.000	○	8-0692
nickel matt	2.000	○	8-0693

**Sonderlängen auf Anfrage **special lengths on request **Sonderlängen auf Anfrage **special lengths on request

ABHÄNGUNG / SUSPENSION

Sammelabhängung für hohe Decken – auf Anfrage
collected suspension for high ceiling – on request



Anwendbar für bis zu 3 Etagen Crown
Applicable for up to 3-level chandelier

Material: Metall/material: metal

Maße/dimensions: ø 200 mm

Farbe/color	Art.-Nr. item-no.
chrome matt	8-06531
chrome	8-06532
nickel matt	8-06533

EINSPEISUNG / FEED-IN

Seil Abhängung für Baldachin
(8-0631-33 s. links)
wire suspension for baldachin
(8-0631-33 s. left)



Material: Metall/material: metal
kürzbar/can be shortened

Farbe/color Länge/length	Art.-Nr. item-no.
nickel L = 2.000 mm**	8-0992
nickel L = 5.000 mm**	8-0991

Einspeisung Kabel, 3 pol. transparent
feed-in cable, 3-pole cable transparent



Pro Ring 1 Einspeisung/ 1 feed-in per ring
kürzbar/can be shortened

Farbe/color Länge/length	Art.-Nr. item-no.
transp. L = 2.000 mm**	8-0993
transp. L = 5.000 mm**	8-0994

**Sonderlängen auf Anfrage **special lengths on request **Sonderlängen auf Anfrage **special lengths on request

ZUBEHÖR / EQUIPMENT

Deco-Knopf decorative knob

Bei Leuchtkopfbestellung
Deco-Knopf separat dazu zu
bestellen.

Decorative knob for
illuminated heads for
separat order.



Art. Nr. item no.	Farbe color
8-07501	chrome matt
8-07502	chrome
8-07503	nickel matt

Top Line Crown Puk heads



Die Puk und Puk Maxx Leuchtenköpfe können in Halogen oder LED zur Bestückung gewählt werden. CHECK I ist ein einfacher Leuchtenkopf, CHECK II ein doppelter Leuchtenkopf und sorgt für noch mehr Licht im Raum.

For equipment the Puk and Puk Maxx heads can be chosen in LED or Halogen. CHECK I means a single head, while CHECK II is a double head for much more illumination.



Standardmodelle auf Seite 210 - 217.

Standard models on page 210 - 217.





Puk Mini Check I LED  2 x 8W ~1.200lm ~2.700k	Puk Check I G9 Fassung 	Gehäuse body
8-160811-LED 8-160812-LED 8-160813-LED	8-160811-H 8-160812-H 8-160813-H	chrome matt chrome nickel matt







Puk Maxx Check I LED  2 x 12W ~1.800lm ~2.700k	Puk Maxx Check I G9 Fassung 	Gehäuse body
8-360811-LED 8-360812-LED 8-360813-LED	8-360811-H 8-360812-H 8-360813-H	chrome matt chrome nickel matt



Puk Mini Check II LED  4 x 8W ~2.400lm ~2.700k	Puk Check II G9 Fassung 	Gehäuse body
8-1609201-LED 8-1609202-LED 8-1609203-LED	8-1609201-H 8-1609202-H 8-1609203-H	chrome matt chrome nickel matt



Puk Maxx Check II LED  4 x 12W ~3.600lm ~2.700k	Puk Maxx Check II G9 Fassung 	Gehäuse body
8-3609201-LED 8-3609202-LED 8-3609203-LED	8-3609201-H 8-3609202-H 8-3609203-H	chrome matt chrome nickel matt

 G9 max. 33W, optional LED Retrofit | Leuchtmittelempfehlung: LED max. 3W/300lm/2.700K/dimmbar  Art Nr. 8-205
G9 max. 33W, LED Retrofit optional | bulb recommendation: LED max. 3W/300Lm/2.700K/dimmable  Item No. 8-205

Bei den Puk Leuchten werden zu dem Leuchtenkopf die Gläser/Linsen und optional die Farbfilter separat dazubestellt! Artikelnummern entnehmen Sie bitte den Equipment-Tabellen auf der Einklappseite.

With the Puk lamps, the glasses, lenses and optional the color filters are ordered separately. Please check the equipment lists on the fold-in page for item numbers.



Top Line Crown Puk heads

Die Puk und Puk Maxx Leuchtenköpfe können in Halogen oder LED zur Bestückung gewählt werden. Der Puk Check Turn Leuchtenkopf mit Gelenk erlaubt eine individuelle Einstellung der Beleuchtung.

For equipment the Puk and Puk Maxx heads can be chosen in LED or Halogen. By choosing the Puk Turn Head with the joint nearly every individual requirement can be fulfilled.

Standardmodelle auf Seite 210 - 217.

Standard models on page 210 - 217.



up- & downlight

Puk Mini Turn
Check
LED **G**
2 x 8W
~1.200lm ~2.700k

Puk Turn
Check
G9 Fassung

Gehäuse
body

8-1628001-LED
8-1628002-LED
8-1628003-LED

8-1628001-H
8-1628002-H
8-1628003-H

chrome matt
chrome
nickel matt

up- & downlight

Puk Maxx Turn
Check
LED **G**
2 x 12W
~1.800lm ~2.700k

Puk Maxx Turn
Check
G9 Fassung

Gehäuse
body

8-3628001-LED
8-3628002-LED
8-3628003-LED

8-3628001-H
8-3628002-H
8-3628003-H

chrome matt
chrome
nickel matt

downlight

Puk Mini Turn
Check
LED **G**
1 x 8W
~600lm ~2.700k

Puk Turn
Check
G9 Fassung

Gehäuse
body

8-1638001-LED
8-1638002-LED
8-1638003-LED

8-1638001-H
8-1638002-H
8-1638003-H

chrome matt
chrome
nickel matt

downlight

Puk Maxx Turn
Check
LED **G**
1 x 12W
~900lm ~2.700k

Puk Maxx Turn
Check
G9 Fassung

Gehäuse
body

8-3638001-LED
8-3638002-LED
8-3638003-LED

8-3638001-H
8-3638002-H
8-3638003-H

chrome matt
chrome
nickel matt

G9 max. 33W, optional LED Retrofit
G9 max. 33W, LED Retrofit optional

Leuchtmittelempfehlung: LED max. 3W/300lm/2.700K/dimmbar **G** Art Nr. 8-205
bulb recommendation: LED max. 3W/300Lm/2.700K/dimmable **G** Item No. 8-205

Bei den Puk Leuchten werden zu dem Leuchtenkopf die Gläser/Linsen und optional die Farbfilter separat dazubestellt! Artikelnummern entnehmen Sie bitte den Equipment-Tabellen auf der Einklappseite.

With the Puk lamps, the glasses, lenses and optional the color filters are ordered separately. Please check the equipment lists on the fold-in page for item numbers.

Top Line Crown Puk heads



Die Puk und Puk Maxx Stableuchten Side als Single oder Twin setzen Akzente und konzentrieren Licht, wenn man sie an den wichtigen Stellen ins System einbindet. Auch hier stehen LED Power oder Halogen zur Wahl. Die Armlänge ist 200 mm.

The Puk and Puk Maxx Side luminaires as single or twin version, provide accents and concentrated light, if they are integrated into the system at important areas. Here, as well, there is a choice of LED Power or halogen. The arm length is 200 mm.



Standardmodelle auf Seite 210 - 217.

Standard models on page 210 - 217.





Puk Mini Side Single Check LED  2 x 8W ~1.200lm ~2.700k	Puk Side Single Check G9 Fassung 	Armlänge arm length	Gehäuse body
8-160831-LED	8-160831-H	200 mm	chrome matt
8-160832-LED	8-160832-H	200 mm	chrome
8-160833-LED	8-160833-H	200 mm	nickel matt







Puk Maxx Side Single Check LED  2 x 12W ~1.800lm ~2.700k	Puk Maxx Side Single Check G9 Fassung 	Armlänge arm length	Gehäuse body
8-360831-LED	8-360831-H	200 mm	chrome matt
8-360832-LED	8-360832-H	200 mm	chrome
8-360833-LED	8-360833-H	200 mm	nickel matt



Puk Mini Side Twin Check LED  4 x 8W ~2.400lm ~2.700k	Puk Side Twin Check G9 Fassung 	Armlänge arm length	Gehäuse body
8-1608511-LED	8-1608511-H	200 mm	chrome matt
8-1608512-LED	8-1608512-H	200 mm	chrome
8-1608513-LED	8-1608513-H	200 mm	nickel matt



Puk Maxx Side Twin Check LED  4 x 12W ~3.600lm ~2.700k	Puk Maxx Side Twin Check G9 Fassung 	Armlänge arm length	Gehäuse body
8-3608511-LED	8-3608511-H	200 mm	chrome matt
8-3608512-LED	8-3608512-H	200 mm	chrome
8-3608513-LED	8-3608513-H	200 mm	nickel matt

 G9 max. 33W, optional LED Retrofit | Leuchtmittelpfehlung: LED max. 3W/300lm/2.700K/dimmbar  Art Nr. 8-205
G9 max. 33W, LED Retrofit optional | bulb recommendation: LED max. 3W/300Lm/2.700K/dimmable  Item No. 8-205

Bei den Puk Leuchten werden zu dem Leuchtenkopf die Gläser/Linsen und optional die Farbfilter separat dazubestellt! Artikelnummern entnehmen Sie bitte den Equipment-Tabellen auf der Einklappseite.

With the Puk lamps, the glasses, lenses and optional the color filters are ordered separately. Please check the equipment lists on the fold-in page for item numbers.



Top Line Crown Puk pendant

Die bewährten Pendelleuchten in Verbindung mit dem System bieten hier noch mehr Varianz. Natürlich in LED Power oder Halogen. Die Seillänge ist 1.300 mm.

More variability with our proved pendant lights in LED or Halogen. The length of the rope is 1.300 mm.

Standardmodelle auf Seite 210 - 217.

Standard models on page 210 - 217.

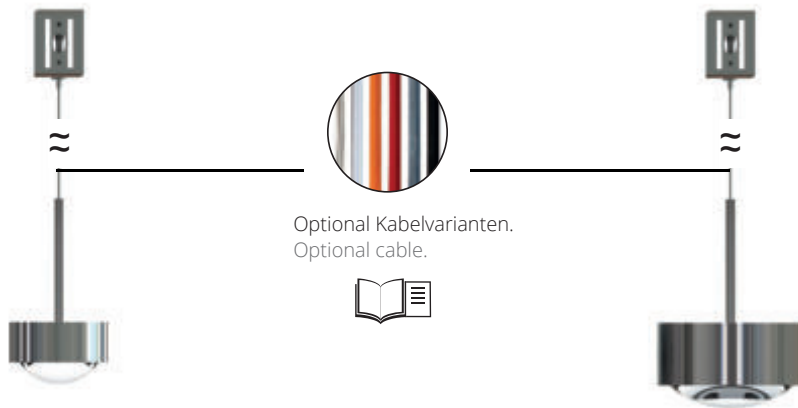

Puk Mini Long One Check LED G 1 x 8W ~600lm ~2.700k	Puk Long One Check G9 Fassung	Seillänge rope length 	Gehäuse body
8-2008001-1-LED	8-2008001-1-H	1.300 mm	chrome matt
8-2008002-1-LED	8-2008002-1-H	1.300 mm	chrome
8-2008003-1-LED	8-2008003-1-H	1.300 mm	nickel matt

Puk Maxx Long One Check LED G 1 x 12W ~900lm ~2.700k	Puk Maxx Long One Check G9 Fassung 	Seillänge rope length	Gehäuse body
8-4008001-1-LED	8-4008001-1-H	1.300 mm	chrome matt
8-4008002-1-LED	8-4008002-1-H	1.300 mm	chrome
8-4008003-1-LED	8-4008003-1-H	1.300 mm	nickel matt

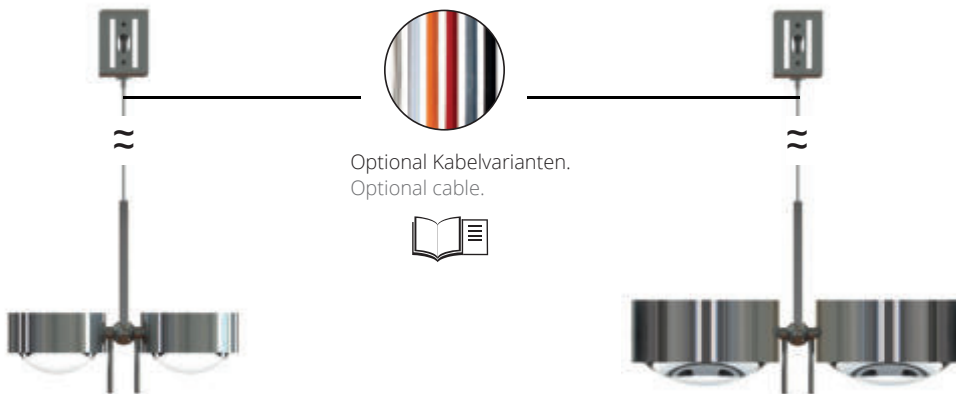

Puk Mini Long Double Check LED G 4 x 8W ~2.400lm ~2.700k	Puk Long Double Check G9 Fassung	Seillänge rope length 	Gehäuse body
8-2008001-2-LED	8-2008001-2-H	1.300 mm	chrome matt
8-2008002-2-LED	8-2008002-2-H	1.300 mm	chrome
8-2008003-2-LED	8-2008003-2-H	1.300 mm	nickel matt

Puk Maxx Long Double Check LED G 4 x 12W ~3.600lm ~2.700k	Puk Maxx Long Double Check G9 Fassung 	Seillänge rope length	Gehäuse body
8-4008001-2-LED	8-4008001-2-H	1.300 mm	chrome matt
8-4008002-2-LED	8-4008002-2-H	1.300 mm	chrome
8-4008003-2-LED	8-4008003-2-H	1.300 mm	nickel matt

G9 max. 33W, optional LED Retrofit
 Leuchtmittelempfehlung: LED max. 3W/300lm/2.700K/dimmbar **G** Art Nr. 8-205
 G9 max. 33W, LED Retrofit optional
 bulb recommendation: LED max. 3W/300Lm/2.700K/dimmable **G** Item No. 8-205

Bei den Puk Leuchten werden zu dem Leuchtenkopf die Gläser/Linsen und optional die Farbfilter separat dazubestellt! Artikelnummern entnehmen Sie bitte den Equipment-Tabellen auf der Einklappseite.

With the Puk lamps, the glasses, lenses and optional the color filters are ordered separately. Please check the equipment lists on the fold-in page for item numbers.

SYSTEM





Top Line Elektrifizierung

Top Line Electrification

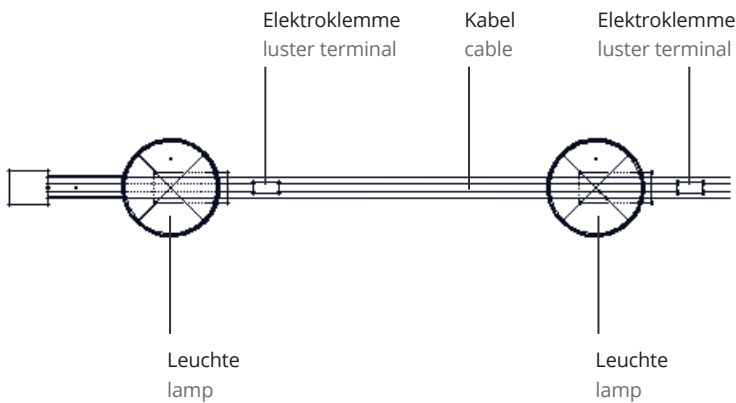

Erdung durch Madenschraube am Kopfhalter

Grounded through headless screw on holder.

1. das Kabel durch Verbindler/Innenschiene.
2. Einspeisung im System anschließbar.

1. cable through the connector/inner rail
2. feed-in connection with the system

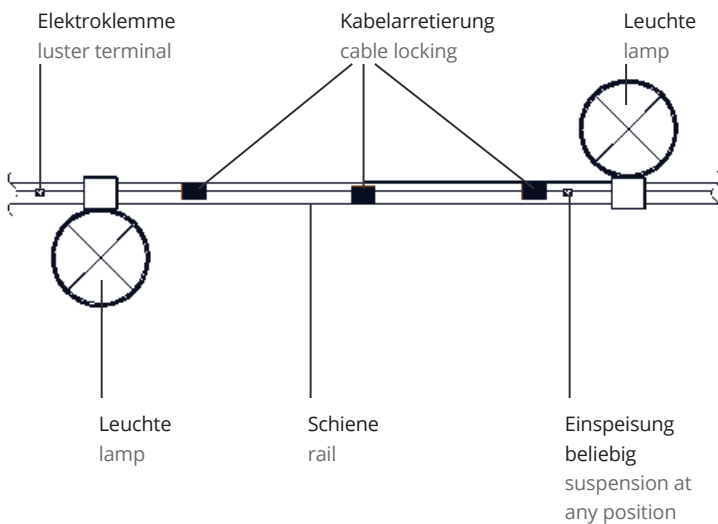

Kabelarretierung einseitig klebbar, versetzt zwischen der Doppelschiene.

One side cable locking in between the double rail.

Verbindungskabel, Elektroklemmen und Kabelarretierungen liegen bei jeder Schiene ausreichend bei.

Connecting cables, luster terminals and cable locks are enclosed.

Systemelektrifizierung nur durch autorisierte Elektrofachkraft.
Kabelenden sind mit Aderendhülsen für 0,75 mm² zu versehen.

Electrification through an authorized electrician only. Wire ends have to be equipped with wire ferrules with 0,75 mm².

SYSTEM





Eutrac Puk Mini

Die Puk Mini Köpfe mit passendem Adapter funktionieren mit allen 1- oder 3-Phasen Eutrac Schienen-Modellen. Auf der Seite der Puk-Leuchte finden Sie die Art.-Nr., die Sie mit der Nummer des passenden Eutrac-Adapters von dieser Seite kombinieren.

The Puk Mini heads with matching adapter work with all 1- or 3-phase Eutrac track models. On the page of the Puk luminaire you will find the art. no., which you combine with the number of the matching Eutrac adapter found on this page.



Puk Mini Turn
Seite 29



Puk Mini Eye
Seite 37



Puk Mini Side
Seite 43



Puk Mini Flexlight
Seite 149



Puk Mini Drop
Seite 193



Puk Mini Long One
Seite 187



Puk Mini Long Double
Seite 187

1-Phasen-Adapter



3-Phasen-Adapter



SYSTEM

Adapter Gehäuse
adapter body

Art. Nr. Anhang für 1 Phase
for 1 Phase attach behind
the item no.

Art. Nr. Anhang für 3 Phasen
for 3 Phases attach behind
the item no.

black
white
silver

ci1-sw
ci1-w
ci1-s

ci3-sw
ci3-w
ci3-s





Eutrac Puk Maxx

Die Puk Maxx Köpfe mit passendem Adapter funktionieren mit allen 1- oder 3-Phasen Eutrac Schienen-Modellen. Auf der Seite der Puk-Leuchte finden Sie die Art.-Nr., die Sie mit der Nummer des passenden Eutrac-Adapters von dieser Seite kombinieren.

The Puk Maxx heads with matching adapter work with all 1- or 3-phase Eutrac track models. On the page of the Puk luminaire you will find the art. no., which you combine with the number of the matching Eutrac adapter found on this page.



Puk Maxx Turn
Seite 31



Puk Maxx Eye
Seite 39



Puk Maxx Side
Seite 45



Puk Mini Flexlight
Seite 59



Puk Maxx Drop
Seite 195



Puk Maxx Long One
Seite 189



Puk Maxx Long Double
Seite 189

1-Phasen-Adapter



3-Phasen-Adapter



Adapter Gehäuse
adapter body

Art. Nr. Anhang für 1 Phase
for 1 Phase attach behind
the item no.

Art. Nr. Anhang für 3 Phasen
for 3 Phases attach behind
the item no.

black
white
silver

ci1-sw
ci1-w
ci1-s

ci3-sw
ci3-w
ci3-s





Allround Track ø 120/160/240

Diese dimmbare Leuchte wurde für die Anbringung auf einer 1PH oder 3PH Eurtrac Schiene konstruiert. Mit zwei kardanisch aufeinander abgestimmten Gelenken, lassen sich die LED Leuchtenköpfe um über 360 Grad drehen. Mit drei Leuchtenkopfdurchmessern (ø120mm/8W/920lm, ø160mm/12W/1300lm, ø240mm/16W/1600lm), durchgängig 2700k), lassen sich die Leuchten für viele Anwendungen im Privat- oder Objektbereich einplanen.

This dimmable luminaire is designed to be mounted on a 1PH or PPH Eurtrac track. With two gimbal-mounted joints, the LED luminaire heads can be rotated more than 360°. With three luminaire head diameters (ø120mm/8W/920lm, ø160mm/12W/1300lm, ø240mm/16W/1600lm), the luminaires can be planned for many applications in the residential and public sectors.

Allround in Bewegung (Wandbefestigung) Allround in motion (wall mounting)



Allround in Bewegung (Deckenbefestigung) Allround in motion (ceiling mounting)



SYSTEM

Allround 120 mm ø	Allround 160 mm ø	Allround 240 mm ø	Gehäuse body
LED G 8 Watt, ~2.700k ~920 lm	LED G 12 Watt, ~2.700k ~1.300 lm	LED G 16 Watt, ~2.700k ~1.600 lm	
1 Phase ● 7-2231211 ● 7-2231212 ● 7-2231213 ● 7-2231212-22 ● 7-2231212-02 ● 7-2231212-23	1 Phase ● 7-2231611 ● 7-2231612 ● 7-2231613 ● 7-2231612-22 ● 7-2231612-02 ● 7-2231612-23	1 Phase ● 7-2232411 ● 7-2232412 ● 7-2232413 ● 7-2232412-22 ● 7-2232412-02 ● 7-2232412-23	chrome matt chrome nickel matt white matt/chr. black matt/chr anthracite matt/chr.
3 Phasen ● 7-2241211 ● 7-2241212 ● 7-2241213 ● 7-2241212-22 ● 7-2241212-02 ● 7-2241212-23	3 Phasen ● 7-2241611 ● 7-2241612 ● 7-2241613 ● 7-2241612-22 ● 7-2241612-02 ● 7-2241612-23	3 Phasen ● 7-2242411 ● 7-2242412 ● 7-2242413 ● 7-2242412-22 ● 7-2242412-02 ● 7-2242412-23	chrome matt chrome nickel matt white matt/chr. black matt/chr anthracite matt/chr.

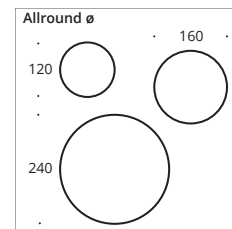

□ Chrom Teile/
chrome parts
■ Gepulverte Teile/
powder-coating

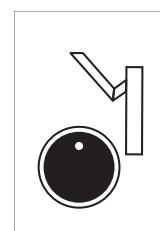
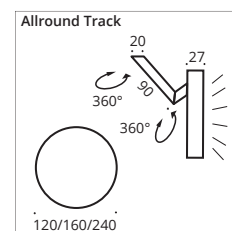

BATH & WELLNESS

1. Spiegelleuchten 352 - 375
2. Lichtspiegel 376 - 419

In den letzten Jahren hat sich das Badezimmer immer mehr zur Wellnessoase entwickelt. Da darf natürlich ein großer, gut ausgeleuchteter Spiegel nicht fehlen. Da die Raumsituationen ebenso verschieden sind, wie die Vorlieben der Menschen, bieten wir eine große Auswahl an Modellen, die mit vielen Extras genau auf Maß gefertigt werden können. Natürlich »Made in Germany«. Kreieren Sie Ihren Traumspiegel mit der optimalen Beleuchtung.

In recent years, the bathroom has increasingly developed into a wellness oasis. Of course, a large, well-lit mirror is an absolute must. As the room situations are as varied as people's preferences, we offer a wide range of models that can be made to measure with many extras. Of course "Made in Germany". Create your dream mirror with the optimal lighting







IP44

Dieses Zeichen finden Sie auf den Seiten unserer Leuchten, die den IP44 Spritzwasserschutz haben.

This symbol indicates that the light has IP protection class IP44.



Schutzbereich für Leuchten und Lichtspiegel

Oft tritt die Frage auf: Welche Schutzklassen gelten im Badezimmer? Wie hoch muss der Schutzgrad der Leuchte sein, die ich im Badezimmer montieren möchte? Um etwas Aufklärung zu schaffen, haben wir auf dieser Doppelseite einmal die verschiedenen Schutzbereiche im Bad aufgezeigt. Die zusätzlichen Erklärungen sollen Ihnen helfen, die richtige Leuchte zu finden.

A frequently asked question is which IP protection class is required. Which class of my lighting fixture is necessary to be allowed to be mounted in the bathroom? To support you with this important question we designed this page which gives you an overview over the different IP protection class sections in bathrooms. The additional explanations should help to find the right lighting fixture.



Wofür braucht man IP44

IP44 steht für Schutz vor Fremdkörpern (>1mm), sowie vor Spritzwasser. Auf unserem Bild sehen Sie, welche Zonen unbedenklich sind und wo man auf ausreichenden IP-Schutz achten sollte.

Zone 1:

Im Bereich der Badewanne und /oder Dusche sind nur Leuchten mit Niedervoltspannung (12V) und hohem Schutzgrad (IP44/IP65 und Höher) zu verwenden, die nur von einem Fachmann installiert werden sollten.

Zone 2:

Oberhalb der Badewanne und /oder der Dusche bzw. daneben und im Abstand von 60 cm oberhalb des Waschbeckens, können alle unsere Badleuchten mit dem Schutzgrad von IP44 montiert werden. Hier können sowohl Niedervolt- als auch Hochvoltleuchten verwendet werden.

Zone 3:

Hier sind in Deutschland alle Leuchten ab einem Schutzgrad von IP20 einsetzbar. Es sollten jedoch Wasserdampf und Spritzwasser, die auf die Leuchten einwirken könnten, vermieden werden. Wenn Sie ganz sicher gehen wollen, verwenden Sie auch hier Leuchten der Schutzklasse IP44.

When IP44 is required

IP44 is made for protection of small parts (>1mm) as well as for splash-water. Our example image shows, which sections are harmless and where IP classes should be taken in consideration.

Zone 1:

Next to the bath tub or shower lights with low voltage and high IP protection class (IP44/IP65 and higher) are mandatory and have to be installed by a professional.

Zone 2:

Above the bath tub or shower or next to it (minimum distance 60cm) all lights with protection class IP44 are adequate. Low voltage lights as well as high voltage lights can be installed.

Zone 3:

In Germany all lights with IP Protection class IP 20 can be installed. Hot steam or splashwater should be avoided. To be safe please use a light with IP protection class IP44.



SPIEGELKLEMMLEUCHTEN

MIRROR LAMPS



Puk Mini Fix 355
Puk Maxx Fix 357



Puk Mini Fix »+« 355
Puk Maxx Fix »+« 357



Puk Mini Mirror 359
Puk Maxx Mirror 361



Puk Mini Mirror »+« 359
Puk Maxx Mirror »+« 361



Puk Mini Flexlight Fix 363

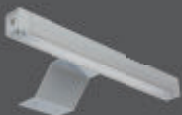

Only Choice Furniture 365



Only Choice Mirror Fix 367



Lichtstange Klemmi 369



Two Socket Fix 371



Flexlight Fix 373



Glass- & Spotlight Fix 375





Puk Mini Fix & Puk Mini Fix »+« Ø 80

Spiegelklemmleuchte, Hochvolt Halogen oder LED Power, dimmbar, Fix »+« Kopf drehbar mit Verstellstift.

Mirror clip lamp, high voltage halogen or LED power, dimmable, rotatable Fix »+« head with adjusting pin.



nickel matt



chrome matt

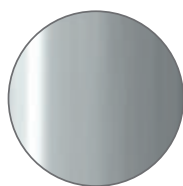

chrome

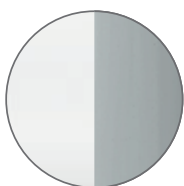

white matt/
chrome

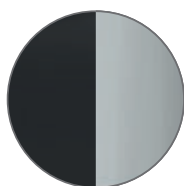

black matt/
chrome

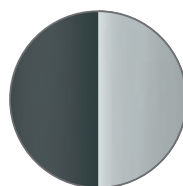

anthracite matt/
chrome

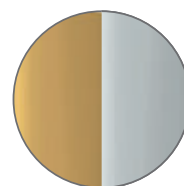

24c gold/
chrome

Puk Mini Fix LED G 2 x 8W ~1.200lm ~2.700k	Puk Mini Fix G9 Fassung 	Länge ab Spiegel mm length from mirror mm	Puk Mini Fix »+« LED G 2 x 8W ~1.200lm ~2.700k	Puk Fix »+« G9 Fassung 	Länge ab Spiegel mm length from mirror mm	Gehäuse body
2-08011-LED	2-08011	90	2-08031-LED	2-08031	100	chrome matt
2-08012-LED	2-08012	90	2-08032-LED	2-08032	100	chrome
2-08013-LED	2-08013	90	2-08033-LED	2-08033	100	nickel matt
2-08012-LED-22	2-08012-22	90	2-08032-LED-22	2-08032-22	100	white matt/chrome
2-08012-LED-02	2-08012-02	90	2-08032-LED-02	2-08032-02	100	black matt/chrome
2-08012-LED-23	2-08012-23	90	2-08032-LED-23	2-08032-23	100	anthracite/chr.
2-08016-LED	2-08016	90	2-08036	2-08036	100	24 carat gold plated/chr.

▶ Ohne Zubehör. Bestell-Artikelnummern für Linse, Glas, Farbfilter und die Konfigurationsempfehlung auf der Einklappseite!

▶ Without accessories: Order item-no. for lens, glass, color filter and the recommended Configuration are on the fold-in page!

Leuchtmittelangabe: LED **G** inkl. | G9 max. 33W ECO, optional LED Retrofit

bulb information: LED **G** incl. | G9 max. 33W ECO, LED Retrofit optional

Leuchtmittelempfehlung: LED max. 3W/300lm/2.700K/dimmbar **G** Art Nr. 8-205

bulb recommendation: LED max. 3W/300Lm/2.700K/dimmable **G** Item No. 8-205

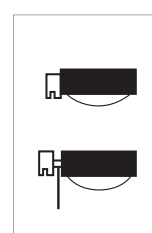
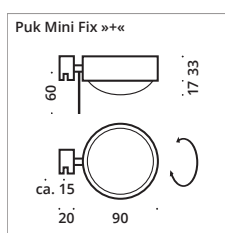
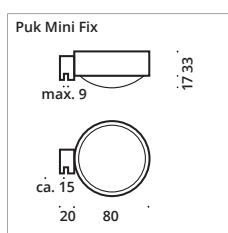

Chrom Teile/
chrome parts
 Gepulverte Teile/
powder-coating





Puk Maxx Fix & Fix »+« Ø 120

Spiegelanbauleuchte, Hochvolt Halogen oder LED Power, dimmbar, bei der »+« Variante Kopf drehbar mit Verstellstift.

Mirror mounting lamp, high voltage halogen or LED power, dimmable, Fix »+« model with rotatable head and adjusting pin.



chrome matt



nickel matt

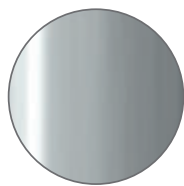

chrome

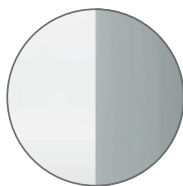

white matt/
chrome

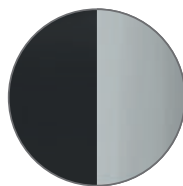

black matt/
chrome

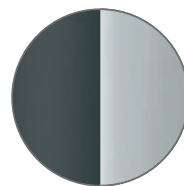

anthracite matt/
chrome

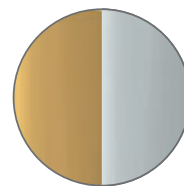

24c gold/
chrome

Puk Maxx Fix LED G 2 x 12W ~1.800lm ~2.700k	Spiegelabstand x Höhe mm mirrorspace x height mm	Puk Maxx Fix »+« LED G 2 x 12W ~1.800lm ~2.700k	Puk Maxx Fix »+« G9 Fassung	Spiegelabstand x Höhe mm mirrorspace x height mm	Gehäuse body
● 2-308011	130 x 50	2-308031	2-308031-H	140 x 50	chrome matt
● 2-308012	130 x 50	2-308032	2-308032-H	140 x 50	chrome
● 2-308013	130 x 50	2-308033	2-308033-H	140 x 50	nickel matt
● 2-308012-22	130 x 50	2-308032-22	2-308032-H-22	140 x 50	white matt/chrome
● 2-308012-02	130 x 50	2-308032-02	2-308032-H-02	140 x 50	black matt/chrome
● 2-308012-23	130 x 50	2-308032-23	2-308032-H-23	140 x 50	anthracite matt/chrome
● 2-308016	130 x 50	2-308036	2-308036-H	140 x 50	24 ct gold plated/chrome

► Ohne Zubehör. Bestell-Artikelnummern für Linse, Glas, Farbfilter und die Konfigurationsempfehlung auf der Einklappseite!

► Without accessories: Order item-no. for lens, glass, color filter and the recommended Configuration are on the fold-in page!



Leuchtmittelangabe: LED **G** inkl. | G9 max. 33W ECO, optional LED Retrofit

bulb information: LED **G** incl. | G9 max. 33W ECO, LED Retrofit optional

Leuchtmittlempfehlung: LED max. 3W/300lm/2.700K/dimmbar **G** Art Nr. 8-205

bulb recommendation: LED max. 3W/300Lm/2.700K/dimmable **G** Item No. 8-205

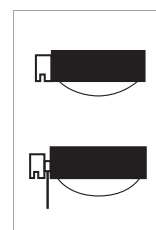
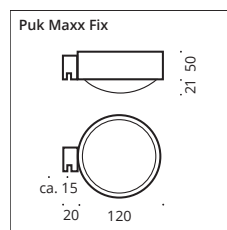
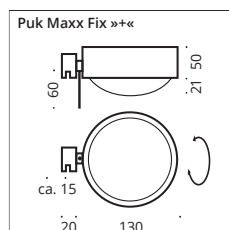

□ Chrom Teile/
chrome parts
■ Gepulverte Teile/
powder-coating





Puk Mini Mirror & Puk Mini Mirror »+« Ø 80

Spiegelaufbauleuchte, Hochvolt Halogen oder LED Power, dimmbar, Mirror »+« Kopf drehbar mit Verstellstift.

Mirror mounting lamp, high voltage halogen or LED power, dimmable, Mirror »+« head rotatable with adjusting pin.

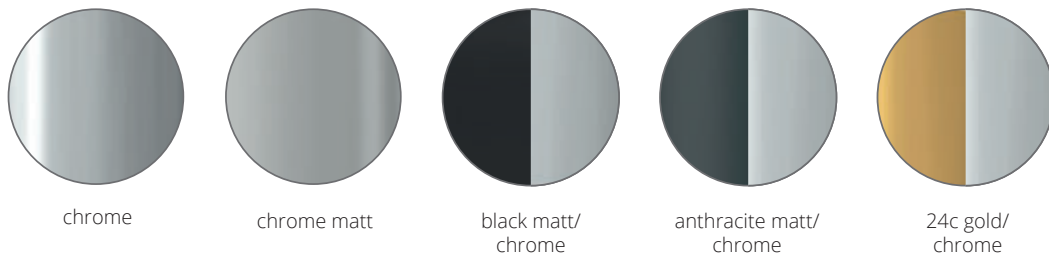

Puk Mirror LED G 2 x 8W ~1.200lm ~2.700k	Puk Mirror G9 Fassung	Länge ab Spiegel mm length from mirror mm	Puk Mirror »+« LED G 2 x 8W ~1.200lm ~2.700k	Puk Mirror »+« G9 Fassung	Länge ab Spiegel mm length from mirror mm	Gehäuse body
● 2-08211-LED	2-08211	80	● 2-08411-LED	2-08411	90	chrome matt
● 2-08212-LED	2-08212	80	● 2-08412-LED	2-08412	90	chrome
● 2-08213-LED	2-08213	80	● 2-08413-LED	2-08413	90	nickel matt
● 2-08212-LED-22	2-08212-22	80	● 2-08412-LED-22	2-08412-22	90	white matt/chrome
● 2-08212-LED-02	2-08212-02	80	● 2-08412-LED-02	2-08412-02	90	black matt/chrome
● 2-08212-LED-23	2-08212-23	80	● 2-08412-LED-23	2-08412-23	90	anthracite matt/chrome
● 2-08216-LED	2-08216	80	● 2-08416-LED	2-08416	90	24 carat gold plated/chr.

► Ohne Zubehör. Bestell-Artikelnummern für Linse, Glas, Farbfilter und die Konfigurationsempfehlung auf der Einklappseite!
 ► Without accessories: Order item-no. for lens, glass, color filter and the recommended Configuration are on the fold-in page!



Leuchtmittelangabe: LED **G** inkl. | G9 max. 33W ECO, optional LED Retrofit
 bulb information: LED **G** incl. | G9 max. 33W ECO, LED Retrofit optional

Leuchtmittelempfehlung: LED max. 3W/300lm/2.700K/dimmbar **G** Art Nr. 8-205
 bulb recommendation: LED max. 3W/300lm/2.700K/dimmable **G** Item No. 8-205

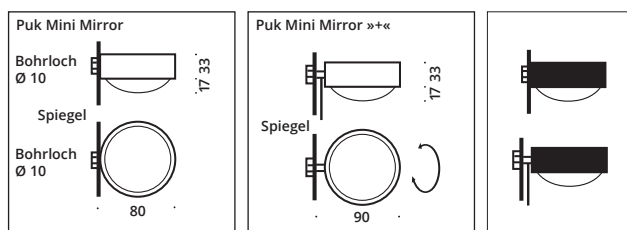

□ Chrom Teile/
chrome parts
■ Gepulverte Teile/
powder-coating

BATH & WELLNESS





Puk Maxx Mirror & Mirror »+« Ø 120

Spiegeleinbauleuchte, Hochvolt Halogen oder LED Power, dimmbar, bei der »+« Variante Kopf drehbar mit Verstellstift.

Mirror mounting lamp, high voltage halogen or LED power, dimmable, »+« model head rotatable with adjusting pin.

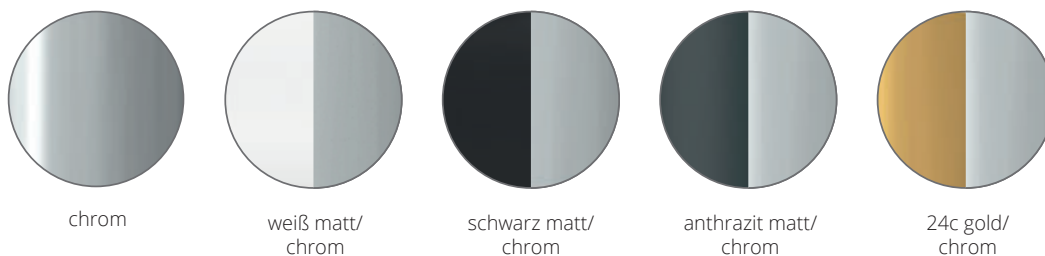

Puk Maxx Mirror LED G 2 x 12W ~1.800lm ~2.700k	Puk Maxx Mirror »+« LED G 2 x 12W ~1.800lm ~2.700k	Puk Maxx Mirror »+« G9 Fassung	Spiegelabstand x Höhe mm mirrorspace x height mm	Gehäuse body
2-308211	2-308411	2-308411-H	120/130/145 x 50	chrome matt
2-308212	2-308412	2-308412-H	120/130/145 x 50	chrome
2-308213	2-308413	2-308413-H	120/130/145 x 50	nickel matt
2-308212-22	2-308412-22	2-308412-H-22	120/130/145 x 50	white matt/chrome
2-308212-02	2-308412-02	2-308412-H-02	120/130/145 x 50	black matt/chrome
2-308212-23	2-308412-23	2-308412-H-23	120/130/145 x 50	anthracite matt/chrome
2-308216	2-308416	2-308416-H	120/130/145 x 50	24 ct gold plated/chrome

► Ohne Zubehör. Bestell-Artikelnummern für Linse, Glas, Farbfilter und die Konfigurationsempfehlung auf der Einklappseite!

► Without accessories: Order item-no. for lens, glass, color filter and the recommended Configuration are on the fold-in page!

Leuchtmittelangabe: LED **G** inkl. | G9 max. 33W ECO, optional LED Retrofit

bulb information: LED **G** incl. | G9 max. 33W ECO, LED Retrofit optional

Leuchtmittelempfehlung: LED max. 3W/300lm/2.700K/dimmbar **G** Art Nr. 8-205

bulb recommendation: LED max. 3W/300Lm/2.700K/dimmable **G** Item No. 8-205

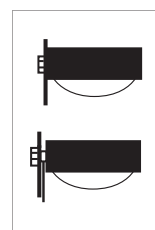
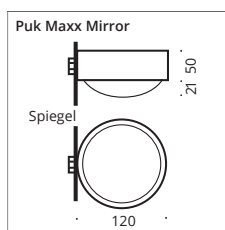
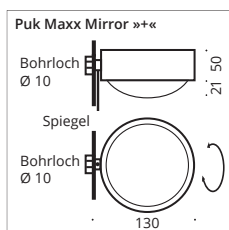

Chrom Teile/
chrome parts
 Gepulverte Teile/
powder-coating





Puk Mini Flexlight Fix \varnothing 80

Puk Mini Spiegelleuchte in Halogen oder LED mit Flexarm und Fixhalterung zur Anbringung an den Spiegel. Gläser/Linsen und Farbfilter werden separat dazubestellt.

Halogen or LED Puk Mini mirror luminaire with flex arm and fixed mount for attaching to the mirror. Glasses/lenses and colour filters are sold separately.



nickel matt

chrome

BATH & WELLNESS

Puk Flexlight Fix LED G 2 x 8W, ~1.200lm ~2.700k	Puk Flexlight Fix G9 Fassung	Armlänge arm length in mm	Gehäuse body
3-2020114-LED	3-2020114	200	chrome
3-2020214-LED	3-2020214	200	nickel matt
3-2030114-LED	3-2030114	300	chrome
3-2030214-LED	3-2030214	300	nickel matt

▶ Ohne Zubehör. Bestell-Artikelnummern für Linse, Glas, Farbfilter und die Konfigurationsempfehlung auf der Einklappeseite!

▶ Without accessories: Order item-no. for lens, glass, color filter and the recommended Configuration are on the fold-in page!



G9 max. 33W, optional LED Retrofit
G9 max. 33W, LED Retrofit optional

Leuchtmittelempfehlung: LED max. 3W/300lm/2.700K/dimmbar **G** Art Nr. 8-205
bulb recommendation: LED max. 3W/300Lm/2.700K/dimmable **G** Item No. 8-205

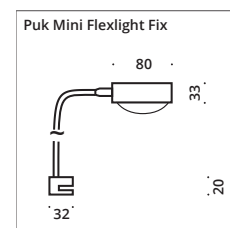





Only Choice Furniture

LED Aufsatzleuchte für Badezimmer- und Kosmetikschränke, Regale oder Kleiderschränke. Schraub- oder klebbar. Die Leuchte ist über ein Gelenk schwenkbar. Anfertigung auf Maß für gleiche Spiegel- oder Schrankbreite möglich. Zuleitung mit Kabel und Stecker für die Steckdose.



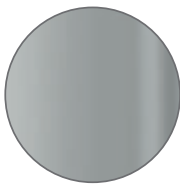

LED attachment light for bathroom and cosmetic cabinets, shelves or wardrobes. Can be screwed or bonded. The luminaire can be swivelled via a joint. Made to measure for the same mirror or cabinet width on request. Feeder with cable and plug for the power socket.

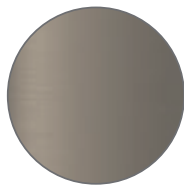

chrome matt



nickel matt

350 mm L	600 mm L	800 mm L	1.250 mm L	Gehäuse body
LED  9W, ~720lm, ~3.000k	LED  13,5W, ~1080lm, ~3.000k	LED  22,5W, ~1800lm, ~3.000k	LED  36W, ~2880lm, ~3.000k	
● 8-60301	8-60601	8-60901	8-601201	chrome matt
● 8-60302	8-60602	8-60902	8-601202	chrome
● 8-60303	8-60603	8-60903	8-601203	nickel matt

Farbig gepulverter Lichtbalken auf Anfrage. Color powdered metal rail on request.



C (s.S 6-7/s.p. 6-7)

Sonderanfertigung:

Art-Nr. 8-600 Kürzung auf Maß

Item No. 8-600 Customized lengths

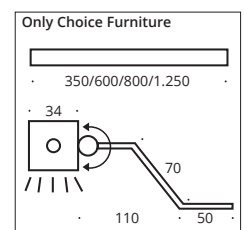





Only Choice Mirror Fix

LED Spiegelklemmleuchte mit Hochleistungsdiffusor für brilliantes Ausleuchten des Betrachters. Über ein Gelenk ist die Leuchte dem Betrachter zuschwenkbar. Anfertigung auf Maß für gleiche Spiegel- oder Schrankbreite optional. Zuleitung mit Kabel und Stecker für die Steckdose.

LED mirror clip-on luminaire with high-performance dif-fuser for brilliant illumination of the observer. The luminaire can be swivelled towards the observer via a joint. Made to measure for the same mirror or cabinet width on request. Feeder with cable and plug for the power socket.

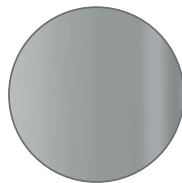

chrome matt

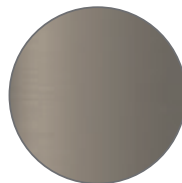

nickel matt

350 mm L	600 mm L	800 mm L	1.250 mm L	Gehäuse body
LED G 9W, ~720lm, ~3.000k	LED G 13,5W, ~1080lm, ~3.000k	LED G 22,5W, ~1800lm, ~3.000k	LED G 36W, ~2880lm, ~3.000k	
● 8-61301	8-61601	8-61901	8-611201	chrome matt
● 8-61302	8-61602	8-61902	8-611202	chrome
● 8-61303	8-61603	8-61903	8-611203	nickel matt

Farbig gepulverter Lichtbalken auf Anfrage. Color powdered metal rail on request.



C (s.S 6-7/s.p. 6-7)

Sonderanfertigung:

Art-Nr. 8-600 Kürzung auf Maß

Item No. 8-600 Customized lengths

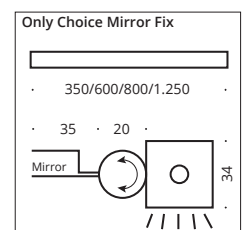

BATH & WELLNESS



Lichtstange Klemmi



Lichtstange Klemmi

Erhältlich als Wandleuchte, mit LED-Röhre 1-sockelig in opal, optional mit Kippschalter, Wandabstand 70 mm. Als Lichtstange mit Klemmbefestigung zur Montage am Spiegel, mit transparentem Kabel, Schalter und Stecker, Leuchtmittel LED (8W).

Available as wall lamp with LED tube 1-socket in opal. Optionally with flip switch. Wall distance 70 mm. As light light-bar with clip for mounting on mirror, with cable transparent, switch and plug, illuminant LED (8W).

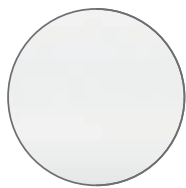

white matt

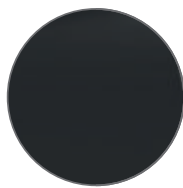

black matt

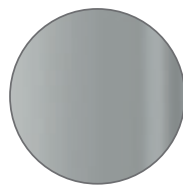

chrome matt

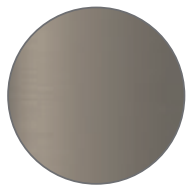

nickel matt

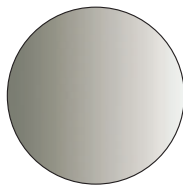

Nickelvelours,
nickel suede

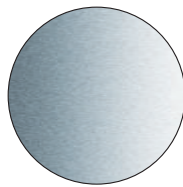

Alumattstruktur,
alum. matt structure

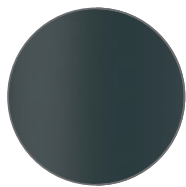

anthracite matt



Optional mit integriertem Schalter
optionally with integrated switch
chrome

Modell model	LED ohne Leuchtmittel without lamp	LED 8W ~700lm, ~2.700k	Ausführung design
● Lichtstange	2-0312	2-0312-LED	chrome
● Klemmi	2-0312-22	2-0312-LED-22	white matt
● Spiegelstärke	2-0312-02	2-0312-LED-02	black matt
● mirror thickness	2-0311	2-0311-LED	chrome matt
● 3-9 mm	2-0319	2-0319-LED	nickel matt
	2-0313	2-0313-LED	nickel suede
	2-0314	2-0314-LED	alum. matt texture
	2-0312-23	2-0312-LED-23	anthracite matt



Für einen integr. Schalter hängen Sie bitte ein -K hinter die Art.-Nr.
Please attach -K behind the item-no. for an integrated switch.

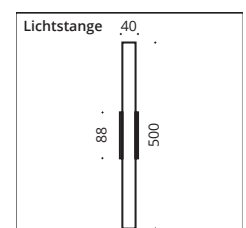





Two Socket

Gerade richtig ist die extra lange Spiegelklemmleuchte für den Spiegeleinsatz.

Just right is this extra long mirror lamp for mirror use.

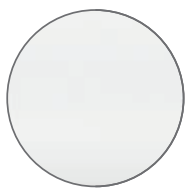

white matt

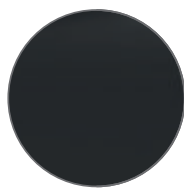

black matt

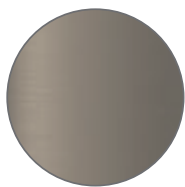

nickel matt

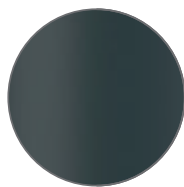

anthracite matt



Two Socket Fix chrome



Two Socket Base Fix chrome

Modell model	LED ohne Leuchtmittel without lamp	LED G 16W, ~1.450lm, ~3.000k	Ausführung design	Beschreibung specification
● Two Socket	2-0412	2-0412-LED	chrome	Two Socket mit Klemmbefestigung zur Montage am Spiegel, 2-sockelig, max. 120 Watt Two Socket with clip mounting piece for mirror mounting, 2 bases, max.120 watts
● Fix	2-0419	2-0419-LED	nickel matt	
● Spiegelstärke	2-0412-22	2-0412-LED-22	white matt	
● mirror thickness	2-0412-02	2-0412-LED-02	black matt	
● 3-9 mm	2-0412-23	2-0412-LED-23	anthracite matt	
● Two Socket	2-0432	2-0432-LED	chrome	Two Socket mit Grundplatte und Klemmbefestigung zur Montage am Spiegel, 2-sockelig, max. 120 Watt Two Socket with clip mounting piece for mirror mounting, 2 bases, max.120 watts
● Base Fix	2-0439	2-0439-LED	nickel matt	
● Spiegelstärke	2-0432-22	2-0432-LED-22	white matt	
● mirror thickness	2-0432-02	2-0432-LED-02	black matt	
● 3-9 mm	2-0432-23	2-0432-LED-23	anthracite matt	

Für einen integr. Schalter hängen Sie bitte ein -K hinter die Art.-Nr.

Please attach -K behind the item-no. for an integrated switch.

Two Socket: Two Socket Base: C (s.S 6-7/s.p. 6-7)

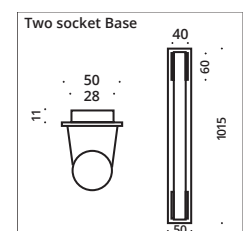





Flexlight Fix



Iglo	India	Pisa	Silk	Rio	Armlänge arm length in mm	Ausführung design
G9 ohne Leuchtmittel without lamp	G9 ohne Leuchtmittel without lamp	G9 ohne Leuchtmittel without lamp	E14 ohne Leuchtmittel without lamp	GU10 ohne Leuchtmittel without lamp		
3-2020101	3-2020102	3-2020103	3-2020105	3-2020117	200	chrome
3-2020201	3-2020202	3-2020203	3-2020205	3-2020217	200	nickel matt
3-2030101	3-2030102	3-2030103	3-2030105	3-2030117	300	chrome
3-2030201	3-2030202	3-2030203	3-2030205	3-2030217	300	nickel matt
3-2040101	3-2040102	3-2040103	3-2040105	3-2040117	400	chrome
3-2040201	3-2040202	3-2040203	3-2040205	3-2040217	400	nickel matt

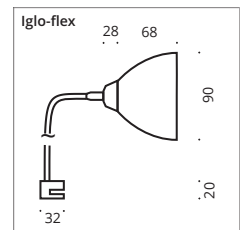

C (s.S 6-7/s.p. 6-7)

G9 max. 33W ECO, optional LED Retrofit G9 max. 33W ECO, LED Retrofit optional	Leuchtmittlempfehlung: LED max. 3W/300lm/2.700K/dimmbar bulb recommendation: LED max. 3W/300Lm/2.700K/dimmable	Art. Nr. 8-205 Item No. 8-205
E14 max. 20W, optional LED Retrofit E14 max. 20W, LED Retrofit optional	Leuchtmittlempfehlung: LED max. 6W/470lm/2.700K bulb recommendation: LED max. 6W/470Lm/2.700K	Art. Nr. 8-524 Item No. 8-524
GU10 max. 35W, optional LED Retrofit GU10 max. 35W, LED Retrofit optional	Leuchtmittlempfehlung: LED max. 4W/230lm/2.700K bulb recommendation: LED max. 4W/230Lm/2.700K	Art. Nr. 8-211 Item No. 8-211

Umbau zum Spiegeleinbau, conversion for mirror mounting
 180° Reflektor optional für Glas Pisa, 180° baffle optional for glass Pisa
 Weitere Schirm-Farben für die Silk finden Sie auf der Einklappseite. You can find more colors for the silk shades on page the fold-in page.

Art.-Nr. 9-3002 chrom (chrome), Art.-Nr. 9-3009 nickelmatt (nickel matt)
 Art.-Nr. 9-204





Glass- & Spotlight Fix



Iglo



Pisa



Pisa Double IP44



India



Rio



Pisa Double



Bulb

Iglo G9 ohne Leuchtmittel without lamp	India G9 ohne Leuchtmittel without lamp	Pisa G9 ohne Leuchtmittel without lamp	Rio GU10 Leuchtmittel without lamp	Ausführung design
2-200101 2-200201	2-200102 2-200202	2-200103 2-200203	2-200117 2-200217	chrome nickel matt

C (s.S 6-7/s.p. 6-7)

Pisa Double G9 ohne Leuchtmittel without lamp	Pisa Double IP44 G9 ohne Leuchtmittel without lamp	Bulb G9 ohne Leuchtmittel without lamp	Ausführung design
2-200130 2-200230	2-200130 IP44 2-200230 IP44	2-200132 2-200232	chrome nickel matt

C (s.S 6-7/s.p. 6-7)

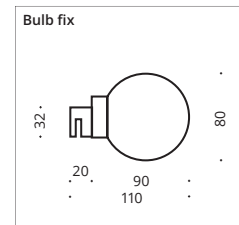
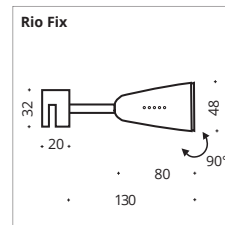

G9 max. 33W ECO, optional LED Retrofit
 G9 max. 33W ECO, LED Retrofit optional

Leuchtmittlempfehlung: LED max. 3W/300lm/2.700K/dimmbar Art Nr. 8-205
 bulb recommendation: LED max. 3W/300Lm/2.700K/dimmable Item No. 8-205

GU10 max. 35W, optional LED Retrofit
 GU10 max. 35W, LED Retrofit optional

Leuchtmittlempfehlung: LED max. 4W/230lm/2.700K
 bulb recommendation: LED max. 4W/230Lm/2.700K Art. Nr. 8-211
 Item No. 8-211

Umbau zum Spiegeleinbau, conversion for mirror mounting

Art.-Nr. 9-3002 chrom (chrome), 9-3009 nickelmatt (nickel matt)

180° Reflektor optional für Glas Pisa, 180° baffle optional for glass Pisa Art.-Nr. 9-204



LICHTSPIEGEL

ILLUMINATED MIRRORS



Mirror Light 391



Lumen Light 393



Palace Light 395



Castle Light 397



Visagist 399



FineLine 401



SideLight 403



DotLight 405



BrightLight 407



InLight 409



BulbLine 411 - 413



Circle 415



Vision 417

Typisch Top Light

Quintessentially Top Light

Technologie

Schattenfreie Ausleuchtung des Betrachters. Kinn-, Hals- und Nasenbereich erhalten ihre optimale Ausleuchtung.

Technology

Shadow-free illumination of the viewer. Chin-, neck- and nose-area are illuminated ideally.

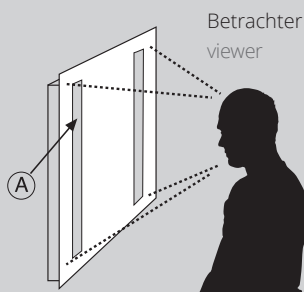

Das Licht

Blendfreie Beleuchtung durch hightech Diffusoren und Reflektoren in: Halogen, Leuchtstoff, LED high Power.

The Light

Anti-glare illumination through high tech diffusers and baffles in: halogen, fluorescent lamps, LED high power.

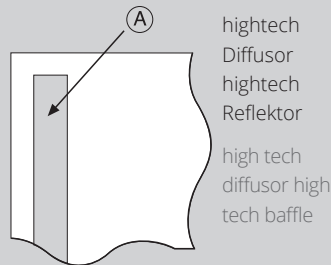

Der Spiegel

Fertigung nach deutscher Spiegelnorm. 12 Schichtverfahren, Kristall Float Glas und eine Reflektionsschicht aus reinem Silber sorgen für eine dauerhafte Tonwiedergabe.

The Mirror

Manufacturing according to German mirror standard. 12 layer proceedings, crystal float glass and a reflective layer made of pure silver provide a durable reproduction.

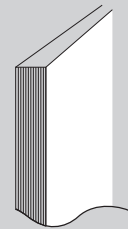

Lichtspiegel Extras Illuminated mirror extras

Facette 20 mm, Facet 20 mm

Einbausteckdose, Flush mounting socket

Einbauschalter, Flush mounting switch

Schalter mittig verdeckt, Switch with central cover

Dimmer mit Taster und Memory, Dimmer with pushbutton and memory

Drehdimmer für Leuchtstoff T5, Rotating dimmer for fluorescent lamp T5

Aluabblendeleiste, Aluminium cover strip

Klappspiegel, Folding mirror

Raumteilerausbildung, Room divider

Spiegelheizung, Mirror heating

Smarthome »Casambi« integriert, Smarthome »Casambi« integrated

UV verklebte Glasablage, UV bonded glass shelf

Gesten- oder Berührungssteuerung, Gesture or Touch Control





Lichtspiegel — Fertigung auch auf Wunschmaß!

Illuminated mirrors — Manufactured to any dimension!

Eine außergewöhnliche und umfangreiche Spiegelkollektion der besonderen Art die keinen Wunsch mehr offen lässt. Die Kristallspiegel sind satiniert, die Kanten geschliffen und poliert. Die Fertigung erfolgt nach deutscher Spiegelnorm.

A very exceptional and extensive collection of mirrors that makes all your wishes come true. The crystal mirrors are glazed, the edges are smoothed and polished. We manufacture according to German mirror standards.

- ▶ Anfertigung nach Maß
- ▶ LED (Farbtemperatur: ~3.000 Kelvin warmweiß*, Farbwiedergabewert: ~95 CRI)
- ▶ Auf Wunsch ist auch die Ausstattung mit 4.000 Kelvin LED möglich
- ▶ IP 44 spritzwassergeschützt (auf Wunsch)
- ▶ ca. 25 mm Wandabstand
- ▶ 6 mm Kristallspiegel (hergestellt nach deutscher Spiegelnorm)
- ▶ auf Wunsch Smarthome »Casambi« integrierbar
- ▶ optional mit Gesten- oder Berührungssteuerung

*je nach Ausführung / gemessen ohne Satinierung

- ▶ Made to measure
- ▶ LED (color temperature: ~3.000 Kelvin warm white*, color reproduction value: ~95 CRI)
- ▶ On request 4.000 Kelvin LED is possible
- ▶ Ip 44 Splash proof (optional)
- ▶ about 25 mm Wall spacing
- ▶ 6 mm crystal mirror (german mirror standards)
- ▶ Smarthome »Casambi« integratable (optional)
- ▶ Gesture or Touch Control (optional)

*depending on version / measured without frosting

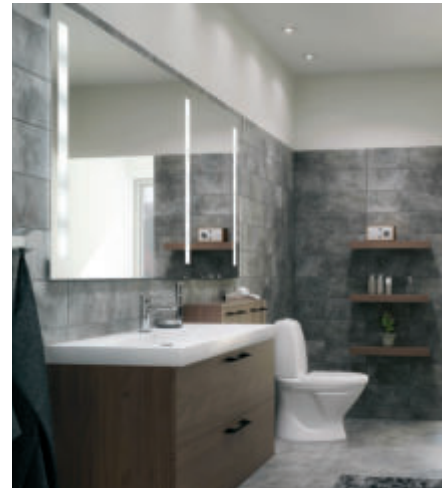

Doppelwaschtisch FineLine



Castle Light



Neues Rahmenprofil kantenbündig



Neues Rahmenprofil eingerückt

Neues Rahmenprofil für Spiegel

Das neue Rahmenprofil wurde speziell für den Einsatz der LED Technik entwickelt. Die LED Module lassen sich bei Bedarf schnell austauschen und stellen somit einen professionellen Service vor Ort sicher. Die verarbeiteten LED haben mit 3.000 Kelvin und einem Farbwiedergabewert von ca. 95 CRI eine optimale Ausleuchtung - perfekt für den gewerblichen Bereich!

New mirror frame profile

The new frame profile was developed specifically for LED technic applications. The LED modules can be changed easily and provide a professional service. 3.000k and about 95 CRI ensure an optimum of illumination. Perfect for the commercial sector!

Gestensteuerung

Nur eine Bewegung entfernt vom perfekten Licht



Die Preise errechnen sich aus den Spiegellistenpreisen zzgl. dem Preis für die gewünschte Gestensteuerungs-Variante.

1. Dimmen und Schalten mit Memoryfunktion
 - An- und Ausschalten
 - stufenloses DimmenArt.-Nr. 1-00119
2. Dimmen, Schalten und stufenlose Änderung der Farbtemperatur von 2.600K bis 5.400K (Tuneable White) mit Memoryfunktion
 - An- und Ausschalten
 - stufenloses Dimmen
 - stufenloser FarbtemperaturwechselArt.-Nr. 1-00107

Gesture Control

Form the mirror you desire

The prices are calculated from the mirror pricelist plus the price for the desired mirror control version:

1. Dim and switch including memory function
 - On/Off
 - dimmingArt.-Nr. 1-00119
2. Dim, switch and color changing from 2,600K bis 5,400K (Tuneable White) including memory function
 - On/Off
 - dimming
 - changing the color temperatureArt.-Nr. 1-00107

GESTENSTEUERUNG/GESTURE CONTROL:

A → C: An/Aus On/Off A ← C: An/Aus On/Off

A → B → Halten/Hold: Dimmen/Dim

C → B → Halten/Hold: Dimmen/Dim

A → C → B → Halten/Hold: Farbtemperatur/
Color Temperature (Tuneable White)

C → A → B → Halten/Hold: Farbtemperatur/
Color Temperature (Tuneable White)

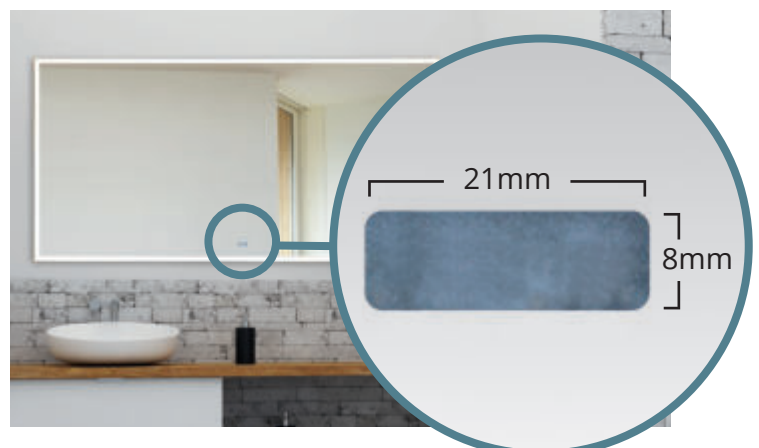



Berührungssteuerung

Nur eine Berührung entfernt vom perfekten Licht

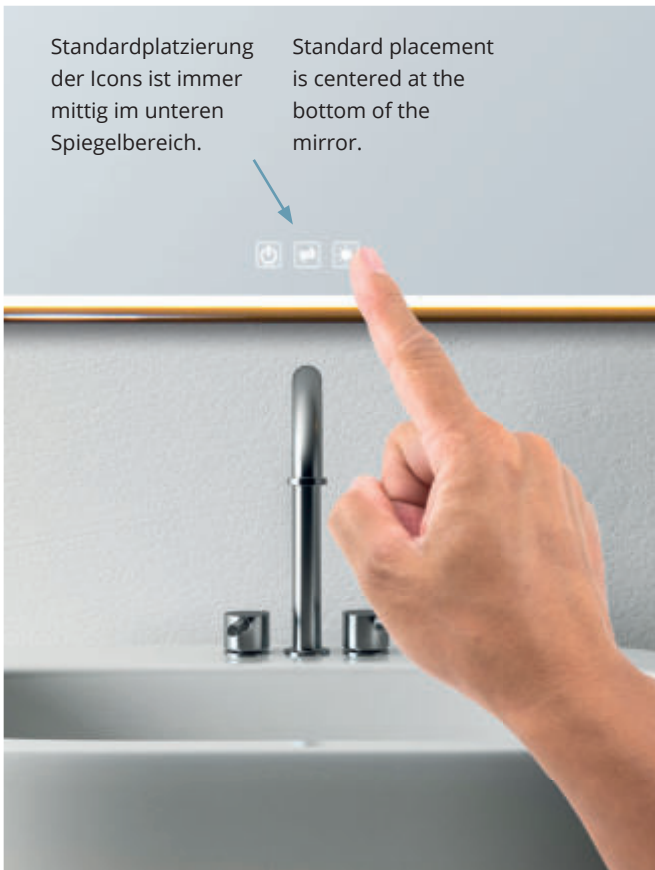

Die Preise errechnen sich aus den Spiegellistenpreisen zzgl. dem Preis für die gewünschte Spiegelsteuerungs-Variante:

1. Dimmen und Schalten mit Memoryfunktion
 - An- und Ausschalten
 - stufenloses Dimmen
 Art.-Nr. 1-00125
2. Dimmen, Schalten und stufenlose Änderung der Farbtemperatur von 2.600K bis 5.400K mit Memoryfunktion
 - An- und Ausschalten
 - stufenloses und schrittweises Dimmen
 - schrittweiser und stufenloser Farbtemperaturwechsel
 Art.-Nr. 1-00126

Touch Control

Form the mirror you desire

The prices are calculated from the mirror pricelist plus the price for the desired mirror control version:











1. Dim and switch including memory function
 - On/Off
 - stepless dimming
 Art.-Nr. 1-00125
2. Dim, switch and color changing from 2,600K bis 5,400K including memory function
 - On/Off
 - dimming stepless and step by step
 - changing the color temperature stepless and step by step
 Art.-Nr. 1-00126

BERÜHRUNGSSTEUERUNG/ TOUCH CONTROL:

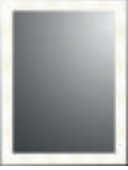
1. An/Aus: kurze Berührung
On/Off: brief Touch
- Dimmen: lange Berührung (5%-100%)
Dim: extended Touch (5%-100%)
2. An/Aus: kurze Berührung
On/Off: brief Touch
- Dimmen: kurze Berührung (5, 30, 60, 100%)
Dim: brief Touch (5, 30, 60, 100%)
- Dimmen: lange Berührung (5%-100%)
Dim: extended Touch (5%-100%)
- Farbtemperatur: kurze Berührung (schrittweise)
Color Temperature: brief Touch (step by step)
- Farbtemperatur: lange Berührung (stufenlos)
Color Temperature: extended Touch (stepless)

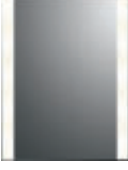

Konfigurationsdokumentation Configuration documentation

Bild picture	Name name	Design design	Bild picture	Name name	Design design
	Visagist s. Seite 399 s. page 399	Blockmuster inkl. Prismenabdeckung, seitlich abnehmbar Block pattern design incl. prism cover removable on the side		Mirror Light s. Seite 391 s. page 391	rundum beleuchteter Acryl-Rahmen all-round illuminated acrylic frame
	FineLine s. Seite 401 s. page 401	Linienmuster inkl. Prismenabdeckung, seitlich abnehmbar Lined pattern design incl. prism cover removable on the side		Lumen Light s. Seite 393 s. page 393	rundum beleuchteter Alu-Rahmen all-round illuminated aluminium frame
	SideLight s. Seite 403 s. page 403	umlaufende Linie, rundum satiniert framing line, stained all around		Palace Light s. Seite 395 s. page 395	rundum beleuchteter Alu-Rahmen all-round illuminated aluminium frame
	DotLight s. Seite 405 s. page 405	Punktmuster inkl. Prismenabdeckung, seitlich abnehmbar Dotted pattern design incl. prism cover removable on the side		Castle Light s. Seite 397 s. page 397	rundum beleuchteter Alu-Rahmen all-round illuminated aluminium frame
	BrightLight s. Seite 407 s. page 407	Linienmuster, rechts und links außen satiniert Lined pattern design stained outwards on the left and right side		BulbLine s. Seite 413 s. page 413	Lichtkugeln opal, incl. seitl. Aluabdeckung Light bulbs opal, including lateral aluminium cover
	InLight s. Seite 409 s. page 409	indirekter, seitl. Lichtaustritt Indirect lateral light emission	seitl. Aluabdeckung bei BulbLine Aluminium side cover for BulbLine LED Rahmenprofil LED frame profile		



Circle

runder Spiegel mit umlaufendem Muster
round mirror with framing pattern

VisaCircle



DotCircle



SideCircle



FineCircle





Spiegel ohne Beleuchtung - Bearbeitungszuschläge

Mirrors without Illumination - Processing surcharges

Formen / Art. Nr. shapes / item no.	Beispiele, examples
Eckabschnitte beliebige Anzahl any number of corner cuts possible 0-0400	
Abrundungen beliebige Anzahl any number of roundings possible 0-0500	

Veredelungen für Spiegel **ohne Beleuchtung!** Dressing for mirrors **without illumination!**

Facettenschliff Facetted cut 20 mm umlaufend, all round 0-0619	
Extra Bohrloch extra borehole 8 - 65 mm 0-07865	
65 - 100 mm 0-0765100	

Sonderrahmen, Aussparungen,
spezielle Kantenbearbeitung. Holz, Alu-
minium etc. und Sonderanfertigungen
jeder Art!

Special framings, cut-outs, special edge
processing. Wood, aluminium etc. and
custom designs of all kinds!

Lichtspiegel Modifikation – Preisfindung

Illuminated Mirrors – Processing surcharges

	Modell / Art. Nr. model / item no.	Beschreibung	description
	Facette facet 1-00190	Veredelung: 20 mm umlaufend gemessen, Restkante geschliffen	dressing: 20 mm framing, rest of edge smoothed
	Dachschrägenausführung Pitched roof version 1-00100	Formabänderung: Spiegelabschnitt ohne beleuchte- ter Schräge, beliebige Anzahl	dimensional change: mirror cutting without illuminated slant, any number
	Dachschrägenausführung Pitched roof version 1-00101	Formabänderung: Spiegelabschnitt mit beleuchte- ter Schräge, beliebige Anzahl	dimensional change: mirror cutting with illuminated slant, any number
	Spiegel mit Bogen mirror with arch 1-00102 1-00105	Formabänderung: ohne Beleuchtung mit Beleuchtung	dimensional change: arch design without illumination arch design with illumination
	Blendschutzprofil Anti-glare profile 1-00110	aus eloxiertem Aluminium, pro Stück (abnehmbares Magnetband)	made of anodized aluminium, per piece (removable magnetic tape)
	Prismenabdeckung prism cover 1-00114	aus PMMA Kunststoff, pro Stück (gesteckt)	made of PMMA plastic, per piece (inserted)
	Klappspiegel einseitig Folding mirror, one-way 1-00113	Breite max. 40 cm, Höhe wie Spiegel bis 100 cm (andere Größen auf Anfrage), Klappteil ist beidseitig verspiegelt!	width max 40 cm, height like mirrors up to 100 cm (other sizes available on request). Folding parts are mirrored on both sides.
	Kippspiegelhalterung tilting mirror attachment SP-145	Kippspiegelhalterung: Behindertengerecht, 35° nach vorne neigbar	tilting mirror attachment: handicapped accessible, forward tilting angle 35°
	Extra Leuchtfeld (satiniert) Extra light field (satin finish) 1-020000	Zusätzliche Sonderanfertigung: (z.B.: beim Doppelwaschtisch)	additional custom-made option (e.g. with the double washbasin.)
	Extra Leuchtstelle Bulbline extra light source Bulbline 2-0501	Opalglasausführung, 60 mm Kugel, 20W G9, incl. Bohrloch ($\varnothing = 24$ mm)	Opal glass design, 60 mm bulb, 20W G9, incl. borehole ($\varnothing = 24$ mm)



Lichtspiegel Modifikation – Preisfindung

Illuminated Mirrors – Processing surcharges

Modell / Art. Nr. model / item No.	Beschreibung	description
Bohrung borehole 0-07865 0-0765100	Extra Bohrung: 8 – 65 mm 65 – 100 mm	extra borehole : 8 – 65 mm 65 – 100 mm
IP 44 1-IP44	für LED spritzwassergeschützt	for LED splash proof
Schalter switch 1-00881	Schalter (verdeckt), unten mittig (verdrahtet)	switch (covered), central bottom (wired)
Schalter switch 1-00885	Einbau (Berker), chrom, vorverdrahtet, inkl. 50 mm Bohrung	flush-mounting (Berker), chrome, pre-wired, incl. 50 mm borehole
Steckdose socket 1-00882	Einbau, (Berker), chrom, vorverdrahtet, 3,5 cm Wandabstand, inkl. 50 mm Bohrung	flush mounting (Berker), chrome, pre-wired, 3.5 cm wall-spacing, including 50 mm borehole
Spiegel ... mirror ... 1-00118	... mit Magnethalterung	... with magnetic attachment
1-08777	Audio Soundsystem, integriert (Bluetooth)	Audio soundsystem, integrated (bluetooth)
1-08789	Spiegelheizung	mirror heating
1-08999	Splitterschutz	splinter protection
s. Casambi Seite s. Casambi Page	Smarthome »Casambi«	Smarthome »Casambi«
1-081330 L 300 mm 1-081340 L 400 mm 1-081350 L 500 mm 1-081360 L 600 mm 1-081380 L 800 mm 1-081390 L 900 mm 1-0813100 L 1.000 mm 1-0813120 L 1.200 mm	UV-verklebte Glasablage 130 mm tief, vorne 2 Rundecken 10 mm	UV bonded glass shelf, 130 mm depth, rounded corbers in the front 10 mm





Gestensteuerung (auf Seite 380):
Gesture Control (on page 380):



Berührungssteuerung (auf Seite 381):
Touch Control (on page 381):





Mirror Light LED

Kristallspiegel mit durchgängig leuchtendem Acryl-Rahmen und integrierter LED Beleuchtung, gefertigt nach deutscher Spiegelnorm. Erhältlich in jedem Wunschmaß.

Crystal mirror with continuously illuminated acrylic frame and integrated LED lighting, manufactured according to German mirror standards. Available in customized sizes.



Mirror Light

Bei Bestellung Höhe und Breite angeben.
Specify height and width when ordering.

H 800 x B 600 mm



29-80601

H 900 x B 700 mm



29-90701

H 1400 x B 700 mm



29-140701

H 1600 x B 700 mm



29-160701



Lichtaustritt
light emission

Mirror Light Detail



Alu Rahmenprofil

Leuchtmittel Lamps

LED ~740lm
10W/m, RA ~95



Kristallspiegel mit beleuchtetem Rahmen, inkl. Leuchtmittel.
Glazed crystal mirror with illuminated frame, including lamps.

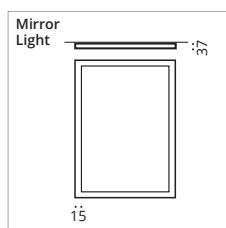

Ihr Traumspiegel ist nicht dabei?

Kein Problem – auf den Seiten 383 – 389 können Sie sich ihren Spiegel ganz individuell zusammenstellen!

Haven't found your dream mirror?

No problem – on page 383 – 389 you can design and arrange your personal mirror individually!

LED





Gestensteuerung (auf Seite 380):
Gesture Control (on page 380):

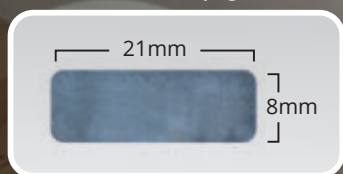

Berührungssteuerung (auf Seite 381):
Touch Control (on page 381):





Lumen Light LED

Kristallspiegel mit hochwertigem, eloxiertem Alu-Rahmen in den Oberflächen Silber, Champagner und Schwarz. Rundum integrierte LED Beleuchtung im Rahmen, gefertigt nach deutscher Spiegelnorm. Erhältlich in jedem Wunschmaß.

Crystal mirror with high-quality anodized aluminium frame in silver, champagne and black. All-round integrated LED lighting in the frame, manufactured according to German mirror standards. Available in any desired size.



Lumen Light black

Die Rahmen sind erhältlich in den Farben Silber, Champagner und Schwarz.
The frames are available in the colors silver, champagne and black.

H 800 x B 600 mm



silver
28-806020
champagne
28-806021
black
28-806022

H 900 x B 700 mm



silver
28-907020
champagne
28-907021
black
28-907022

H 1400 x B 700 mm



silver
28-1407020
champagne
28-1407021
black
28-1407022

H 1600 x B 700 mm



silver
28-1607020
champagne
28-1607021
black
28-1607022

Leuchtmittel Lamps

LED ~740lm
10W/m, RA ~95

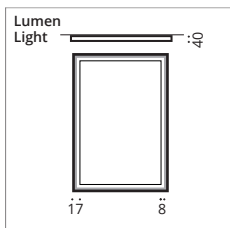

Alurahmen mit Chromverblendung am Lichtprofil.
Aluminium frame with chrom facing at the light profile.

Kristallspiegel mit beleuchtetem Rahmen, inkl. Leuchtmittel.
Glazed crystal mirror with illuminated frame, including lamps.

Ihr Traumspiegel ist nicht dabei?

Kein Problem – auf den Seiten 383 – 389 können Sie sich ihren Spiegel ganz individuell zusammenstellen!

Haven't found your dream mirror?

No problem – on page 383 – 389 you can design and arrange your personal mirror individually!

LED





Ihr Traumspiegel ist nicht dabei?

Kein Problem – auf den Seiten 383 – 389 können Sie sich ihren Spiegel ganz individuell zusammenstellen!

Haven't found your dream mirror?

No problem – on page 383 – 389 you can design and arrange your personal mirror individually!

**Gestensteuerung (auf Seite 380):
Gesture Control (on page 380):**



**Berührungssteuerung (auf Seite 381):
Touch Control (on page 381):**





Palace Light LED

Kristallspiegel mit hochwertigem, eloxiertem Alu-Rahmen in verschiedenen Oberflächen. Integrierte LED Beleuchtung im und seitlich am Rahmen, gefertigt nach deutscher Spiegelnorm.

Crystal mirror with high-quality anodised aluminium frame in various surfaces. Integrated LED lighting inside and on the side of the frame. Manufactured according to German mirror standards.



Palace Light champagne

Die Rahmen sind erhältlich in den Farben Silber, Champagner und Schwarz.
The frames are available in the colors silver, champagne and black.

H 700 x B 600 mm



silver
26-706020
champagne
26-706021
black
26-706022

H 900 x B 700 mm



silver
26-907020
champagne
26-907021
black
26-907022

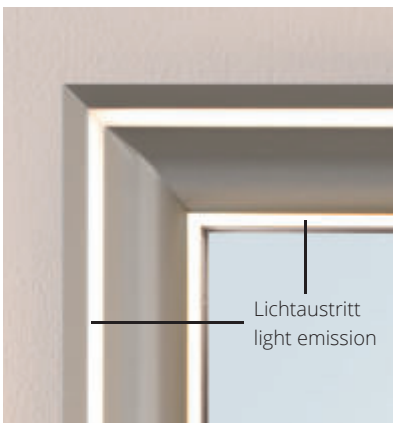

Palace Light champagne

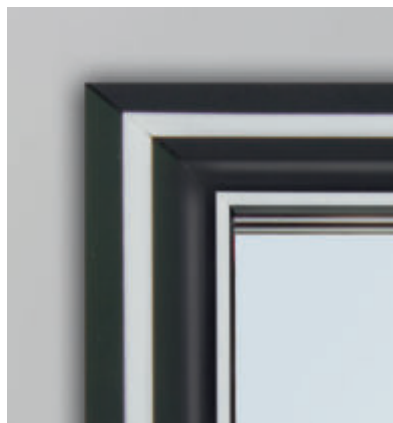

Palace Light black

H 1400 x B 700 mm



silver
26-1407020
champagne
26-1407021
black
26-1407022

H 1600 x B 700 mm



silver
26-1607020
champagne
26-1607021
black
26-1607022

BATH & WELLNESS

Leuchtmittel Lamps

LED ~1.480lm
20W/m, RA ~95



Kristallspiegel mit beleuchtetem Rahmen, inkl. Leuchtmittel.
Glazed crystal mirror with illuminated frame, including lamps.

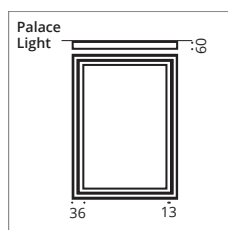



Ihr Traumspiegel ist nicht dabei?

Kein Problem – auf den Seiten 383 – 389 können Sie sich ihren Spiegel ganz individuell zusammenstellen!

Haven't found your dream mirror?

No problem – on page 383 – 389 you can design and arrange your personal mirror individually!

**Gestensteuerung (auf Seite 380):
Gesture Control (on page 380):**



**Berührungssteuerung (auf Seite 381):
Touch Control (on page 381):**





Castle Light LED

Kristallspiegel mit hochwertigem, eloxiertem Alu-Rahmen in verschiedenen Oberflächen. Integrierte LED Beleuchtung im und hinter dem Rahmen, gefertigt nach deutscher Spiegelnorm.

Crystal mirror with high-quality, anodized aluminum frame in different surfaces. Integrated LED lighting in and behind the frame, manufactured according to German mirror standards.

Dieser Spiegel kann erst ab einer minimalen Außenmaß-Länge von 510 mm gefertigt werden.

This mirror can only be manufactured from a minimum outer dimension of 510 mm.



Castle Light silver

Die Rahmen sind erhältlich in den Farben Silber, Champagner und Schwarz.
The frames are available in the colors silver, champagne and black.

H 700 x B 600 mm



silver
27-706020
champagne
27-706021
black
27-706022

H 900 x B 700 mm



silver
27-907020
champagne
27-907021
black
27-907022

H 1400 x B 700 mm



silver
27-1407020
champagne
27-1407021
black
27-1407022

H 1600 x B 700 mm



silver
27-1607020
champagne
27-1607021
black
27-1607022

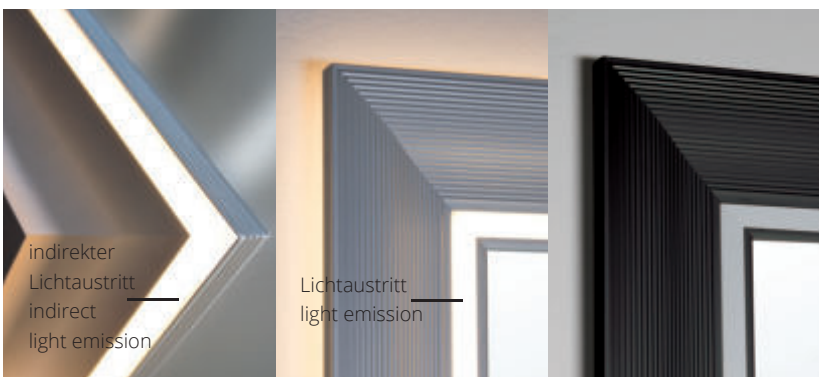

Rückansicht/rear view

Castle Light silver

Castle Light black

Leuchtmittel Lamps

LED ~1.480lm
20W/m, RA ~95



Kristallspiegel mit beleuchtetem Rahmen, inkl. Leuchtmittel.

Glazed crystal mirror with illuminated frame, including lamps.

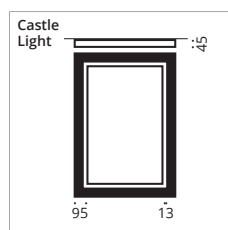

LED





Gestensteuerung (auf Seite 380):
Gesture Control (on page 380):

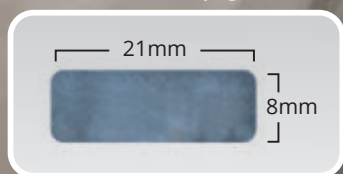

Berührungssteuerung (auf Seite 381):
Touch Control (on page 381):





Visagist LED

Standardgrößen Standard sizes

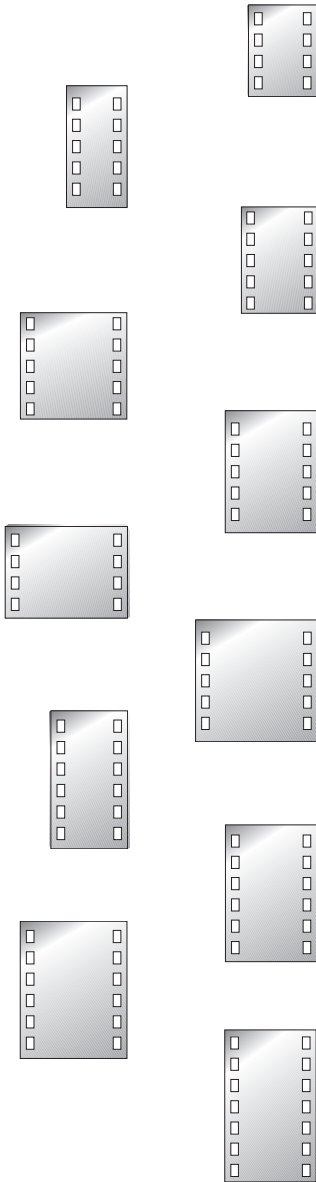

Visagist / Art. Nr. Visagist / item no.	Kristallspiegel satiniert, inkl. seitlicher Prismenabdeckung, abnehmbar crystal mirror frosted, incl. removable, lateral prism cover	Maße in mm (H x B x T) dimensions in mm (h x w x d)
1-016045-LED	20 W/m	600 x 450 x 25
1-018040-LED	20 W/m	800 x 400 x 25
1-017050-LED	20 W/m	700 x 500 x 25
1-017070-LED	20 W/m	700 x 700 x 25
1-018060-LED	20 W/m	800 x 600 x 25
1-016080-LED	20 W/m	600 x 800 x 25
1-018080-LED	20 W/m	800 x 800 x 25
1-019050-LED	20 W/m	900 x 500 x 25
1-019060-LED	20 W/m	900 x 600 x 25
1-019070-LED	20 W/m	900 x 700 x 25
1-0110060-LED	20 W/m	1000 x 600 x 25

BATH & WELLNESS

Leuchtmittel Lamps
LED
20W/m, ~1.500lm

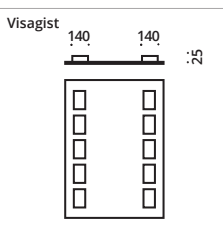
Kristallspiegel satiniert,
Kanten geschliffen und
poliert, Blockmuster, inkl.
Leuchtmittel.
Glazed crystal mirror with
smoothed and polished
edges, block pattern
design, incl. lamps.

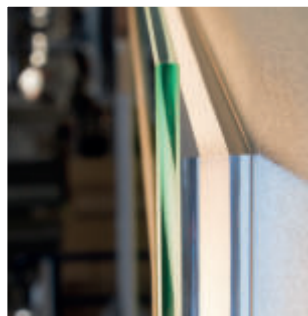

Neues Rahmenprofil eingerückt

Ihr Traumspiegel ist nicht dabei?

Kein Problem – auf den
Seiten 383 – 389 können
Sie sich ihren Spiegel
ganz individuell zusam-
menstellen!

Haven't found your
dream mirror?

No problem – on page
383 – 389 you can
design and arrange
your personal mirror
individually!

LED 





Gestensteuerung (auf Seite 380):
Gesture Control (on page 380):



Berührungssteuerung (auf Seite 381):
Touch Control (on page 381):





FineLine LED

Standardgrößen Standard sizes

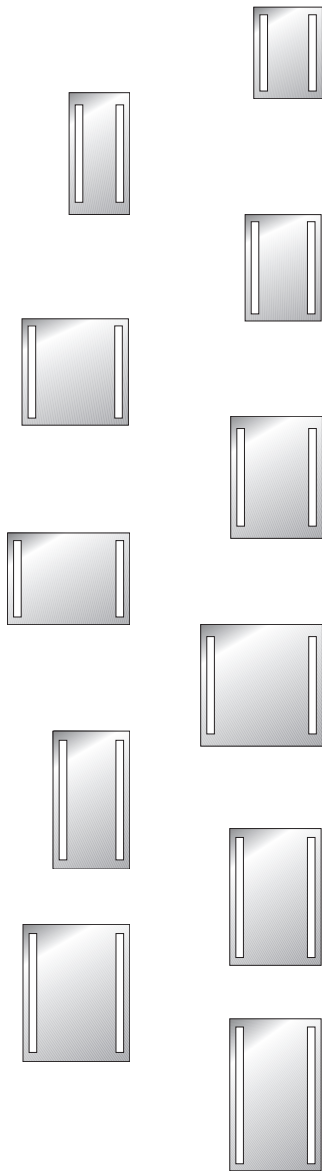

FineLine / Art. Nr. FineLine / item no.	Kristallspiegel satiniert, inkl. seitlicher Prismenabdeckung, abnehmbar Crystal mirror frosted, incl. removable, lateral prism cover	Maße in mm (H x B x T) dimensions in mm (h x w x d)
1-026045-LED	20 W/m	600 x 450 x 25
1-028040-LED	20 W/m	800 x 400 x 25
1-027050-LED	20 W/m	700 x 500 x 25
1-027070-LED	20 W/m	700 x 700 x 25
1-028060-LED	20 W/m	800 x 600 x 25
1-026080-LED	20 W/m	600 x 800 x 25
1-028080-LED	20 W/m	800 x 800 x 25
1-029050-LED	20 W/m	900 x 500 x 25
1-029060-LED	20 W/m	900 x 600 x 25
1-029070-LED	20 W/m	900 x 700 x 25
1-0210060-LED	20 W/m	1000 x 600 x 25

BATH & WELLNESS

Leuchtmittel Lamps
LED
20W/m, ~1.500lm

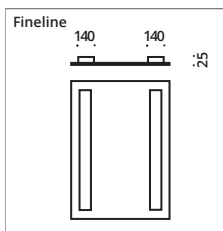

Kristallspiegel satiniert, Kanten geschliffen und poliert, Streifenmuster, inkl. Leuchtmittel. Gefertigt nach Deutscher Spiegelnorm.

Glazed crystal mirror with smoothed and polished edges, striped pattern design, incl. lamps. Manufactured according to German mirror standards.



Neues Rahmenprofil eingerückt

Ihr Traumspiegel ist nicht dabei?

Kein Problem – auf den Seiten 383 – 389 können Sie sich ihren Spiegel ganz individuell zusammenstellen!

Haven't found your dream mirror?

No problem – on page 383 – 389 you can design and arrange your personal mirror individually!

LED





Gestensteuerung (auf Seite 380):
Gesture Control (on page 380):



Berührungssteuerung (auf Seite 381):
Touch Control (on page 381):





SideLight LED

Standardgrößen Standard sizes

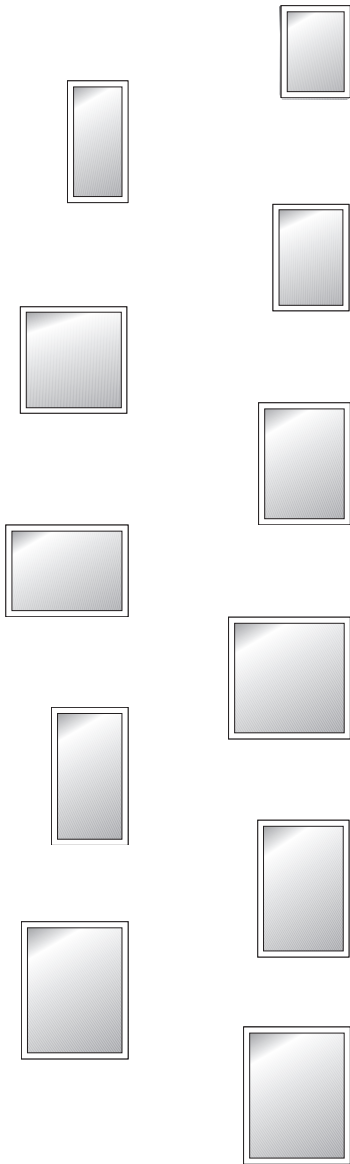

SideLight / Art. Nr. SideLight / item no.	Kristallspiegel satiniert, ohne Prismenabdeckung crystal mirror frosted, without lateral prism cover	Maße in mm (H x B x T) dimensions in mm (h x w x d)
1-036045-LED	20 W/m	600 x 450 x 25
1-038040-LED	20 W/m	800 x 400 x 25
1-037050-LED	20 W/m	700 x 500 x 25
1-037070-LED	20 W/m	700 x 700 x 25
1-038060-LED	20 W/m	800 x 600 x 25
1-036080-LED	20 W/m	600 x 800 x 25
1-038080-LED	20 W/m	800 x 800 x 25
1-039050-LED	20 W/m	900 x 500 x 25
1-039060-LED	20 W/m	900 x 600 x 25
1-039070-LED	20 W/m	900 x 700 x 25
1-0310060-LED	20 W/m	1000 x 600 x 25

BATH & WELLNESS

Leuchtmittel Lamps
LED
20W/m, ~1.500lm

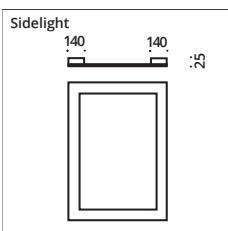

Kristallspiegel satiniert,
Kanten geschliffen und
poliert, Streifenmuster,
inkl. Leuchtmittel.

Glazed crystal mirror
with smoothed and
polished edges, striped
pattern design, including
lamps.



Neues Rahmenprofil kantenbündig

Ihr Traumspiegel ist nicht dabei?

Kein Problem – auf den
Seiten 383 – 389 können
Sie sich ihren Spiegel
ganz individuell zusam-
menstellen!

Haven't found your dream mirror?

No problem – on page
383 – 389 you can
design and arrange
your personal mirror
individually!

LED





Gestensteuerung (auf Seite 380):
Gesture Control (on page 380):

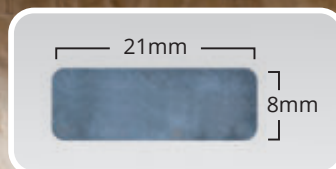

Berührungssteuerung (auf Seite 381):
Touch Control (on page 381):





DotLight LED

Standardgrößen Standard sizes

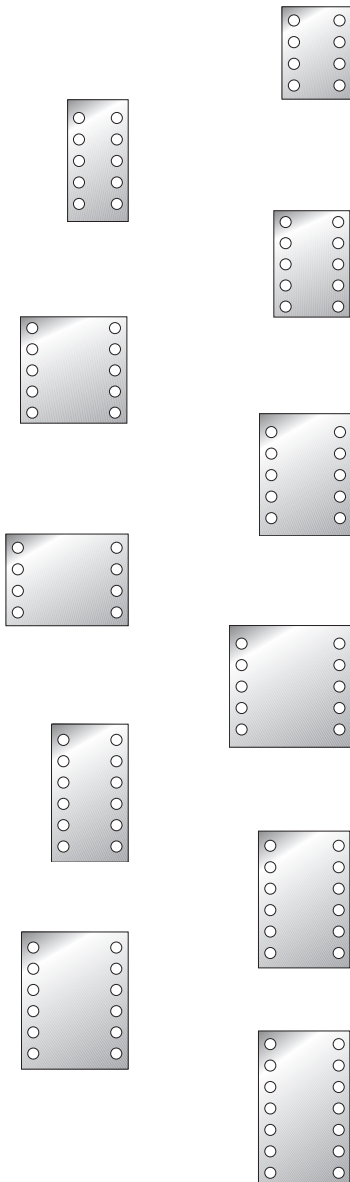

DotLight / Art. Nr. DotLight / item no.	Kristallspiegel satiniert, inkl. seitlicher Prismenabdeckung, abnehmbar crystal mirror frosted, incl. removable, lateral prism cover	Maße in mm (H x B x T) dimensions in mm (h x w x d)
1-056045-LED	20 W/m	600 x 450 x 25
1-058040-LED	20 W/m	800 x 400 x 25
1-057050-LED	20 W/m	700 x 500 x 25
1-057070-LED	20 W/m	700 x 700 x 25
1-058060-LED	20 W/m	800 x 600 x 25
1-056080-LED	20 W/m	600 x 800 x 25
1-058080-LED	20 W/m	800 x 800 x 25
1-059050-LED	20 W/m	900 x 500 x 25
1-059060-LED	20 W/m	900 x 600 x 25
1-059070-LED	20 W/m	900 x 700 x 25
1-0510060-LED	20 W/m	1000 x 600 x 25

Leuchtmittel Lamps
LED
20W/m, ~1.500lm

Satinierungs-
durchmesser
Glazing diameter
40 mm

DotLight

Kristallspiegel satiniert, Kanten
geschliffen und poliert, Punkt-
muster, inkl. Leuchtmittel.

Glazed crystal mirror with
smoothed and polished
edges, dot pattern design,
including lamps.



Neues Rahmenprofil eingerückt

Ihr Traumspiegel ist nicht dabei?

Kein Problem – auf den
Seiten 383 – 389 können
Sie sich ihren Spiegel
ganz individuell zusam-
menstellen!

Haven't found your
dream mirror?

No problem – on page
383 – 389 you can
design and arrange
your personal mirror
individually!





Gestensteuerung (auf Seite 380):
Gesture Control (on page 380):



Berührungssteuerung (auf Seite 381):
Touch Control (on page 381):





BrightLight LED

Standardgrößen Standard sizes

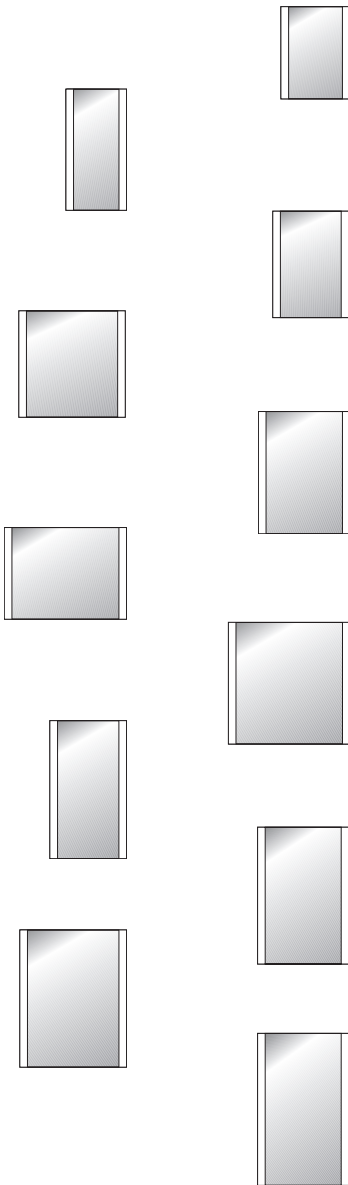

BrightLight / Art. Nr. BrightLight / item no.	Kristallspiegel satiniert, ohne Prismenabdeckung crystal mirror frosted, without lateral prism cover	Maße in mm (H x B x T) dimensions in mm (h x w x d)
1-066045-LED	20 W/m	600 x 450 x 25
1-068040-LED	20 W/m	800 x 400 x 25
1-067050-LED	20 W/m	700 x 500 x 25
1-067070-LED	20 W/m	700 x 700 x 25
1-068060-LED	20 W/m	800 x 600 x 25
1-066080-LED	20 W/m	600 x 800 x 25
1-068080-LED	20 W/m	800 x 800 x 25
1-069050-LED	20 W/m	900 x 500 x 25
1-069060-LED	20 W/m	900 x 600 x 25
1-069070-LED	20 W/m	900 x 700 x 25
1-0610060-LED	20 W/m	1000 x 600 x 25

BATH & WELLNESS

Leuchtmittel Lamps
LED
20W/m, ~1.500lm

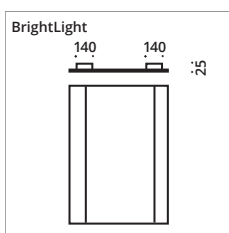

Kristallspiegel satiniert, Kanten geschliffen und poliert, Streifenmuster, inkl. Leuchtmittel.
Glazed crystal mirror with smoothed and polished edges, striped pattern, including lamps.



Neues Rahmenprofil kantenbündig

Ihr Traumspiegel ist nicht dabei?
Kein Problem – auf den Seiten 383 – 389 können Sie sich ihren Spiegel ganz individuell zusammenstellen!

Haven't found your dream mirror?
No problem – on page 383 – 389 you can design and arrange your personal mirror individually!

LED





Gestensteuerung (auf Seite 380):
Gesture Control (on page 380):



Berührungssteuerung (auf Seite 381):
Touch Control (on page 381):





InLight LED

Standardgrößen Standard sizes

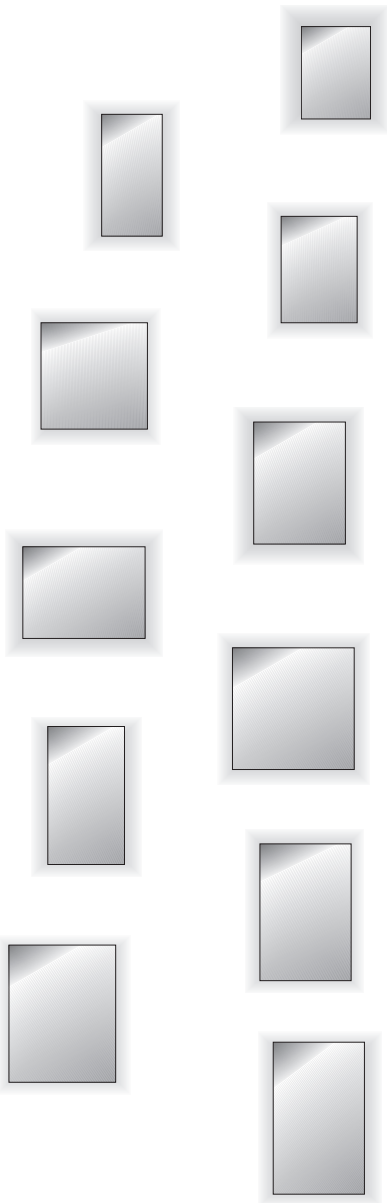

InLight / Art. Nr. InLight / item no.	Kristallspiegel ohne Prismenabdeckung crystal mirror without lateral prism cover	Maße in mm (H x B x T) dimensions in mm (h x w x d)
1-076045-LED	20 W/m	600 x 450 x 25
1-078040-LED	20 W/m	800 x 400 x 25
1-077050-LED	20 W/m	700 x 500 x 25
1-077070-LED	20 W/m	700 x 700 x 25
1-078060-LED	20 W/m	800 x 600 x 25
1-076080-LED	20 W/m	600 x 800 x 25
1-078080-LED	20 W/m	800 x 800 x 25
1-079050-LED	20 W/m	900 x 500 x 25
1-079060-LED	20 W/m	900 x 600 x 25
1-079070-LED	20 W/m	900 x 700 x 25
1-0710060-LED	20 W/m	1000 x 600 x 25

Leuchtmittel Lamps

LED
20W/m, ~1.500lm

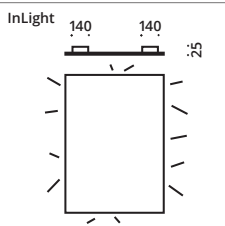

Lichtprofil eingerückt

Ihr Traumspiegel ist nicht dabei?

Kein Problem – auf den Seiten 383 – 389 können Sie sich ihren Spiegel ganz individuell zusammenstellen!

Haven't found your dream mirror?

No problem – on page 383 – 389 you can design and arrange your personal mirror individually!

LED



Hochvolt Halogen, IP 44! Leuchtmittelwartung von vorne!
High voltage halogen, IP 44! Maintenance from the front side.





BulbLine

Der klassische Halogenlichtspiegel mit seinen Lichtkugeln in Opalglasausführung bietet Ihnen viel Gestaltungsraum, um Ihre eigenen Vorstellungen perfekt umzusetzen. Designen Sie Ihren eigenen Spiegel, ganz nach Ihren Wünschen!

The classic halogen light mirror with its light bulbs in opal glass design offers you a lot of room for your creativity. Design your own mirror according to your imagination, just as you wish!



BATH & WELLNESS

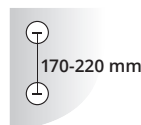

Opalglasausführung,
ø 60 mm Kugel, inkl. Bohrloch
Opal glass design
ø 60 mm bulb, incl. borehole
2-0501

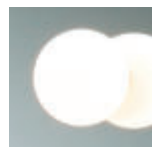

Empfohlener Abstand der Lampen zueinander: 170-220 mm,
Randabstand mind. 60 mm! Bohrloch ø = 24 mm.
Recommended spacing between lamps: 170-220 mm, edge
distance minimum 60mm! Borehole ø = 24 mm.

Opalisierte Lichtkugeln mit unsichtbarer Befestigung,
Spiegelstärke 6 mm, Wandabstand 10 mm

Opalescent light bulbs with invisible fastening,
mirror thickness 6 mm, wall spacing 10 mm.





BulbLine

Standardgrößen Standard sizes

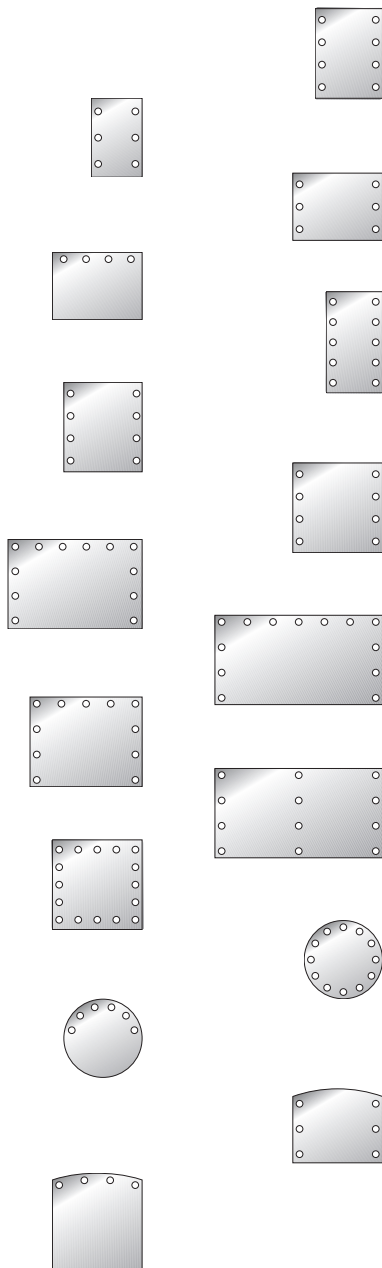

BulbLine / Art. Nr. BulbLine / item no.	Kristallspiegel mit Opalglas Lichtkugeln ohne Prismenabdeckung crystal mirror with light bulbs in opal glass without lateral prism cover	Maße in mm (H x B x T) dimensions in mm (h x w x d)
1-0480608-O	2 x 4 LS	800 x 600
1-0470456-O	2 x 3 LS	700 x 450
1-0460806-O	2 x 3 LS	600 x 800
1-0460804-O	1 x 4 LS	600 x 800
1-04806010-O	2 x 5 LS	800 x 600
1-0480708-O	2 x 4 LS	800 x 700
1-0480808-O	2 x 4 LS	800 x 800
1-048012012-O	12 LS	800 x 1200
1-048015013-O	13 LS	800 x 1500
1-048010011-O	11 LS	800 x 1000
1-048015012-O	3 x 4 LS	800 x 1500
1-04808016-O	16 LS	800 x 800
1-047012-O	12 LS	∅ 700
1-04706-O	6 LS	∅ 700
1-0465806-O-B	2 x 3 LS	650 x 800 Bogenhöhe 60 Arch rise 60
1-0485804-O-B	4 LS	850 x 800 Bogenhöhe 60 Arch rise 60

Für Zubehör siehe Seite 388-389. For Equipment see page 388-389.

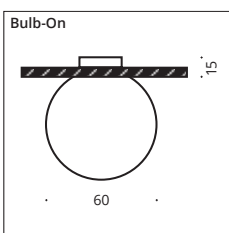

Der Wandabstand beträgt normal 10 mm. Achtung: erhöhter Wandabstand von 35 mm bei integriertem Steckdosenaufbau.

The wall spacing is normally 10 mm. Attention: Increased wall spacing with surface mounted socket (35mm)!

Leuchtmittelangabe

G9 max 20W; opt. LED

Ersatzleuchtmittel

Art. Nr. 8-205:
LED ~3W ~300lm ~2.700k





Gestensteuerung (auf Seite 380):
Gesture Control (on page 380):

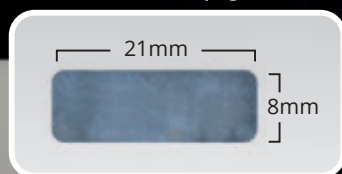

Berührungssteuerung (auf Seite 381):
Touch Control (on page 381):





Circle

Circle ist ein runder Lichtspiegel in satiniertem Kristallglas, inkl. Leuchtmittel LED oder G4 klar, gefertigt nach deutscher Spiegelnorm.

The Circle model is a round illuminated mirror made of glazed crystal glass including LED or G4 clear lamps. Manufactured according to German mirror standards.



DotCircle



SideCircle

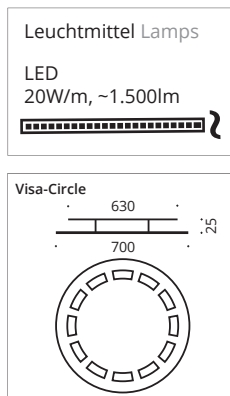

Circle / Art. Nr. Circle / item no.	Kristallspiegel satinert, ohne Prismenabdeckung Crystal mirror frosted, without lateral prism cover	Standard- größe ø mm Standard Size ø mm
VisaCircle 1-0170-LED	20 W/m	700
FineCircle 1-0270-LED	20 W/m	700
SideCircle 1-0370-LED	20 W/m	700
DotCircle 1-0570-LED	20 W/m	700
InCircle 1-0670-LED	20 W/m	700

LED **G**



Zusätzlich zur Standardgröße fertigen wir den Circle auch in Sondergrößen mit LED-Power.
In addition to the standard sizes, we also manufacture the Circle model in special sizes with LED-Power.



Gestensteuerung (auf Seite 380):
Gesture Control (on page 380):

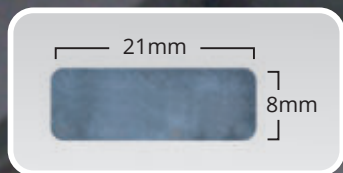

Berührungssteuerung (auf Seite 381):
Touch Control (on page 381):





Vision

- Raumteiler -

Als Visagist, FineLine und DotLight, alle Größen auf Maß, mit LED und Leuchtstofflampe T5 lieferbar.

- Room divider -

Available in the versions Visagist, FineLine and DotLight. All sizes available with LED or fluorescent lamp T5.

Modell / Art. Nr. model / item no.	Beschreibung description
Raumteiler Vision Aufbau room divider Vision surface mounting 1-00103	VA gebürstet, beidseitig beleuchtet, Lieferumfang: VA Gestänge, Befestigungsequipment, Magnethalterung und modifizierter Lichtspiegel Brushed VA, illumination on both sides. Scope of delivery: VA support, fastening equipment, magnet attachment, and modified illuminated mirror
Raumteiler Vision Einbau room divider Vision recessed mounting 1-00104	VA gebürstet, beidseitig beleuchtet, Lieferumfang: VA Gestänge, Befestigungsequipment, Magnethalterung und modifizierter Lichtspiegel Brushed VA, illumination on both sides. Scope of delivery: VA support, fastening equipment, magnet attachment, and modified illuminated mirror
Schalter switch 1-00881	verdeckter Schalter unten mittig covered switch, bottom (central)



Leuchtmittel Lamps

LED
20W/m, ~1.500lm

Raumteiler Vision

LED



Gestensteuerung (auf Seite 380):
Gesture Control (on page 380):



Berührungssteuerung (auf Seite 381):
Touch Control (on page 381):





BATH & WELLNESS

Lichtspiegel Doppelwaschtisch
Illuminated mirror double washbasin

